



**DL-100TM485S**  
**DL-100TM485PS**

**DL-100TM485S-W**  
**DL-100TM485PS-W**

IP66 Remote Temperature and Humidity Data Logger with LCD Display

### Features

- Measurement Ranges: -20 to +60 °C and 0 to 100% RH
- Accuracy:
  - ±0.4 °C; ±3.0% RH for non-P version
  - ±0.3 °C; ±1.8% RH for P version
- LCD Display shows Temperature, Humidity, Dew Point and Module ID
- 10 to 30 VDC Power Input
- IP66 Waterproof
- Data Logger can store up to 4088 Temperature and Humidity records
- RS-485 communication interface
- Modbus RTU Protocol



### Introduction

DL-100TM485S/DL-100TM485PS/DL-100TM485S-W/DL-100TM485PS-W is a temperature and humidity data logger module. It contains an RS-485 communication interface and an LCD display to show a variety of data such as: temperature, humidity, dew point and module ID. The data storage memory can store up to 4088 temperature and humidity records.

The DL Utility is included to allow installation, configuration, retrieval and display of data in a powerful chart format that can be exported to Excel.

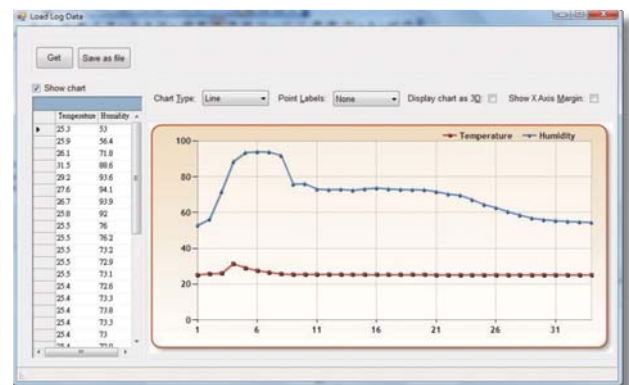

### Applications

- Transportation of food or pharmaceuticals
- Food and beverage industry (HACCP)
- Blood stations, pharmacies
- Building and energy management
- Warehouses
- Museums, archives, galleries

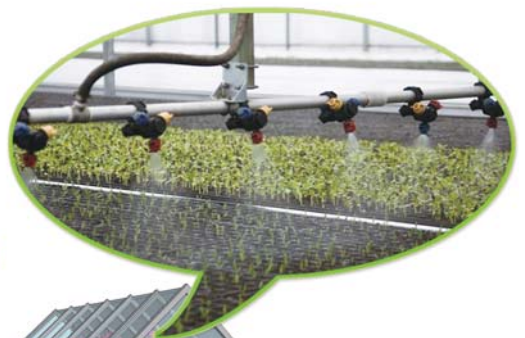

## Greenhouse Automation

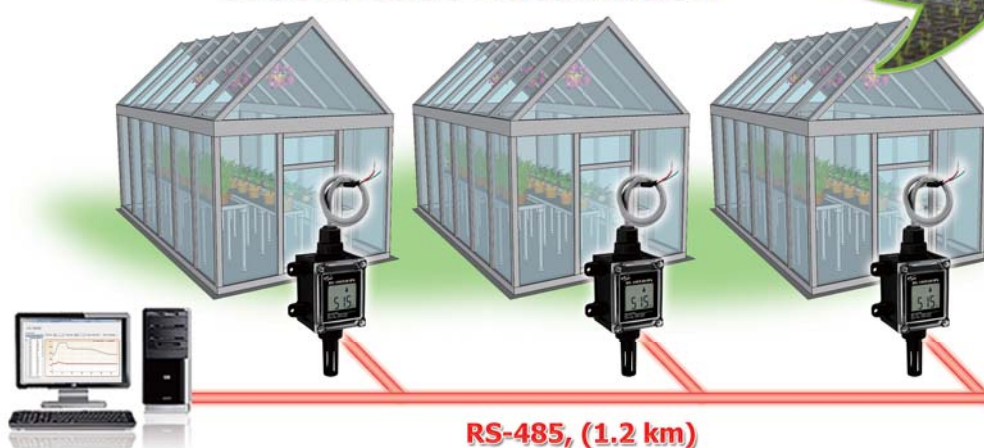

## Specifications

Models	DL-100TM485S DL-100TM485S-W	DL-100TM485PS DL-100TM485PS-W
<b>Temperature Measurement</b>		
Measuring Range	-20 to +60 °C (-4 to +140 °F)	
Resolution	0.1 °C	
Accuracy	Typical: ±0.4 °C	Typical: ±0.3 °C
Precision	±0.1 °C	
<b>Humidity Sensor</b>		
Measuring Range	0 to 100% RH	
Resolution	0.1% RH	
Accuracy	Typical: ±3% RH @ 20 to 80% RH	Typical: ±1.8% RH @ 10 to 90% RH
Precision	±0.1% RH	
<b>Dew Point</b>		
Range	Calculated using temperature and relative humidity	
Resolution	0.1 °C	
<b>LCD Display</b>		
Displayed Information	Temperature (°C and °F), Humidity (RH), Module ID	
<b>Data Logger</b>		
Time Interval	10 seconds to 1 day	
Max. Records	4088 temperature and humidity records	
Mode	Overwrite or stop logging when storage space is full	
Overwrite Limitation	1,000,000 cycles	
<b>COM Ports</b>		
Ports	1 x RS-485, Non-isolated	
Baud Rate	1200 to 115200 bps	
Data Format	N,8,1	
Protocol	Modbus RTU	Modbus RTU
<b>Power</b>		
Input Range	+10 to 30 VDC	
Power Consumption	0.15 W	
<b>Mechanical</b>		
Dimensions (W x L x H)	82 mm x 172 mm x 55 mm	
Cable Length	380 mm	
Waterproof Level	IP66	
Installation	DIN-Rail; Wall mount	
<b>Environment</b>		
Operating Temperature	-20 to +60 °C	
Storage Temperature	-30 to +80 °C	
Ambient Relative Humidity	5 to 95% RH, Non-condensing	

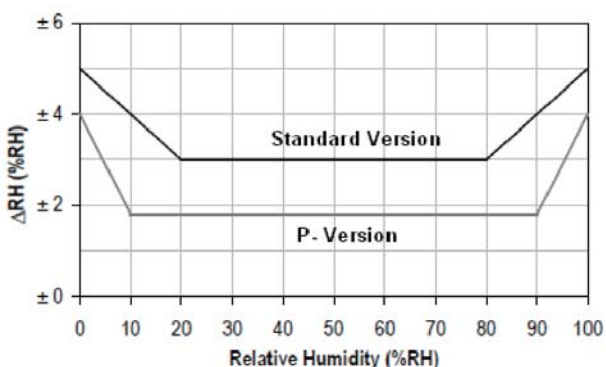

Maximum RH-tolerance at 25°C per sensor.

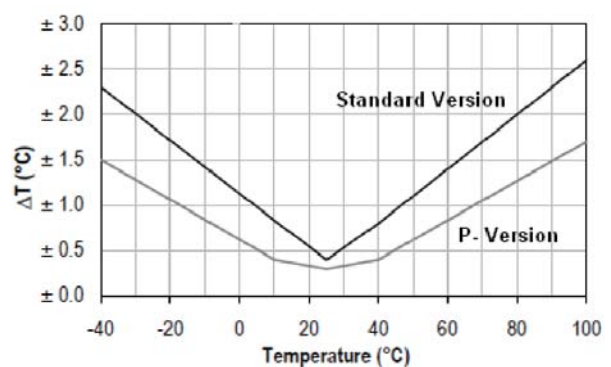

Maximum T-tolerance per sensor.

## Installation



DIN-Rail Mounting



Wall mount

## Appearance



Humidity (RH)



Module ID



Temperature (°F)



Temperature (°C)



Dew Point (°F)



Dew Point (°C)

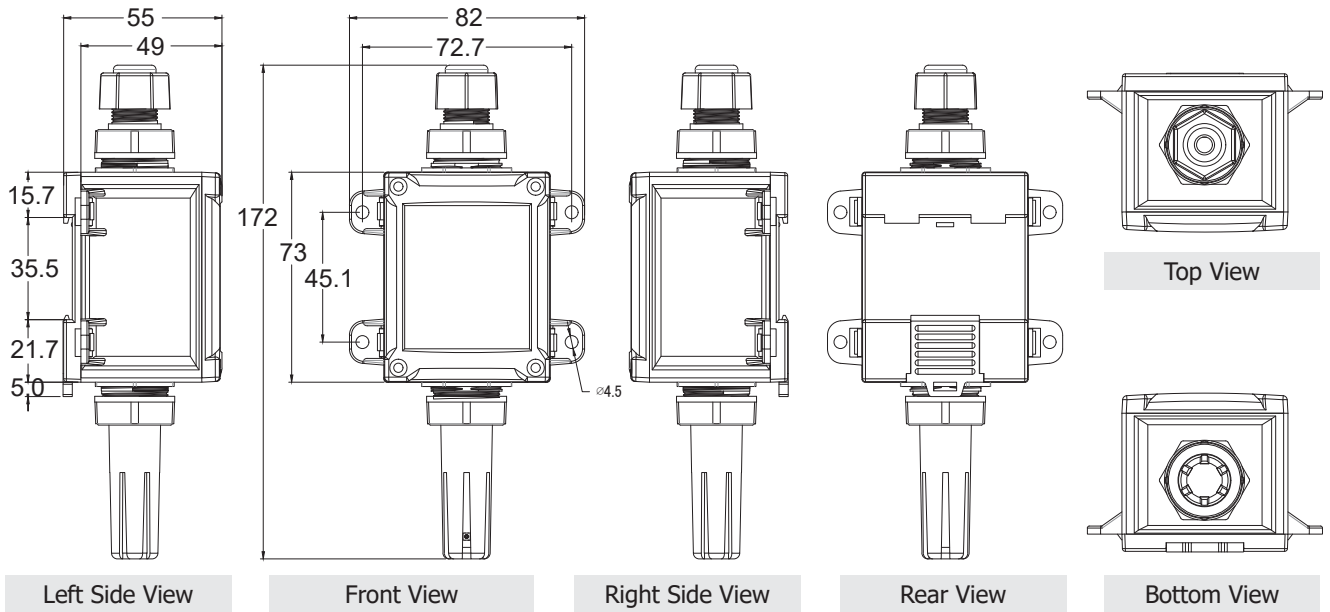

### ■ Dimensions (Units: mm)



### ■ Ordering Information

<b>DL-100TM485S CR</b>	IP66 Remote Temperature and Humidity Data Logger with LCD Display, Using Modbus RTU Protocol(Black Cover) (RoHS)
<b>DL-100TM485S-W CR</b>	DIP66 Remote Temperature and Humidity Data Logger with LCD Display, Using Modbus RTU Protocol(White Cover) (RoHS)
<b>DL-100TM485PS CR</b>	IP66 Remote Temperature and Humidity Data Logger with High Accuracy and LCD Display, Using Modbus RTU Protocol (Black Cover) (RoHS)
<b>DL-100TM485PS-W CR</b>	IP66 Remote Temperature and Humidity Data Logger with High Accuracy and LCD Display, Using Modbus RTU Protocol (White Cover) (RoHS)

### ■ Optional Accessories

tM-7561 CR 	Isolated USB to RS-485 Converter (RoHS)
tM-7520U CR 	Isolated RS-232 to RS-485 Converter (RoHS)