

MC-1100 Series Quick Installation Guide

Version 3.3, September 2021

Technical Support Contact Information
www.moxa.com/support

MOXA[®]

© 2021 Moxa Inc. All rights reserved.

P/N: 1802011000026



Overview

The Moxa MC-1100 Series DIN-rail mountable, fanless, x86 embedded computers are based on the Intel® Atom™ E3800 Series processor. These computers feature the most reliable I/O design to maximize connectivity and support multiple wireless modules (Wi-Fi/3G/LTE), making them suitable for a diverse range of communication applications.

Powered by a wide operating temperature range (-40 to 70°C) and Safety/EMI/EMS compliances, the MC-1100 Series is ideal for intelligent computing and communication solutions in critical environments, including marine communication, Oil & Gas field site monitoring, and transportation.

The MC-1100 Series comes with hardware monitoring features built in for device I/O status monitoring and alerts, system temperature monitoring and alerts, and system power management. Monitoring system status closely makes it easier to recover from errors and provides the most reliable platform for your applications.

Package Checklist

Before installing the MC-1100, verify that the package contains the following items:

- MC-1100 embedded computer
- Terminal block to power jack converter
- DIN-rail mounting kit
- Quick installation guide (printed)
- Warranty card

Please notify your sales representative if any of the above items are missing or damaged.

MC-1111 Panel Layout

The following figures show the panel layouts of the MC-1111 Series:

Top View

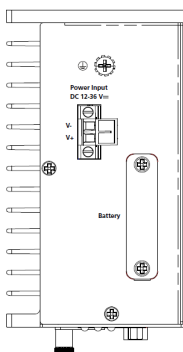

Front View

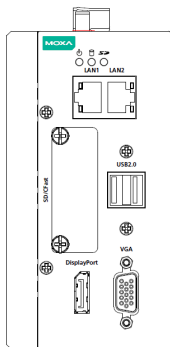

MC-1121 Panel Layout

The following figures show the panel layouts of the MC-1121 Series:

Top View

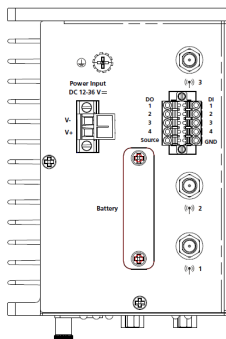

Front View

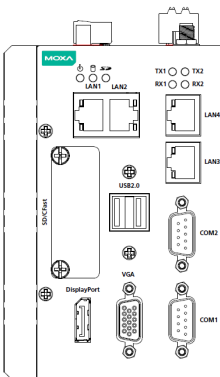

Rear View

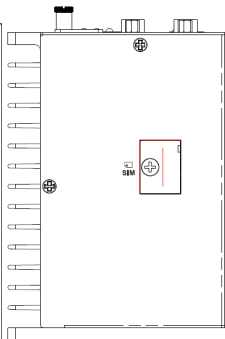

MC-1112 Panel Layout

Top View

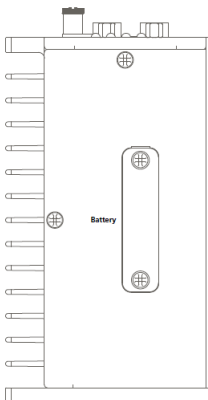

Front View

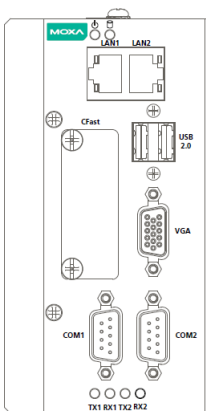

Rear View

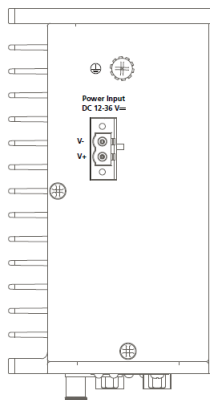

MC-1122 Panel Layout

Top View

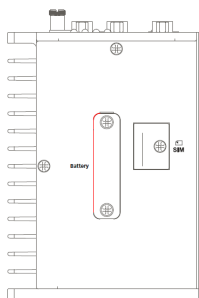

Front View

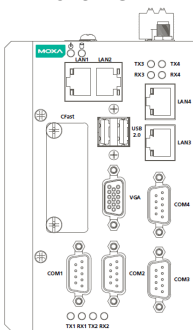

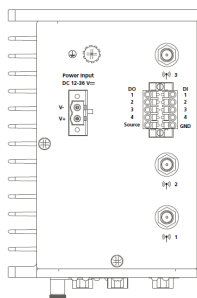

Rear View



LED Indicators

The following table describes the LED indicators located on the front panel of the MC-1100:

LED Name	Status	Description
Power 	Green	Power is on and computer is functioning normally
	Off	Power is off
Storage 1 (CFast) 	Yellow	Blinking: Data transmission
	Off	No data transmission.
Storage 2 (SD)  (MC-1111 and MC-1121 Series only)	Yellow	Blinking: Data transmission
	Off	No data transmission
LAN 1/2/3/4	Green	Steady On: 100 Mbps Ethernet link Blinking: Data is being transmitted
	Yellow	Steady On: 1000 Mbps Ethernet link Blinking: Data is being transmitted
	Off	10 Mbps Ethernet link or LAN is not connected
Tx 1/2/3/4	Green	Blinking: Data is being transmitted.
	Off	No connection
Rx 1/2/3/4	Yellow	Blinking: Data is being transmitted.
	Off	No connection

Installing a Wireless Module

Both the MC-1121 and MC-1122 models have been provided with an inbuilt Mini PCIe socket for installing a wireless module.

To install a wireless module on your MC-1100 computer, do the following:

STEP 1: Loosen the six screws on the right panel and the two screws on the bottom panel.

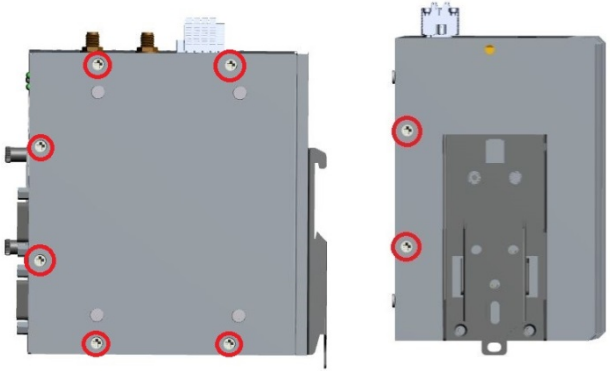

STEP 2: Open the right cover to reveal the Mini PCIe socket.



STEP 3: Insert the wireless module into the socket at an angle.

STEP 4: Push the wireless module card down.

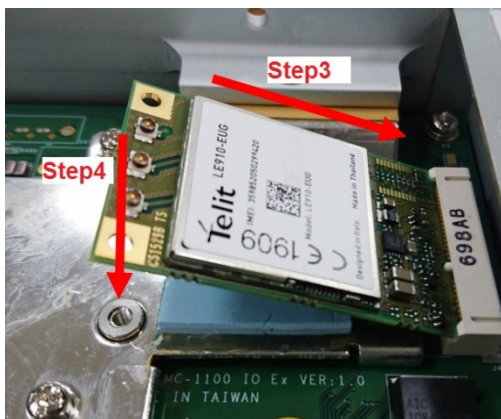

STEP 5: Secure the wireless module card with the 2 screws included in the package.

STEP 6: Connect the antenna cable connector to the wireless module card.



The available connectors are:

- Main RF antenna (ANT)
- RX Diversity Antenna (DIV)
- GNSS Antenna (GPS)

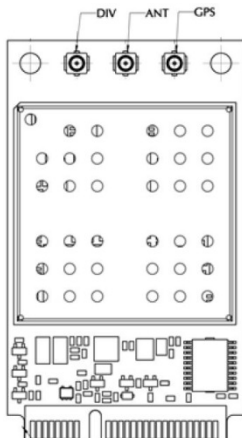

STEP 7: Replace the side and bottom covers and secure them with screws.

STEP 8: (Optional) You can install external 3G, 4G, and Wi-Fi antennas from Moxa to increase the wireless coverage. Contact a Moxa sales representative for details.

A MC-1100 computer with external antennas installed is shown here.



NOTE The MC-1121-E4-T-US model is C1D2 certified with the wireless module. The other models do not use the wireless module and hence are C1D2 certified without the wireless module.

Installing the MC-1100

DIN-rail Mounting

The MC-1100 comes with a DIN-rail mounting kit. To install the DIN-rail mounting kit, do the following:

Installation:

STEP 1:

Use the 4 screws included with the kit to attach the DIN-rail mounting bracket to the MC-1100's rear panel and tighten the screws to secure the bracket to the MC-1100.

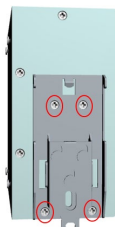

STEP 2:

Insert the top of the DIN rail into the slot just below the upper hook of the DIN-rail mounting kit.

STEP 3:

Press the MC-1100 towards the DIN rail until it snaps into place.

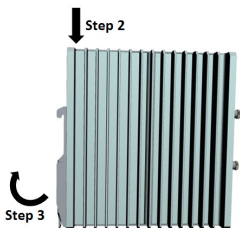
**Removal:****STEP 1:**

Pull down the latch on the mounting kit with a screwdriver.

STEP 2 & 3:

Slightly pull the MC-1100 forward and lift it up to remove it from the DIN rail.

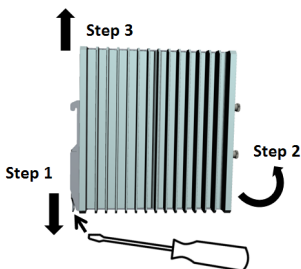
**Wall or Cabinet Mounting**

The MC-1100 can be installed on a wall by using the optional wall-mounting kit. This wall-mounting kit must be purchased separately.

STEP 1:

Use two screws for each bracket and attach the brackets to the rear of the MC-1100.

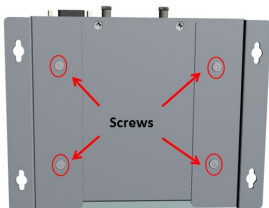
**STEP 2:**

Use two screws per side to attach the MC-1100 to a wall or cabinet.

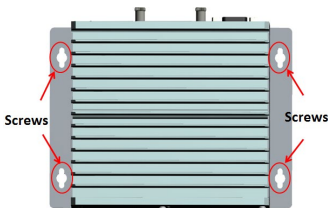
**Connector Description****Power Connector**

Power Input
DC 12-36 V \equiv

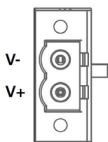

Use an LPS (12-36 VDC) or Class 2 power cord to connect to the MC-1100's terminal block to power jack converter and then turn on the power. If the power is supplied properly, the Power LED will light up. The OS is ready when the Power LED glows a solid green.

Grounding the MC-1100

Grounding and wire routing help limit the effects of noise due to electromagnetic interference (EMI). Run the ground connection from the grounding screw (M4) to the grounding surface prior to connecting the power as shown in the illustrations below:

NOTE A 4 mm² conductor must be used when the connection to the external grounding screw is utilized. The heat sink is grounded to the chassis by an internal screw.

MC-1111

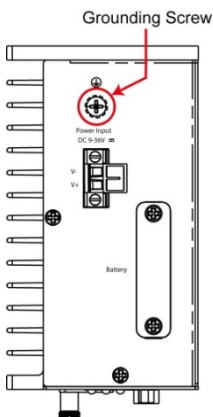

MC-1121

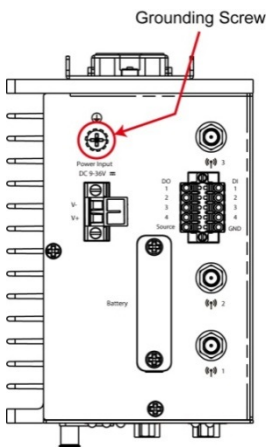

MC-1112

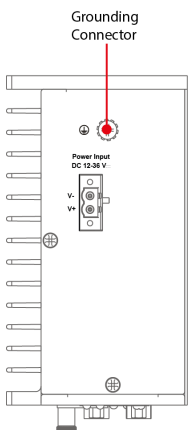

MC-1122

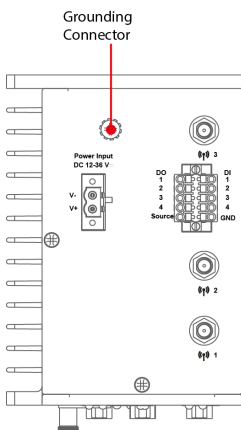

WARNING

Antenna connectors are NOT FOR USE IN HAZARDOUS LOCATIONS.

Terminal Block

Terminal block (JP1)—R/C (XCFR2, XCFR8); socket soldered on to the PWB, DINKLE ENTERPRISE CO., LTD, type 2EHDRM, rated 300 V, 15 A, 105°C. Mating with plug type 2RSDAM, 2ESDPM, 2ESDPLM or 2ESDVM, rated 300 V, 15 A, 105°C. The plug half connection is secured by screws. Suitable for 12-24 AWG wire size and secured on to a plug by screws with a torque value 0.5 N-m (4.4253 lb-in).

Ethernet Ports

The 10/100/1000 Mbps Ethernet ports use RJ45 connectors.

Pin	10/100 Mbps	1000 Mbps
1	ETx+	TRD(0)+
2	ETx-	TRD(0)-
3	ERx+	TRD(1)+
4	-	TRD(2)+
5	-	TRD(2)-
6	ERx-	TRD(1)-
7	-	TRD(3)+
8	-	TRD(3)-

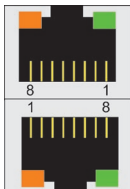

Serial Ports

The serial ports use DB9 connectors. Each port can be configured by software for RS-232, RS-422, or RS-485 port. The pin assignments for the ports are shown in the following table:

Pin	RS-232	RS-422	RS-485 (4-wire)	RS-485 (2-wire)
1	DCD	TxDA(-)	TxDA(-)	-
2	RxD	TxDB(+)	TxDB(+)	-
3	TxD	RxDB(+)	RxDB(+)	DataB(+)
4	DTR	RxDA(-)	RxDA(-)	DataA(-)
5	GND	GND	GND	GND
6	DSR	-	-	-
7	RTS	-	-	-
8	CTS	-	-	-

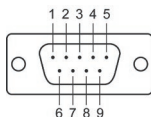

SD Slot

The MC-1100 (MC-1111 and MC-1121 Series) has an SD slot for storage expansion. The SD slot allows users to plug in an SD 3.0 standard SD card. To install an SD card, gently remove the outer cover, and then insert the SD card into the slot.

USIM Slot

The MC-1100 (MC-1121 and MC-1122 Series) has a USIM slot for 3G/LTE wireless Internet connections. To install a USIM card, gently remove the outer cover from the bottom, and then insert the USIM card into the slot.

USB Hosts

The MC-1100 has 2 USB 2.0 ports with Type A connectors (rated 5V and 700 mA total for 2 ports; max. 500 mA/port) located on the front panel. The ports support keyboard and mouse and can also be used to connect a flash disk for storing large amounts of data.

DI/DO

The MC-1100 is provided with a 2x5 terminal block that has 4 digital inputs and 4 digital outputs.

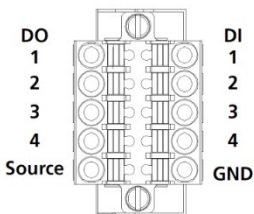

Models

MC-11WW-XX-Y-ZZZZ

WW: Function Type: can be 11 or 21 or 22 or 12

XX: Performance Type: E2 = Atom E3826, E4 = Atom E3845

Y: Operation temperature; T = wide-temperature models

ZZZZ: Application Type for marketing purpose
12-36 VDC, 2.5 A

Rating

ATEX

Information



II 3 G

DEMKO 17 ATEX 1852X

e II 3 G Ex nA IIC T4 Gc

Ambient Range: $-40^{\circ}\text{C} \leq T_a \leq +70^{\circ}\text{C}$

Rated Cable Temp. $\geq 107^{\circ}\text{C}$ for models MC-1111, MC-1112, MC-1121, and MC-1122.

IECEX

Certificate no.

IECEX UL 17.0025X

(excluding the MC-1121-E4-T-US model)

Specific Conditions of Use

1. The equipment shall be installed in an enclosure that provides a degree of protection not less than IP54 in accordance with EN 60079-15 and accessible only by the use of a tool.
2. Subject devices are for use in an area of not more than pollution degree 2 in accordance with EN 60664-1.
3. Transient protection shall be provided that is set at a level not exceeding 140 % of the peak rated voltage value at the supply terminals to the equipment.