



NEXCOM International Co., Ltd.

IoT Automation Solutions Business Group

Fan-less Computer

NISE 2400 Series

User Manual

CONTENTS

Preface

Copyright	iv
Disclaimer	iv
Acknowledgements	iv
Regulatory Compliance Statements	iv
Declaration of Conformity	iv
RoHS Compliance	v
Warranty and RMA	vi
Safety Information	viii
Installation Recommendations	viii
Safety Precautions	ix
Technical Support and Assistance	x
Conventions Used in this Manual	x
Global Service Contact Information	xi
Package Contents	xiii
Ordering Information	xiv

Chapter 1: Product Introduction

Overview	1
Hardware Specifications	2
Knowing Your NISE 2400 Series	4
Front Panel	4
Rear Panel	5
Mechanical Dimensions	6

Chapter 2: Jumpers and Connectors

Before You Begin	9
Precautions	9
Jumper Settings	10
Locations of the Jumpers and Connectors for NISB 2400	11
NISB 2400	11
Jumpers	13
CMOS Clear Select	13
ME Clear Select	13
COM3 5V/12V/RI Select	14
COM4 5V/12V/RI Select	14
3G/Wi-Fi Select	15
AT/ATX Power Select	15
Connector Pin Definitions	16
External I/O Interfaces - Front Panel	16
USB 3.0 Port	16
COM 3 and COM 4 Ports	16
CFast Card Slot	17
SIM Card Connector	17
Audio Connectors	18
LED Indicators	18
External I/O Interfaces - Rear Panel	19
9V - 30V DC Power Input	19
Remote Power On/Off Switch	19
DVI-I Connector	20



HDMI	20
LAN1 and USB 2.0 Ports.....	21
LAN2 and USB 2.0 Ports.....	21
COM 1 (RS232/422/485).....	22
COM 2 (RS232/422/485).....	22
Internal Connectors.....	23
BIOS Pin Header.....	23
SATA Connector.....	23
SATA Power Connector.....	24
Port 80 Connector.....	24
GPS Connector.....	25
CPU Fan Connector.....	25
RTC Pin Header.....	26
LAN1 LED Signal Pin Header.....	26
LAN2 LED Signal Pin Header.....	27
3G Line-out Pin Header.....	27
3G Mic-in Pin Header.....	28
Line-in Pin Header.....	28
Speaker-out Pin Header.....	29
PS2 Keyboard/Mouse Pin Header.....	29
GPIO Pin Header.....	30
MCU Flash Pin Header.....	30
Reset Button Pin Header.....	31
PWR_LED/HDD_LED/SMB_BUS/S3/SW_ON/RESET.....	31
12VSB DC-IN.....	32
Mini-PCIe Connector (3G, Wi-Fi).....	33
Mini-PCIe Connector (mSATA, Wi-Fi).....	34
PCIe x4 Slot (Only support PCIe x1 speed & signal).....	35

Chapter 3: System Setup

Removing the Bottom Cover	36
Removing the Top Cover.....	37

Installing a Mini-PCIe Module (Half-size).....	38
Installing a Mini-PCIe Module (Full-size).....	39
Installing a SO-DIMM Memory Module	40
Installing a SIM Card.....	42
Installing an Antenna.....	43
Installing a SATA Hard Drive for NISE 2400.....	45
Installing a SATA Hard Drive for NISE 2410 and NISE 2420.....	47

Chapter 4: BIOS Setup

About BIOS Setup.....	48
When to Configure the BIOS.....	48
Default Configuration.....	49
Entering Setup.....	49
Legends.....	49
BIOS Setup Utility.....	51
Main.....	51
Advanced.....	52
Chipset.....	60
Security.....	62
Boot.....	63
Save & Exit.....	64

Appendix A: Power Consumption65

Appendix B: GPI/O Programming Guide67

Appendix C: LED Programming Guide.....69

Appendix D: Watchdog Timer Setting.....70

PREFACE

Copyright

This publication, including all photographs, illustrations and software, is protected under international copyright laws, with all rights reserved. No part of this manual may be reproduced, copied, translated or transmitted in any form or by any means without the prior written consent from NEXCOM International Co., Ltd.

Disclaimer

The information in this document is subject to change without prior notice and does not represent commitment from NEXCOM International Co., Ltd. However, users may update their knowledge of any product in use by constantly checking its manual posted on our website: <http://www.nexcom.com>. NEXCOM shall not be liable for direct, indirect, special, incidental, or consequential damages arising out of the use of any product, nor for any infringements upon the rights of third parties, which may result from such use. Any implied warranties of merchantability or fitness for any particular purpose is also disclaimed.

Acknowledgements

NISE 2400, NISE 2400A, NISE 2410, NISE 2410E and NISE 2420 are trademarks of NEXCOM International Co., Ltd. All other product names mentioned herein are registered trademarks of their respective owners.

Regulatory Compliance Statements

This section provides the FCC compliance statement for Class A devices and describes how to keep the system CE compliant.

Declaration of Conformity

FCC

This equipment has been tested and verified to comply with the limits for a Class A digital device, pursuant to Part 15 of FCC Rules. These limits are designed to provide reasonable protection against harmful interference when the equipment is operated in a commercial environment. This equipment generates, uses, and can radiate radio frequency energy and, if not installed and used in accordance with the instructions, may cause harmful interference to radio communications. Operation of this equipment in a residential area (domestic environment) is likely to cause harmful interference, in which case the user will be required to correct the interference (take adequate measures) at their own expense.

CE

The product(s) described in this manual complies with all applicable European Union (CE) directives if it has a CE marking. For computer systems to remain CE compliant, only CE-compliant parts may be used. Maintaining CE compliance also requires proper cable and cabling techniques.

RoHS Compliance



NEXCOM RoHS Environmental Policy and Status Update

NEXCOM is a global citizen for building the digital infrastructure. We are committed to providing green products and services, which are compliant with European Union RoHS (Restriction on Use of Hazardous Substance in Electronic Equipment) directive 2011/65/EU, to be your trusted green partner and to protect our environment.

RoHS restricts the use of Lead (Pb) < 0.1% or 1,000ppm, Mercury (Hg) < 0.1% or 1,000ppm, Cadmium (Cd) < 0.01% or 100ppm, Hexavalent Chromium (Cr6+) < 0.1% or 1,000ppm, Polybrominated biphenyls (PBB) < 0.1% or 1,000ppm, and Polybrominated diphenyl Ethers (PBDE) < 0.1% or 1,000ppm.

In order to meet the RoHS compliant directives, NEXCOM has established an engineering and manufacturing task force to implement the introduction of green products. The task force will ensure that we follow the standard NEXCOM development procedure and that all the new RoHS components and new manufacturing processes maintain the highest industry quality levels for which NEXCOM are renowned.

The model selection criteria will be based on market demand. Vendors and suppliers will ensure that all designed components will be RoHS compliant.

How to recognize NEXCOM RoHS Products?

For existing products where there are non-RoHS and RoHS versions, the suffix "(LF)" will be added to the compliant product name.

All new product models launched after January 2013 will be RoHS compliant. They will use the usual NEXCOM naming convention.

Warranty and RMA

NEXCOM Warranty Period

NEXCOM manufactures products that are new or equivalent to new in accordance with industry standard. NEXCOM warrants that products will be free from defect in material and workmanship for 2 years, beginning on the date of invoice by NEXCOM.

NEXCOM Return Merchandise Authorization (RMA)

- Customers shall enclose the “NEXCOM RMA Service Form” with the returned packages.
- Customers must collect all the information about the problems encountered and note anything abnormal or, print out any on-screen messages, and describe the problems on the “NEXCOM RMA Service Form” for the RMA number apply process.
- Customers can send back the faulty products with or without accessories (manuals, cable, etc.) and any components from the card, such as CPU and RAM. If the components were suspected as part of the problems, please note clearly which components are included. Otherwise, NEXCOM is not responsible for the devices/parts.
- Customers are responsible for the safe packaging of defective products, making sure it is durable enough to be resistant against further damage and deterioration during transportation. In case of damages occurred during transportation, the repair is treated as “Out of Warranty.”
- Any products returned by NEXCOM to other locations besides the customers’ site will bear an extra charge and will be billed to the customer.

Repair Service Charges for Out-of-Warranty Products

NEXCOM will charge for out-of-warranty products in two categories, one is basic diagnostic fee and another is component (product) fee.

System Level

- Component fee: NEXCOM will only charge for main components such as SMD chip, BGA chip, etc. Passive components will be repaired for free, ex: resistor, capacitor.
- Items will be replaced with NEXCOM products if the original one cannot be repaired. Ex: motherboard, power supply, etc.
- Replace with 3rd party products if needed.
- If RMA goods can not be repaired, NEXCOM will return it to the customer without any charge.

Board Level

- Component fee: NEXCOM will only charge for main components, such as SMD chip, BGA chip, etc. Passive components will be repaired for free, ex: resistors, capacitors.
- If RMA goods can not be repaired, NEXCOM will return it to the customer without any charge.

Warnings

Read and adhere to all warnings, cautions, and notices in this guide and the documentation supplied with the chassis, power supply, and accessory modules. If the instructions for the chassis and power supply are inconsistent with these instructions or the instructions for accessory modules, contact the supplier to find out how you can ensure that your computer meets safety and regulatory requirements.

Cautions

Electrostatic discharge (ESD) can damage system components. Do the described procedures only at an ESD workstation. If no such station is available, you can provide some ESD protection by wearing an antistatic wrist strap and attaching it to a metal part of the computer chassis.

Safety Information

Before installing and using the device, note the following precautions:

- Read all instructions carefully.
- Do not place the unit on an unstable surface, cart, or stand.
- Follow all warnings and cautions in this manual.
- When replacing parts, ensure that your service technician uses parts specified by the manufacturer.
- Avoid using the system near water, in direct sunlight, or near a heating device.
- The load of the system unit does not solely rely for support from the rackmounts located on the sides. Firm support from the bottom is highly necessary in order to provide balance stability.
- The computer is provided with a battery-powered real-time clock circuit. There is a danger of explosion if battery is incorrectly replaced. Replace only with the same or equivalent type recommended by the manufacturer. Discard used batteries according to the manufacturer's instructions.



Danger of explosion if battery is incorrectly replaced. Replace with the same or equivalent type recommended by the manufacturer. Discard used batteries according to the manufacturer's instructions.

Installation Recommendations

Ensure you have a stable, clean working environment. Dust and dirt can get into components and cause a malfunction. Use containers to keep small components separated.

Adequate lighting and proper tools can prevent you from accidentally damaging the internal components. Most of the procedures that follow require only a few simple tools, including the following:

- A Philips screwdriver
- A flat-tipped screwdriver
- A grounding strap
- An anti-static pad

Using your fingers can disconnect most of the connections. It is recommended that you do not use needle-nose pliers to disconnect connections as these can damage the soft metal or plastic parts of the connectors.

Safety Precautions

1. Read these safety instructions carefully.
2. Keep this User Manual for later reference.
3. Disconnect this equipment from any AC outlet before cleaning. Use a damp cloth. Do not use liquid or spray detergents for cleaning.
4. For plug-in equipment, the power outlet socket must be located near the equipment and must be easily accessible.
5. Keep this equipment away from humidity.
6. Put this equipment on a stable surface during installation. Dropping it or letting it fall may cause damage.
7. The openings on the enclosure are for air convection to protect the equipment from overheating. **DO NOT COVER THE OPENINGS.**
8. Make sure the voltage of the power source is correct before connecting the equipment to the power outlet.
9. Place the power cord in a way so that people will not step on it. Do not place anything on top of the power cord. Use a power cord that has been approved for use with the product and that it matches the voltage and current marked on the product's electrical range label. The voltage and current rating of the cord must be greater than the voltage and current rating marked on the product.
10. All cautions and warnings on the equipment should be noted.
11. If the equipment is not used for a long time, disconnect it from the power source to avoid damage by transient overvoltage.
12. Never pour any liquid into an opening. This may cause fire or electrical shock.
13. Never open the equipment. For safety reasons, the equipment should be opened only by qualified service personnel.
14. If one of the following situations arises, get the equipment checked by service personnel:
 - a. The power cord or plug is damaged.
 - b. Liquid has penetrated into the equipment.
 - c. The equipment has been exposed to moisture.
 - d. The equipment does not work well, or you cannot get it to work according to the user's manual.
 - e. The equipment has been dropped and damaged.
 - f. The equipment has obvious signs of breakage.
15. Do not place heavy objects on the equipment.
16. The unit uses a three-wire ground cable which is equipped with a third pin to ground the unit and prevent electric shock. Do not defeat the purpose of this pin. If your outlet does not support this kind of plug, contact your electrician to replace your obsolete outlet.
17. **CAUTION: DANGER OF EXPLOSION IF BATTERY IS INCORRECTLY REPLACED. REPLACE ONLY WITH THE SAME OR EQUIVALENT TYPE RECOMMENDED BY THE MANUFACTURER. DISCARD USED BATTERIES ACCORDING TO THE MANUFACTURER'S INSTRUCTIONS.**

Technical Support and Assistance

1. For the most updated information of NEXCOM products, visit NEXCOM's website at www.nexcom.com.
2. For technical issues that require contacting our technical support team or sales representative, please have the following information ready before calling:
 - Product name and serial number
 - Detailed information of the peripheral devices
 - Detailed information of the installed software (operating system, version, application software, etc.)
 - A complete description of the problem
 - The exact wordings of the error messages

Warning!

1. Handling the unit: carry the unit with both hands and handle it with care.
2. Maintenance: to keep the unit clean, use only approved cleaning products or clean with a dry cloth.
3. CompactFlash: Turn off the unit's power before inserting or removing a CompactFlash storage card.

Conventions Used in this Manual



Warning:

Information about certain situations, which if not observed, can cause personal injury. This will prevent injury to yourself when performing a task.



Caution:

Information to avoid damaging components or losing data.



Note:

Provides additional information to complete a task easily.



Safety Warning: This equipment is intended for installation in a Restricted Access Location only.

Global Service Contact Information

Headquarters

NEXCOM International Co., Ltd.

9F, No. 920, Chung-Cheng Rd.,
ZhongHe District, New Taipei City, 23586,
Taiwan, R.O.C.

Tel: +886-2-8226-7786

Fax: +886-2-8226-7782

www.nexcom.com

Asia

Taiwan

NexAIoT Co., Ltd.

Taipei Office

13F, No.920, Chung-Cheng Rd.,
ZhongHe District,
New Taipei City, 23586, Taiwan, R.O.C.

Tel: +886-2-8226-7796

Fax: +886-2-8226-7792

Email: sales@nexcom.com.tw

www.nexcom.com.tw

NexAIoT Co., Ltd.

Taichung Office

16F, No.250, Sec. 2, Chongde Rd.,
Beitun Dist.,

Taichung City 406, R.O.C.

Tel: +886-4-2249-1179

Fax: +886-4-2249-1172

Email: sales@nexcom.com.tw

www.nexcom.com.tw

NexCOBOT Taiwan Co., Ltd.

13F, No.916, Chung-Cheng Rd.,
ZhongHe District,
New Taipei City, 23586, Taiwan, R.O.C.

Tel: +886-2-8226-7796

Fax: +886-2-8226-7792

Email: sales@nexcom.com.tw

www.nexcom.com.tw

GreenBase Technology Corp.

13F, No.922, Chung-Cheng Rd.,
Zhonghe Dist.,
New Taipei City, 23586, Taiwan, R.O.C.

Tel: +886-2-8226-7786

Fax: +886-2-8226-7900

Email: sales@nexcom.com.tw

www.nexcom.com.tw

China

NEXSEC Incorporated

Floor 5, No.4, No.7 fengxian middle Rd.,
(Beike Industrial Park), Haidian District,
Beijing, 100094, China

Tel: +86-10-5704-2680

Fax: +86-10-5704-2681

Email: sales@nexcom.cn

www.nexcom.cn

NEXCOM Shanghai

Room 603/604, Huiyinmingzun Plaza Bldg., 1,
No. 609, Yunlin East Rd.,
Shanghai, 200062, China
Tel: +86-21-5278-5868
Fax: +86-21-3251-6358
Email: sales@nexcom.cn
www.nexcom.cn

NEXCOM Surveillance Technology Corp.

Floor 5, Building C, ZhenHan Industrial Zone,
GanKeng Community, Buji Street,
LongGang District,
ShenZhen, 518112, China
Tel: +86-755-8364-7768
Fax: +86-755-8364-7738
Email: steveyang@nexcom.com.tw
www.nexcom.cn

NEXCOM United System Service

Room 603/604, Huiyinmingzun Plaza Bldg. 1,
No. 609, Yunlin East Rd.,
Shanghai, 200062, China
Tel: +86-21-5278-5868
Fax: +86-21-3251-6358
Email: renwang@nexcom.com.tw
www.nexcom.cn

NEXGOL

1st Floor, Building B4, Electronic 2nd Area,
(Phoenix Lake Industrial Park), Yongchuan Dist.,
Chongqing City, 402160, China
Tel: +86-23-4960-9080
Fax: +86-23-4966-5855
Email: sales@nexcobot.com
www.nexgol.com/NexGoL

Beijing NexGemo Technology Co.,Ltd.

5th Floor, Gemotech Building, No.1, Development Rd.,
Changping International Information Industry Base,
Changping District,
Beijing, 102206, China
Tel: +86-10-8190-9399
Fax: +86-10-8190-9456

Japan**NEXCOM Japan**

9F, Tamachi Hara Bldg.,
4-11-5, Shiba Minato-ku,
Tokyo, 108-0014, Japan
Tel: +81-3-5419-7830
Fax: +81-3-5419-7832
Email: sales@nexcom-jp.com
www.nexcom-jp.com

Europe**United Kingdom
NEXCOM EUROPE**

10 Vincent Avenue,
Crownhill Business Centre,
Milton Keynes, Buckinghamshire
MK8 0AB, United Kingdom
Tel: +44-1908-267121
Fax: +44-1908-262042
Email: sales.uk@nexcom.eu
www.nexcom.eu

**America
USA****NEXCOM USA**

2883 Bayview Drive,
Fremont CA 94538, USA
Tel: +1-510-656-2248
Fax: +1-510-656-2158
Email: sales@nexcom.com
www.nexcom.com

Package Contents

Before continuing, verify that the NISE 2400 package that you received is complete. Your package should have all the items listed in the following table.

Item	Part Number	Description	Qty
1	6012200052X00	PE Zipper Bag #8	1
2	60177A0362X00	(E)NISE 2400 Quick Reference Guide VER:A Size:A4	1
3	7800000078X00	DVI-I to VGA Adapter for NISE 104 ST:ADDH27B	1
4	6012200053X00	PE Zipper Bag #3	2
5	50311F0326X00	Flat Head Screw Long Fei:F3x5 Nylok NI+Heat Treatment	4
6	50311F0330X00	Round Head Screw Long Fei:P2x3 ISO+Nylon	4
7	4NCPM00203X00	Terminal Blocks 2P Phoenix Contact:1803578	1
8	4NCPM00302X00	(T)Terminal Blocks 3P Phoenix Contact:1777992	1
9	5060900226X00	Mini-PCIe Bracket CHYUAN-JYH	1
10	50311F0295X00	Flat Head Screw Long Fei:F2x4 Nylok NIGP	2
11	602DCD1054X00	(E)NISE 2400 DVD Driver VER:1.0	1

Ordering Information

The following information below provides ordering information for the NISE 2400 series.

- **Barebone**

NISE 2400 (P/N:10J00240000X0, by request)

- Onboard Intel® Atom™ processor E3827 Dual Core, 1.75GHz

NISE 2400-J1900 (P/N:10J00240002X0)

- Onboard Intel® Celeron® processor J1900 Quad Core, 2.0GHz

NISE 2410 (P/N: 10J00241000X0, by request)

- Onboard Intel® Atom™ processor E3827 Dual Core, 1.75GHz with one PCI expansion

NISE 2410-J1900 (P/N:10J00241002X0)

- Onboard Intel® Celeron® processor J1900 Quad Core, 2.0GHz with one PCI expansion

NISE 2410E (P/N: 10J00241001X0, by request)

- Onboard Intel® Atom™ processor E3845 Quad Core, 1.91GHz with one PCIe x4 expansion

NISE 2410E-J1900 (P/N: 10J00241005X0)

- Onboard Intel® Celeron® processor J1900 Quad Core, 2.0GHz with one PCIe x4 expansion

NISE 2420 (P/N: 10J00242000X0, by request)

- Onboard Intel® Atom™ processor E3845 Quad core, 1.91GHz with two PCI expansions

NISE 2400A (P/N:10J00240001X0, by request)

- Onboard Intel® Atom™ processor E3827 Dual Core, 1.75GHz

NISE 2420-J1900 (P/N: 10J00242001X0)

- Onboard Intel® Celeron® processor J1900 Quad Core, 2.0GHz with two PCI expansions

- **24V 60W AC/DC power adapter w/o power cord (P/N: 7400060033X00)**



Optional Power Adapter: Please use an appropriate AC/DC power adapter compliant with CE or UL safety regulations.

CHAPTER 1: PRODUCT INTRODUCTION

Overview



NISE 2400 Front View



NISE 2400 Rear View



NISE 2410 Front View



NISE 2410 Rear View



NISE 2420 Front View



NISE 2420 Rear View

Key Features

- Onboard Intel® Atom™ processor E3827 Dual Core, 1.75GHz (NISE 2400/NISE 2410/NISE 2400A)
- Onboard Intel® Atom™ processor E3845 Quad Core, 1.91GHz (NISE 2410E/NISE 2420)
- Onboard Intel® Celeron® Processor J1900 Quad Core, 2.0GHz (NISE 2400-J1900/NISE 2410-J1900/NISE 2410E-J1900/NISE 2420-J1900)
- Dual independent display from DVI-I and HDMI
- 2x Intel® I210IT GbE LAN ports support WoL, Teaming and PXE
- 4x USB 2.0 & 1 x USB 3.0
- 2x RS232 & 2x RS232/RS422/RS485 Auto
- 2x Mini-PCIe socket for optional mSATA/Wi-Fi/4G LTE/3.5G
- Support -20 to 70 degrees Celsius extended operating temperature (NISE 2400-J1900/NISE 2410-J1900 only support -5 to 55 degrees Celsius)
- Support 9-30V DC input

Hardware Specifications

CPU Support

- Onboard Intel® Celeron® processor J1900 Quad Core, 2.0GHz
- Onboard Intel® Atom™ processor E3827 Dual Core, 1.75GHz
- Onboard Intel® Atom™ processor E3845 Dual Core, 1.91GHz
- Support Intel® Atom™ E3800 processor family from single core E3815, dual core E3825/E3826/E3827 and quad core E3845 with different SKUs

Main Memory

- 2x DDR3L SO-DIMM socket, support DDR3L 1066/1333 8GB RAM max., un-buffered and non-ECC

Display Option

- Dual independent display
 - HDMI and DVI-I
 - HDMI and VGA (via DVI-I connector)

Front I/O Interface

- ATX power on/off switch
- 1x Power Status, 1x HDD access, 1x battery low, 4x programming LEDs, 4x Tx/Rx LEDs, 2x LAN LEDs
- 2x DB9 RS232 for COM3 & COM4
- 1x External CFast socket
- 1x SIM card holder
- 1x USB 3.0 (900mA per each)
- 1x Mic-in & 1x Line-out
- 2x antenna holes for optional Wi-Fi/3.5G antenna

Rear I/O Interface

- 4x USB 2.0
- 1x DVI-I display output
- 1x HDMI display output
- 1x remote power on/off switch
- 2x Intel® I210IT GbE LAN ports, support wake on LAN, Teaming and PXE
- 2x DB9 for COM1 & COM2, both support RS232/422/485 with auto flow control
 - Jumper-free setting on RS232/422/485
- 1x 3-pin DC input, support +9 to 30VDC input

I/O Interface - Internal

- 4x GPI and 4 GPO (5V, TTL Type)

Storage Device

- 1x CFast card socket (SATA 2.0)
- 1x 2.5" HDD space (SATA 2.0)
- 1x mSATA from mini-PCI socket if SATA HDD is not installed

Expansion Slot

- 2x Mini-PCIe socket for optional Wi-Fi/4G LTE/3.5G
- NISE 2410: One PCI Expansion
 - Add-on card length: 176mm max.
 - Power consumption: 10W/ slot max.
- NISE 2410E: One PCIe x4 Expansion (only support PCIe x1 speed & signal)
 - Add-on card length: 176mm max.
 - Power consumption: 10W/ slot max.

- NISE 2420: Two PCI Expansion
 - Add-on card length: 176mm max.
 - Power consumption: 10W/ slot max.

Power Requirement

- Power input: +9Vdc to +30Vdc
- 1x optional 24V, 60W power adapter

Dimensions

- NISE 2400: 191mm (W) x 200mm (D) x 60mm (H) without wall-mount bracket
- NISE 2410/2410E: 195mm (W) x 200mm (D) x 90mm (H) without wall-mount bracket
- NISE 2420: 195mm (W) x 200mm (D) x 111mm (H) without wall-mount bracket

Construction

- Aluminum and metal chassis with fanless design

Environment

- Operating Temperature:
Ambient with air flow: -20°C to 70°C
(According to IEC60068-2-1, IEC60068-2-2, IEC60068-2-14)
- Storage temperature: -30°C to 85°C
- Relative humidity: 10% to 95% (non-condensing)
- Shock Protection:
 - HDD: 20G, half sine, 11ms, IEC60068-2-27
 - CFast: 50G, half sine, 11ms, IEC60068-2-27

- Vibration Protection w/ HDD Condition:
 - Random: 0.5Grms @ 5 ~ 500Hz, IEC60068-2-64
 - Sinusoidal: 0.5Grms @ 5 ~ 500Hz, IEC60068-2-6
- Vibration Protection w/ CFast & SSD Condition:
 - Random: 2Grms @ 5 ~ 500Hz, IEC60068-2-64
 - Sinusoidal: 2Grms @ 5 ~ 500Hz, IEC60068-2-6

Certifications

- CE
- FCC Class A

OS Support List

- Windows 8, 32-bit/64-bit
- Windows Embedded Standard 8, 32-bit/64-bit
- Windows 7, 32-bit/64-bit
- Windows Embedded Standard 7, 32-bit/64-bit
- Linux Kernel version 3.8.0

Knowing Your NISE 2400 Series

Front Panel

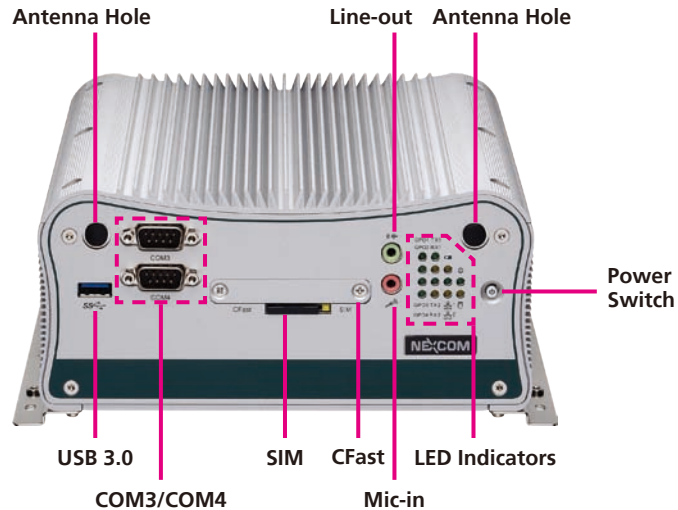

Antenna Hole

Used to install external antennas.

USB 3.0

USB 3.0 port to connect the system with USB 3.0/2.0 devices.

COM 3 and COM 4

Two DB9 ports used to connect RS232 compatible devices.

SIM

Used to insert a SIM card.

CFast Socket

Used to insert a CFast card.

Line-out

Used to connect a headphone or a speaker.

Mic-in

Used to connect an external microphone.

LED Indicators

Indicates the power status, hard drive (CFast), RTC battery, LAN1/2, COM1/2 and GPO activity of the system.

Power Switch

Press to power-on or power-off the system.

Rear Panel

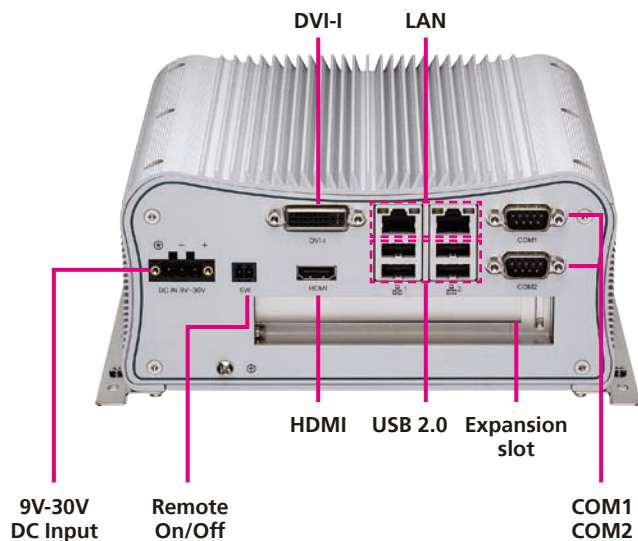

9V-30V DC Input

Used to plug a DC power cord.

Remote On/Off Switch

Used to connect a remote to power on/off the system.

DVI-I

Used to connect a digital LCD panel.

HDMI

Used to connect a high-definition display.

LAN

Dual Gigabit LAN ports to connect the system to a local area network.

USB 2.0

Used to connect USB 2.0/1.1 devices.

COM 1 and COM 2

Two DB9 ports used to connect RS232/422/485 compatible devices.

Expansion Slot

NISE 2400: N/A

NISE 2410: One PCI expansion slot

NISE 2410E: One PCIe x4 expansion slot (only support PCIe x1 speed and signal)

NISE 2420: Two PCI expansion slots

Mechanical Dimensions

NISE 2400

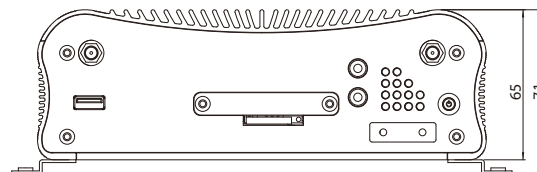
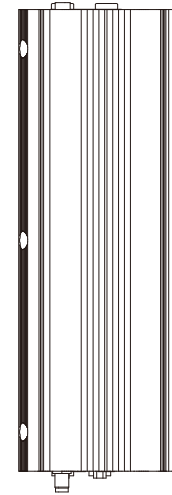
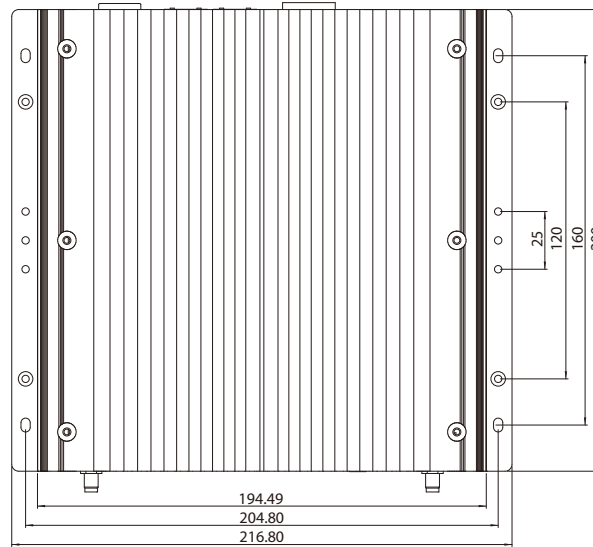
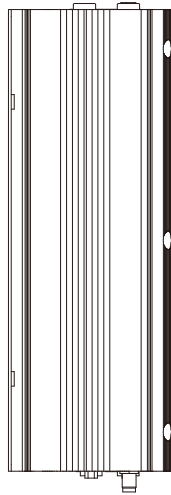
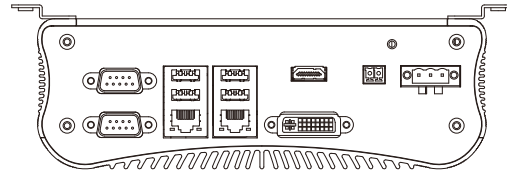

NISE 2410 and NISE 2410E

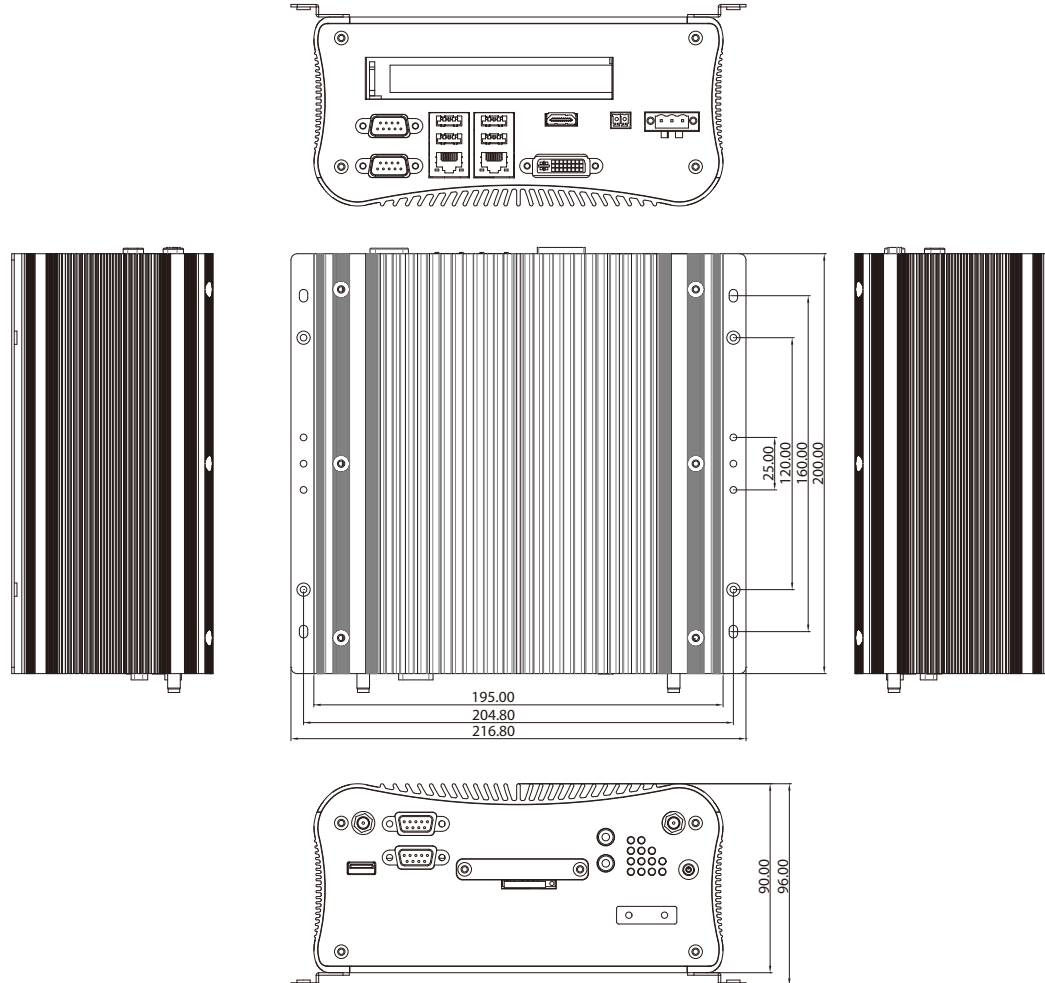

NISE 2420

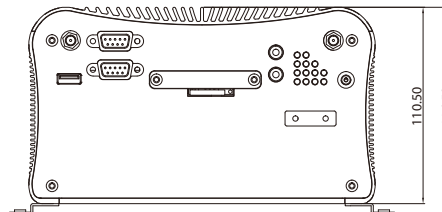
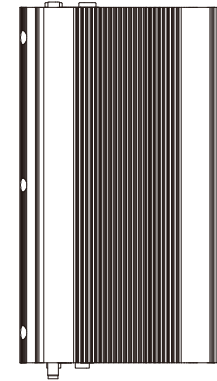
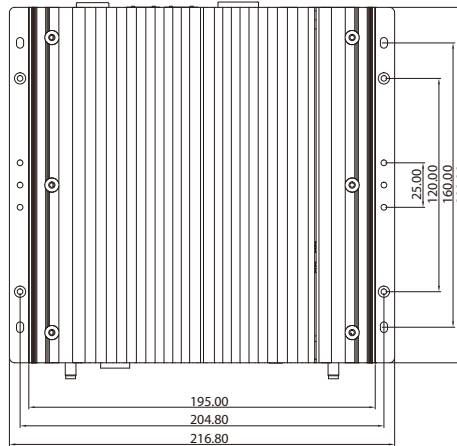
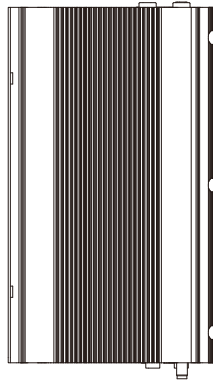
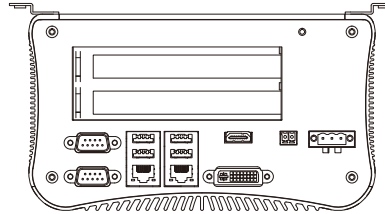

CHAPTER 2: JUMPERS AND CONNECTORS

This chapter describes how to set the jumpers and connectors on the NISE 2400 series motherboard.

Before You Begin

- Ensure you have a stable, clean working environment. Dust and dirt can get into components and cause a malfunction. Use containers to keep small components separated.
- Adequate lighting and proper tools can prevent you from accidentally damaging the internal components. Most of the procedures that follow require only a few simple tools, including the following:
 - A Philips screwdriver
 - A flat-tipped screwdriver
 - A set of jewelers screwdrivers
 - A grounding strap
 - An anti-static pad
- Using your fingers can disconnect most of the connections. It is recommended that you do not use needle-nosed pliers to disconnect connections as these can damage the soft metal or plastic parts of the connectors.
- Before working on internal components, make sure that the power is off. Ground yourself before touching any internal components, by touching a metal object. Static electricity can damage many of the electronic components. Humid environments tend to have less static electricity than

dry environments. A grounding strap is warranted whenever danger of static electricity exists.

Precautions

Computer components and electronic circuit boards can be damaged by discharges of static electricity. Working on computers that are still connected to a power supply can be extremely dangerous.

Follow the guidelines below to avoid damage to your computer or yourself:

- Always disconnect the unit from the power outlet whenever you are working inside the case.
- If possible, wear a grounded wrist strap when you are working inside the computer case. Alternatively, discharge any static electricity by touching the bare metal chassis of the unit case, or the bare metal body of any other grounded appliance.
- Hold electronic circuit boards by the edges only. Do not touch the components on the board unless it is necessary to do so. Don't flex or stress the circuit board.
- Leave all components inside the static-proof packaging that they shipped with until they are ready for installation.
- Use correct screws and do not over tighten screws.

Jumper Settings

A jumper is the simplest kind of electric switch. It consists of two metal pins and a cap. When setting the jumpers, ensure that the jumper caps are placed on the correct pins. When the jumper cap is placed on both pins, the jumper is short. If you remove the jumper cap, or place the jumper cap on just one pin, the jumper is open.

Refer to the illustrations below for examples of what the 2-pin and 3-pin jumpers look like when they are short (on) and open (off).

Two-Pin Jumpers: Open (Left) and Short (Right)

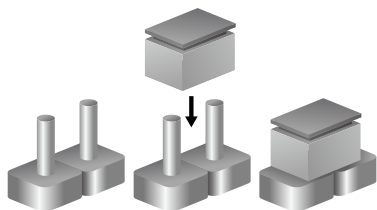

Three-Pin Jumpers: Pins 1 and 2 are Short

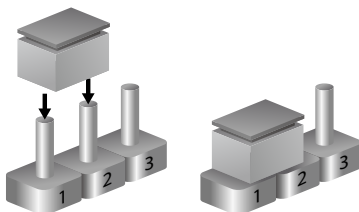

Locations of the Jumpers and Connectors for NISB 2400

NISB 2400

The figure below is the top view of the NISB 2400 main board which is the main board used in the NISE 2400 series. It shows the locations of the jumpers and connectors.

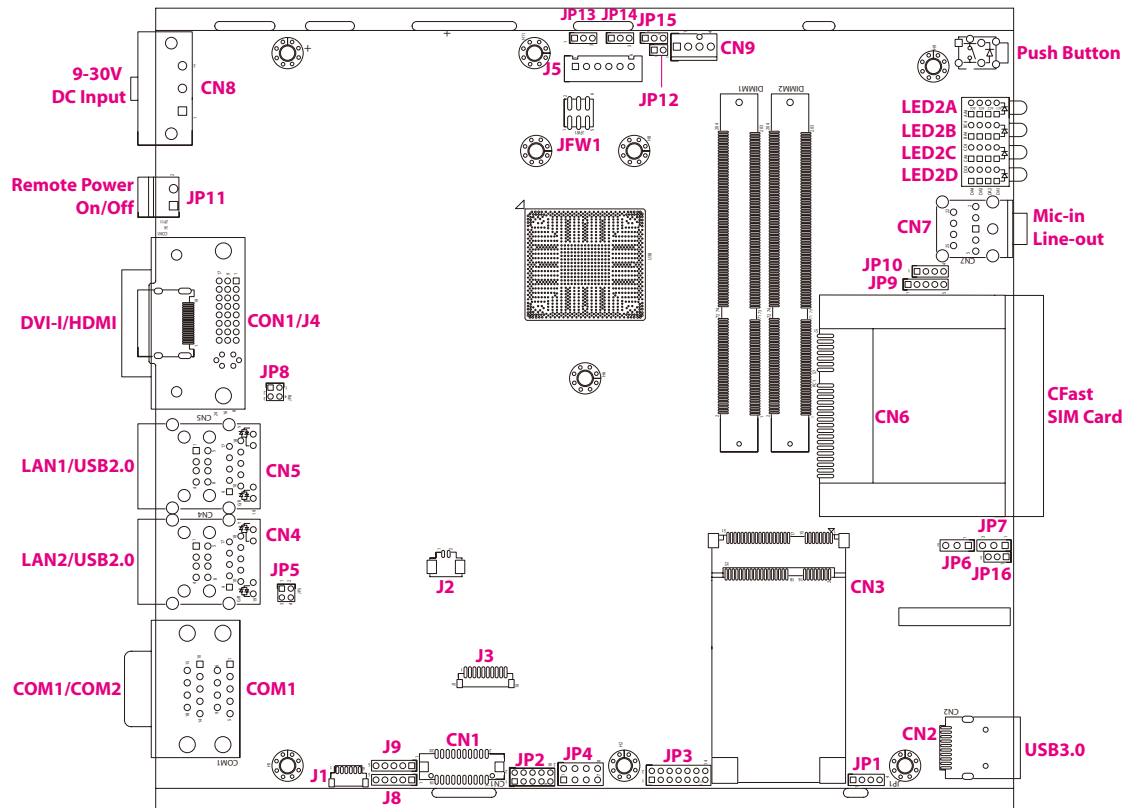

The figure below is the bottom view of the NISB 2400 main board.

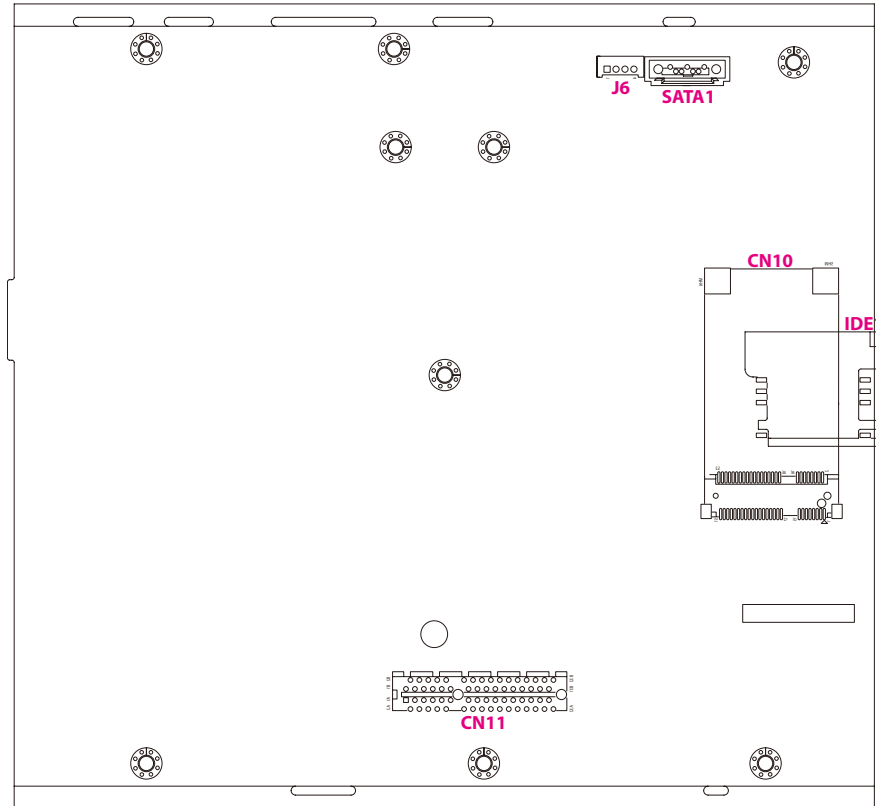

Jumpers

CMOS Clear Select

Connector type: 1x3 3-pin header, 2.0mm pitch
Connector location: JP13



Pin	Settings
1-2 On	Normal
2-3 On	Clear CMOS

1-2 On: default

Pin	Definition
1	NC
2	RTC_TEST#
3	GND

ME Clear Select

Connector type: 1x3 3-pin header, 2.0mm pitch
Connector location: JP14



Pin	Settings
1-2 On	Normal
2-3 On	Clear ME

1-2 On: default

Pin	Definition
1	NC
2	SRTC_TEST#
3	GND

COM3 5V/12V/RI Select

Connector type: 1x5 5-pin header, 2.0mm pitch
Connector location: J8



Pin	Settings
1-2 On	VCC5
2-3 On	VCC12
4-5 On	RI Mode

4-5 On: default

Pin	Definition
1	VCC5
2	SP3_RI_T
3	VCC12
4	SP3_RI_T
5	SP3_RI

COM4 5V/12V/RI Select

Connector type: 1x5 5-pin header, 2.0mm pitch
Connector location: J9



Pin	Settings
1-2 On	VCC5
2-3 On	VCC12
4-5 On	RI Mode

4-5 On: default

Pin	Definition
1	VCC5
2	SP4_RI_T
3	VCC12
4	SP4_RI_T
5	SP4_RI

3G/Wi-Fi Select

Connector type: 1x3 3-pin header, 2.0mm pitch

Connector location: JP16



Pin	Settings
1-2 On	3G Mode
2-3 On	Wi-Fi Mode

2-3 On: default

Pin	Definition
1	3VSB
2	WIFI_3G_OE
3	GND

AT/ATX Power Select

Connector type: 1x3 3-pin header, 2.0mm pitch

Connector location: JP15



Pin	Settings
1-2 On	AT Mode
2-3 On	ATX Mode

2-3 On: default

Pin	Definition
1	3VSB
2	AT/ATX_SEL
3	GND

Connector Pin Definitions

External I/O Interfaces - Front Panel

USB 3.0 Port

Connector type: USB 3.0 port
 Connector location: CN2

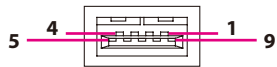

COM 3 and COM 4 Ports

Connector type: DB-9 port, 9-pin D-Sub
 2x10 20-pin header, 1.25mm pitch
 Connector location: CN1 (Internal)

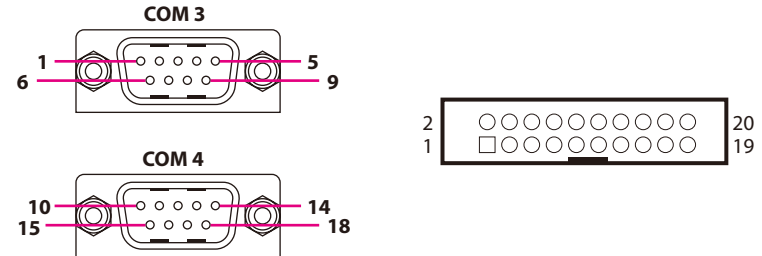

Pin	Definition	Pin	Definition
1	P5V_OC01_C	2	USB_ON_C
3	USB_OP_C	4	GND
5	USB3_RX0_N_C	6	USB3_RX0_P_C
7	GND	7A	GND
8	USB3_TX0_N_C	9	USB3_TX0_P_C
MH1	CHASSIS_GND	MH2	CHASSIS_GND

CN1 Pin Definition

Pin	Definition	Pin	Definition
1	SP3_DCD	2	SP4_DCD
3	SP3_RXD	4	SP4_RXD
5	SP3_TXD	6	SP4_TXD
7	SP3_DTR	8	SP4_DTR
9	GND	10	GND
11	SP3_DSR	12	SP4_DSR
13	SP3_RTS	14	SP4_RTS
15	SP3_CTS	16	SP4_CTS
17	SP3_RI	18	SP4_RI
19	NC	20	NC
MH1	GND	MH2	GND

CFast Card Slot

Connector type: Standard CFast connector

Connector location: CN6

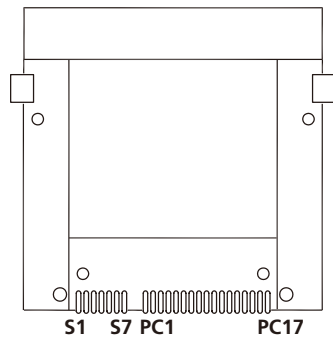

Pin	Definition	Pin	Definition
S1	GND	S2	SATA_TXP0
S3	SATA_TXN0	S4	GND
S5	SATA_RXN0	S6	SATA_RXP0
S7	GND	PC1	CFAST_CDI
PC2	GND	PC3	NC
PC4	NC	PC5	NC
PC6	NC	PC7	GND
PC8	CFAST_ACCESS	PC9	CFAST_ACCESS
PC10	NC	PC11	NC
PC12	NC	PC13	VCC3
PC14	VCC3	PC15	GND
PC16	GND	PC17	CFAST_CDO
MH1	CHASSIS_GND	MH2	CHASSIS_GND

SIM Card Connector

Connector location: IDE1

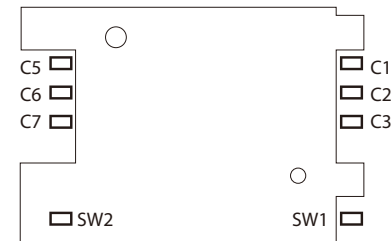

Pin	Definition	Pin	Definition
C1	UIM_PWR	C2	UIM_RESET
C3	UIM_CLK	C5	GND
C6	UIM_VPP	C7	UIM_DATA
SW1	GND	SW2	GND

Audio Connectors

Connector type: 2x 3.5mm TRS

Connector location: CN7A (Mic-in) and CN7B (Line-out)

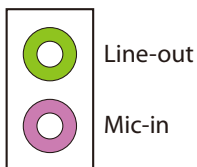

Pin	Definition	Pin	Definition
1	R_CH_GND	2	MIC1_L3
3	MIC_GND	4	MIC_JD
5	MIC1_R3	MH1	R_CH_GND
MH2	R_CH_GND	MH3	R_CH_GND
MH4	R_CH_GND	NH1	NC
22	OUT_L	23	AGND
24	EXLINEOUT_JD	25	OUT_R

LED Indicators

Connector location: LED2A, LED2B, LED2C and LED2D

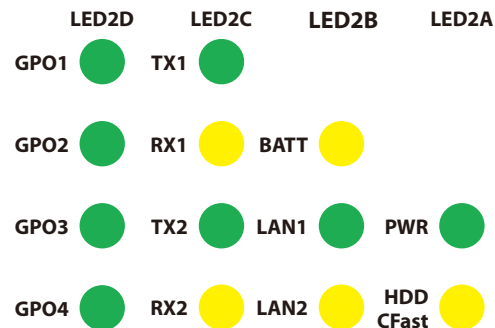

	Pin	Definition	Pin	Definition
LED2A	A1	VCC5	C1	HDD_LED_N
	A2	VCC3	C2	PWR_LED_N
	A3	NC	C3	NC
	A4	NC	C4	NC
LED2B	A1	LAN2_ACT_CON	C1	LAN2_LED_ACT#
	A2	LAN1_ACT_CON	C2	LAN1_LED_ACT#
	A3	BAT_LED_N	C3	GND
	A4	NC	C4	NC
LED2C	A1	COM2_RXLEDP	C1	COM2_RXLEDN
	A2	COM2_TXLEDP	C2	COM2_TXLEDN
	A3	COM1_RXLEDP	C3	COM1_RXLEDN
	A4	COM1_TXLEDP	C4	COM1_TXLEDN
LED2D	A1	VCC5	C1	GPO_PR3
	A2	VCC5	C2	GPO_PR2
	A3	VCC5	C3	GPO_PR1
	A4	VCC5	C4	GPO_PRO

External I/O Interfaces - Rear Panel

9V - 30V DC Power Input

Connector type: Phoenix Contact 1x3 3-pin terminal block

Connector location: CN8

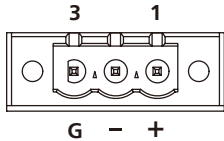

Pin	Definition
1	VIN_VCC
2	VIN_VSS
3	Chassis_GND

Remote Power On/Off Switch

Connector type: 2-pin switch

Connector location: JP11



Pin	Definition
1	PBT_TR
2	GND

DVI-I Connector

Connector type: 24-pin D-Sub, 2.0mm-M-180 (DVI)

Connector location: CON1

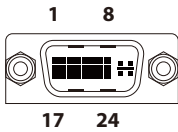

Pin	Definition	Pin	Definition
1	TX2-	2	TX2+
3	GND	4	NC
5	NC	6	DDC_CLK
7	DDC_DATA	8	VSYNC_VGA
9	TX1-	10	TX1+
11	GND	12	NC
13	NC	14	DVI1_PWR (+5V)
15	GND	16	HotPlugDet
17	TX0-	18	TX0+
19	GND	20	DDC_CLK_VGA
21	DDC_DATA_VGA	22	GND
23	TXCLK+	24	TXCLK-
C1	RED	C2	GREEN
C3	BLUE	C4	HSYNC_VGA
C5A	VGADET	C5B	GND
MH1	CHASSIS_GND	MH2	CHASSIS_GND

HDMI

Connector type: HDMI port

Connector location: J4

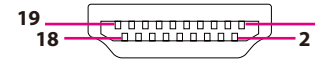

Pin	Definition	Pin	Definition
1	HDMI_DATA2_P_C	2	GND
3	HDMI_DATA2_N_C	4	HDMI_DATA1_P_C
5	GND	6	HDMI_DATA1_N_C
7	HDMI_DATA0_P_C	8	GND
9	HDMI_DATA0_N_C	10	HDMI_CLK_P_C
11	GND	12	HDMI_CLK_N_C
13	NC	14	NC
15	HDMI_CTRL_CLK_C	16	HDMI_CTRL_DAT_C
17	GND	18	HDMI_PWR
19	HDMI_HPD		
MH1	CHASSIS_GND	MH2	CHASSIS_GND
MH3	CHASSIS_GND	MH4	CHASSIS_GND

LAN1 and USB 2.0 Ports

Connector type: RJ45 port with LEDs

Dual USB 2.0 ports, Type A

Connector location: CN5A (USB) and CN5B (LAN)

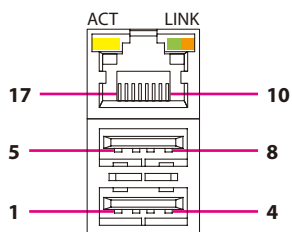

Act	Status
Flashing Yellow	Data activity
Off	No activity

Link	Status
Steady Green	1G network link
Steady Orange	100Mbps network link
Off	10Mbps or no link

Pin	Definition	Pin	Definition
1	VCC	2	DATA1-
3	DATA1+	4	GND
5	VCC	6	DATA-
7	DATA+	8	GND
9	V1P5_LAN	10	LAN1_MDI0P
11	LAN1_MDI0N	12	LAN1_MDI1P
13	LAN1_MDI1N	14	LAN1_MDI2P
15	LAN1_MDI2N	16	LAN1_MDI3P
17	LAN1_MDI3N	18	GND
19	LAN1_LINK1G#	20	LAN1_LINK100#
21	LAN1_LED_ACT#	22	3VSB
MH5	Chassis_GND	MH6	Chassis_GND
MH7	Chassis_GND	MH8	Chassis_GND

LAN2 and USB 2.0 Ports

Connector type: RJ45 port with LEDs

Dual USB 2.0 ports, Type A

Connector location: CN4A (USB) and CN4B (LAN)

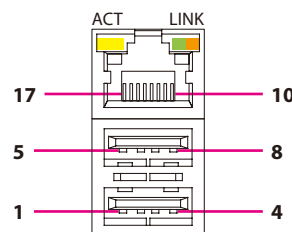

Act	Status
Flashing Yellow	Data activity
Off	No activity

Link	Status
Steady Green	1G network link
Steady Orange	100Mbps network link
Off	10Mbps or no link

Pin	Definition	Pin	Definition
1	VCC	2	DATA1-
3	DATA1+	4	GND
5	VCC	6	DATA-
7	DATA+	8	GND
9	V1P5_LAN2	10	LAN2_MDI0P
11	LAN2_MDI0N	12	LAN2_MDI1P
13	LAN2_MDI1N	14	LAN2_MDI2P
15	LAN2_MDI2N	16	LAN2_MDI3P
17	LAN2_MDI3N	18	GND
19	LAN2_LINK1G#	20	LAN2_LINK100#
21	LAN2_LED_ACT#	22	3VSB
MH5	Chassis_GND	MH6	Chassis_GND
MH7	Chassis_GND	MH8	Chassis_GND

COM 1 (RS232/422/485)

Connector type: DB-9 port, 9-pin D-Sub

Connector location: COM1A

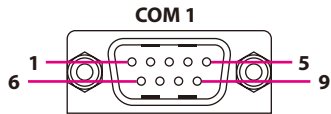

RS232		RS485		RS422	
Pin	Definition	Pin	Definition	Pin	Definition
1	SP1_DCD	1	SP1_DATA-	1	SP1_TX-
2	SP1_RXD	2	SP1_DATA+	2	SP1_TX+
3	SP1_TXD	3	NC	3	SP1_RX+
4	SP1_DTR	4	NC	4	SP1_RX-
5	ISO_GND	5	ISO_GND	5	ISO_GND
6	SP1_DSR	6	NC	6	SP1_RTS-
7	SP1_RTS	7	NC	7	SP1_RTS+
8	SP1_CTS	8	NC	8	SP1_CTS+
9	SP1_RI	9	NC	9	SP1_CTS-

COM 2 (RS232/422/485)

Connector type: DB-9 port, 9-pin D-Sub

Connector location: COM1B

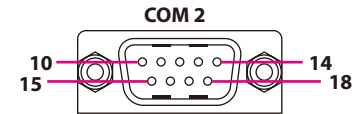

RS232		RS485		RS422	
Pin	Definition	Pin	Definition	Pin	Definition
10	SP2_DCD	10	SP2_DATA-	10	SP2_TX-
11	SP2_RXD	11	SP2_DATA+	11	SP2_TX+
12	SP2_TXD	12	NC	12	SP2_RX+
13	SP2_DTR	13	NC	13	SP2_RX-
14	ISO_GND	14	ISO_GND	14	ISO_GND
15	SP2_DSR	15	NC	15	SP2_RTS-
16	SP2_RTS	16	NC	16	SP2_RTS+
17	SP2_CTS	17	NC	17	SP2_CTS+
18	SP2_RI	18	NC	18	SP2_CTS-

Internal Connectors

BIOS Pin Header

Connector type: 2x3 6-pin Wafer, 2.0mm pitch

Connector location: JFW1

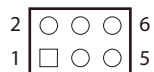

Pin	Definition	Pin	Definition
1	VCC	2	GND
3	CS#0	4	CLK
5	SO	6	SI

SATA Connector

Connector type: Standard Serial ATA 7P (1.27mm, SATA-M-180)

Connector location: SATA1

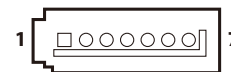

Pin	Definition	Pin	Definition
1	GND	2	SATA_TXP2
3	SATA_TXN2	4	GND
5	SATA_RXN2	6	SATA_RXP2
7	GND		

SATA Power Connector

Connector type: 1x4 4-pin header, 2.0mm pitch

Connector location: J6

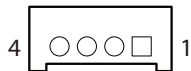

Pin	Definition
1	VCC12
2	GND
3	GND
4	VCC5

Port 80 Connector

Connector type: 1x10 10-pin header, 1.0mm pitch

Connector location: J3



Pin	Definition	Pin	Definition
1	GND	2	PLTRST_3P3#
3	LPC_CLK0_DEBUG	4	LPC_FRAME#
5	LPC_AD3	6	LPC_AD2
7	LPC_AD1	8	LPC_AD0
9	VCC3	10	VCC3
MH1	GND	MH2	GND

GPS Connector

Connector type: 1x6 6-pin header, 1.25mm pitch

Connector location: J1



Pin	Definition	Pin	Definition
1	3VSB	2	NC
3	COM3_TXD	4	COM3_RXD
5	GND	6	VCC3
MH1	GND	MH2	GND

CPU Fan Connector

Connector type: 1x4 4-pin Wafer, 2.54mm pitch

Connector location: CN9



Pin	Definition
1	GND
2	VCC12
3	CPUFANIN
4	CPUFANOUT

RTC Pin Header

Connector type: 1x2 2-pin header, 1.25mm pitch
Connector location: J2

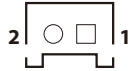

Pin	Definition
1	GND
2	VBAT

LAN1 LED Signal Pin Header

Connector type: 2x2 4-pin header, 2.0mm pitch
Connector location: JP8

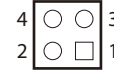

Pin	Definition	Pin	Definition
1	LAN1_ACT_CON	2	LAN1_LED_ACT#
3	LAN1_LINK1G#	4	LAN1_100#_CON

LAN2 LED Signal Pin Header

Connector type: 2x2 4-pin header, 2.0mm pitch

Connector location: JP5

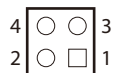

Pin	Definition	Pin	Definition
1	LAN2_ACT_CON	2	LAN2_LED_ACT#
3	LAN2_LINK1G#	4	LAN2_100#_CON

3G Line-out Pin Header

Connector type: 1x3 3-pin header, 2.54mm pitch

Connector location: JP6



Pin	Definition
1	LOUT_L
2	LOUT_R
3	ANGND

3G Mic-in Pin Header

Connector type: 1x3 3-pin header, 2.54mm pitch

Connector location: JP7



Pin	Definition
1	MIC_L
2	MIC_R
3	ANGND

Line-in Pin Header

Connector type: 1x4 4-pin header, 2.0mm pitch

Connector location: JP10



Pin	Definition
1	LIN_L
2	LIN_JD
3	LIN_GND
4	LIN_R

Speaker-out Pin Header

Connector type: 1x5 5-pin header, 2.0mm pitch

Connector location: JP9



Pin	Definition	Pin	Definition
1	FRONT_L+	2	FRONT_L-
3	AGND	4	FRONT_R+
5	FRONT_R-		

PS2 Keyboard/Mouse Pin Header

Connector type: 2x4 8-pin header, 2.54mm pitch

Connector location: JP4

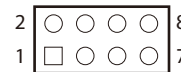

Pin	Definition	Pin	Definition
1	5VSB	2	5VSB
3	KDAT_R	4	MDAT_R
5	KCLK_R	6	MCLK_R
7	GND	8	GND

GPIO Pin Header

Connector type: 2x5 10-pin header, 2.0mm pitch

Connector location: JP2

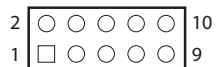

Pin	Definition	Pin	Definition
1	VCC5	2	GND
3	ICH_GPO0_OUT	4	ICH_GPIO_IN
5	ICH_GPO1_OUT	6	ICH_GPI1_IN
7	ICH_GPO2_OUT	8	ICH_GPI2_IN
9	ICH_GPO3_OUT	10	ICH_GPI3_IN

MCU Flash Pin Header

Connector type: 1x4 4-pin header, 2.0mm pitch

Connector location: JP1



Pin	Definition
1	3VSB
2	SBW_TCK
3	SBW_TDIO
4	GND

Reset Button Pin Header

Connector type: 1x2 2-pin header, 2.0mm pitch

Connector location: JP12



Pin	Definition
1	PMC_RSTBTN#
2	GND

PWR_LED/HDD_LED/SMB_BUS/S3/SW_ON/RESET

Connector type: 2x7 14-pin header, 2.0mm pitch

Connector location: JP3

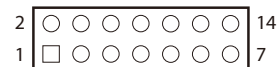

Pin	Definition	Pin	Definition
1	PWR_LED_N	2	POWER_LED_PWR
3	HDD_LED_N	4	HDD_LED_PWR
5	SMB_CLK	6	SMB_DATA
7	3VSB	8	GND
9	SLP_S3#	10	PSON
11	PBT_SW	12	GND
13	PM_RESET#_J	14	GND

12VSB DC-IN

Connector type: 1x6 6-pin header, 2.5mm pitch

Connector location: J5



Pin	Definition	Pin	Definition
1	12VSB	2	12VSB
3	12VSB	4	GND
5	GND	6	GND

Mini-PCIe Connector (3G, Wi-Fi)

Connector location: CN10

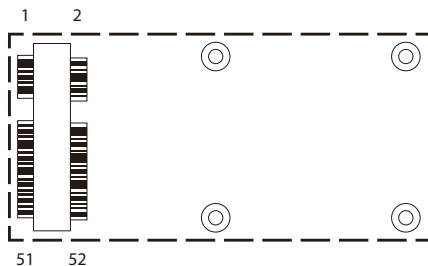

Pin	Definition	Pin	Definition
1	PCIEWAKE#	2	+3VSB
3	N/A	4	GND
5	N/A	6	+1.5V
7	CLKREQ#	8	N/A
9	GND	10	N/A
11	REF CLK-	12	N/A
13	REF CLK+	14	N/A
15	GND	16	N/A
17	N/A	18	GND
19	N/A	20	Disable#
21	GND	22	RST#
23	PCIERX0-	24	+3VSB
25	PCIERX0+	26	GND

Pin	Definition	Pin	Definition
27	GND	28	+1.5V
29	GND	30	SMBCLK
31	PCIETX0-	32	SMBDATA
33	PCIETX0+	34	GND
35	GND	36	USB_D-
37	GND	38	USB_D+
39	+3VSB	40	GND
41	+3VSB	42	N/A
43	GND	44	N/A
45	N/A	46	N/A
47	N/A	48	+1.5V
49	N/A	50	GND
51	N/A	52	+3VSB

Mini-PCIe Connector (mSATA, Wi-Fi)

Connector location: CN3

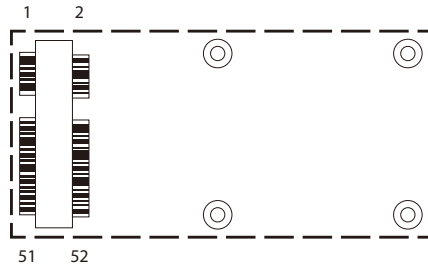

Pin	Definition	Pin	Definition
1	PCIEWAKE#	2	+3VSB
3	N/A	4	GND
5	N/A	6	V1P5S
7	CLKREQ#	8	N/A
9	GND	10	N/A
11	REF CLK-	12	N/A
13	REF CLK+	14	N/A
15	GND	16	N/A
17	N/A	18	GND
19	N/A	20	Disable#
21	GND	22	RST#
23	PCIERX0-	24	+3VSB
25	PCIERX0+	26	GND

Pin	Definition	Pin	Definition
27	GND	28	+1.5V
29	GND	30	SMBCLK
31	PCIETX0-	32	SMBDATA
33	PCIETX0+	34	GND
35	GND	36	USB_D-
37	GND	38	USB_D+
39	+3VSB	40	GND
41	+3VSB	42	N/A
43	N/A	44	N/A
45	N/A	46	N/A
47	N/A	48	+1.5V
49	N/A	50	GND
51	PCIE_mSATA_SEL_51	52	+3VSB

PCIe x4 Slot (Only support PCIe x1 speed & signal)

Connector type: PCIe x4 Slot

Connector location: CN11

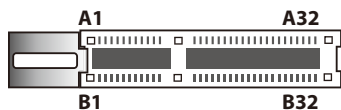

Pin	Definition	Pin	Definition
A1	PRSNT1	B1	VCC12
A2	VCC12	B2	VCC12
A3	VCC12	B3	VCC12
A4	GND	B4	GND
A5	NC	B5	SMB_CLK
A6	NC	B6	SMB_DATA
A7	NC	B7	GND
A8	NC	B8	VCC3
A9	VCC3	B9	NC
A10	VCC3	B10	3VSB
A11	PCIEX4_PLTRST	B11	PCIE_WAKE#
A12	GND	B12	NC
A13	REFCLK+	B13	GND
A14	REFCLK-	B14	HUB_TXP1
A15	GND	B15	HUB_TXN1
A16	HUB_RXP1	B16	GND

Pin	Definition	Pin	Definition
A17	HUB_RXN1	B17	PCIE_PRSNT2
A18	GND	B18	GND
A19	NC	B19	HUB_TXP2
A20	GND	B20	HUB_TXN2
A21	HUB_RXP2	B21	GND
A22	HUB_RXN2	B22	GND
A23	GND	B23	NC
A24	GND	B24	NC
A25	NC	B25	GND
A26	NC	B26	GND
A27	GND	B27	NC
A28	GND	B28	NC
A29	NC	B29	GND
A30	NC	B30	NC
A31	GND	B31	NC
A32	NC	B32	GND

CHAPTER 3: SYSTEM SETUP

Removing the Bottom Cover



Prior to removing the chassis cover, make sure the unit's power is off and disconnected from the power sources to prevent electric shock or system damage.



Note:
Installation for SATA Hard Drive

1. With the bottom side of the chassis facing up, remove the mounting screw on the bottom cover and then put them in a safe place for later use.



2. Lift up the cover and remove it from the chassis.

Removing the Top Cover

1. Remove the mounting screw on the top cover and then put them in a safe place for later use.

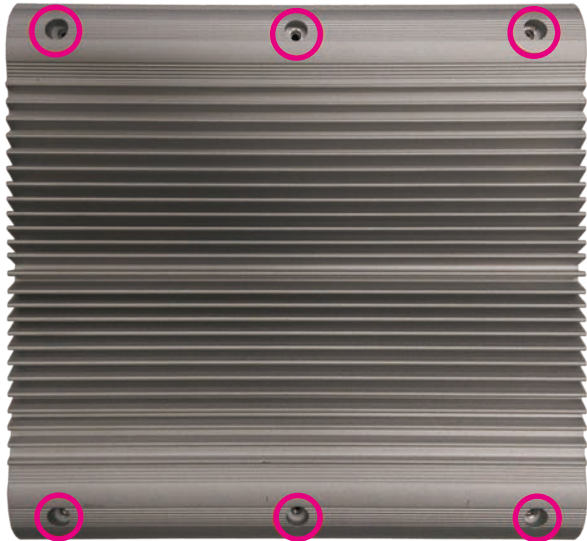

2. Lift up the cover and remove it from the chassis.

Installing a Mini-PCIe Module (Half-size)

1. Locate the mini-PCI Express slot on the board.

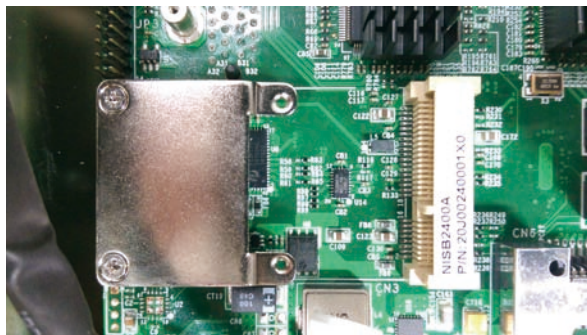

2. Insert the Wi-Fi module into the mini-PCI Express slot at a 45 degree angle until the gold-plated connector on the edge of the module completely disappears inside the slot.



3. Push the module down and then secure it with mounting screws.

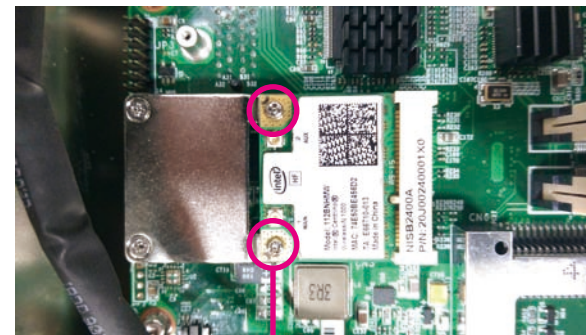

Mounting
screw

Installing a Mini-PCIe Module (Full-size)

1. Locate the mini-PCI Express slot on the board. Remove the LAN module bracket and put it in a safe place.

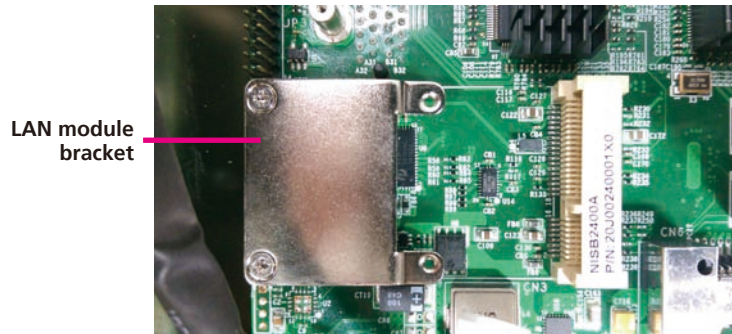

2. Insert the wireless LAN module into the mini-PCI Express slot at a 45 degree angle until the gold-plated connector on the edge of the module completely disappears inside the slot.



3. Push the module down and then secure it with mounting screws.

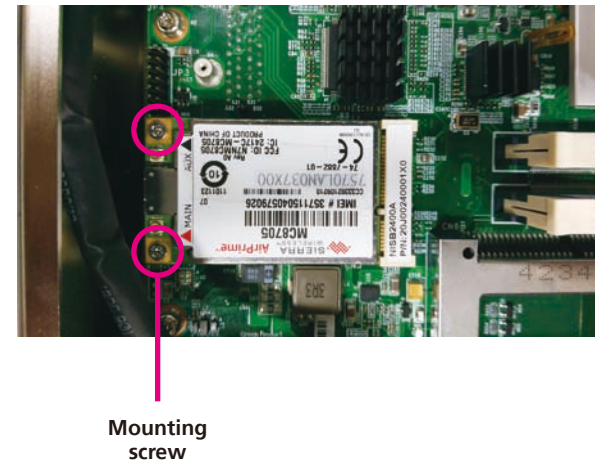

Installing a SO-DIMM Memory Module

1. Locate the SO-DIMM socket.

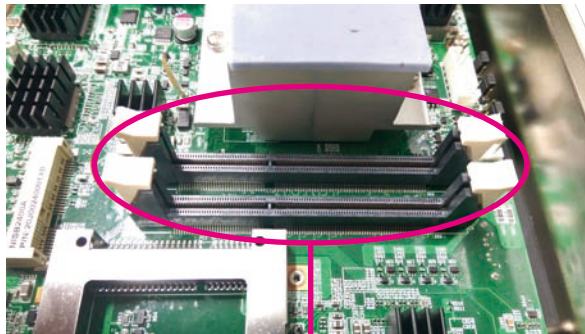

SO-DIMM
sockets

2. Release the lock on the SO-DIMM socket.

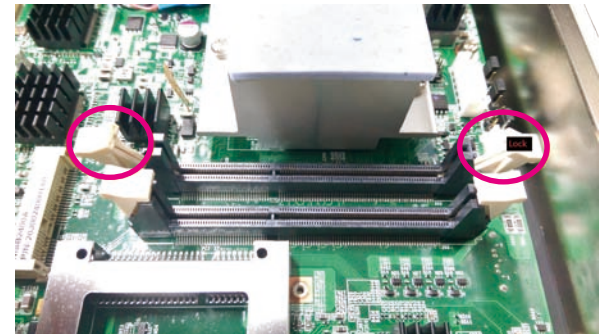

3. Insert the module into the socket at a 90 degree angle. Apply firm and even pressure to each end of the module until it slips into the socket.

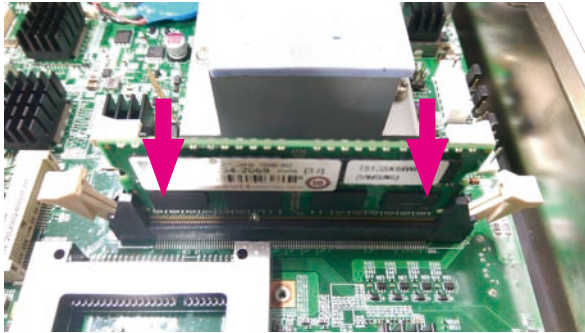

4. While pushing the SO-DIMM into the position, the lock will close automatically.



NOTE: If only one SO-DIMM will be installed, DIMM 1 must be installed first.



Installing a SIM Card

1. Locate the SIM card holder on the front panel and release it by pushing the yellow button.

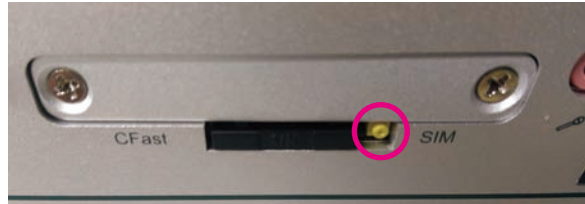

3. Insert the SIM card holder back to its original position.



2. Place the SIM card into the holder.



Installing an Antenna

1. Remove the antenna hole covers located on the front panel.



2. Insert the antenna jack end of the cable through the antenna hole.

3. Insert the 2 rings (ring 1 and ring 2) onto the antenna jack end of the cable.

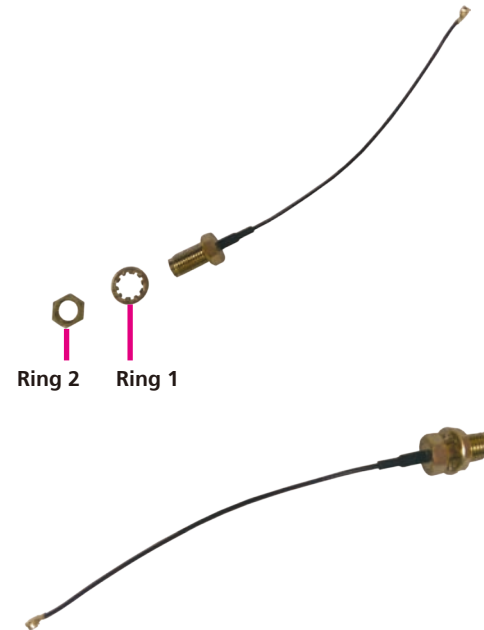

4. Secure the external antenna onto the antenna jack.



5. Attach the other end of the antenna cable onto the module.

Installing a SATA Hard Drive for NISE 2400

1. Remove the bottom cover before installing a SATA HDD.
2. Remove the 4 screws around the empty HDD bracket.

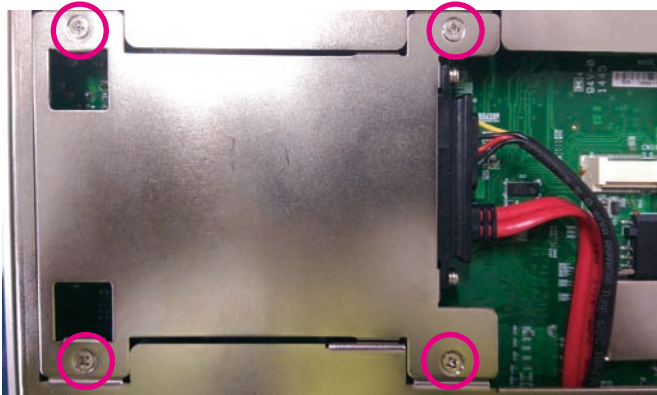

3. Use the screws to secure the 2.5" HDD drive in place.

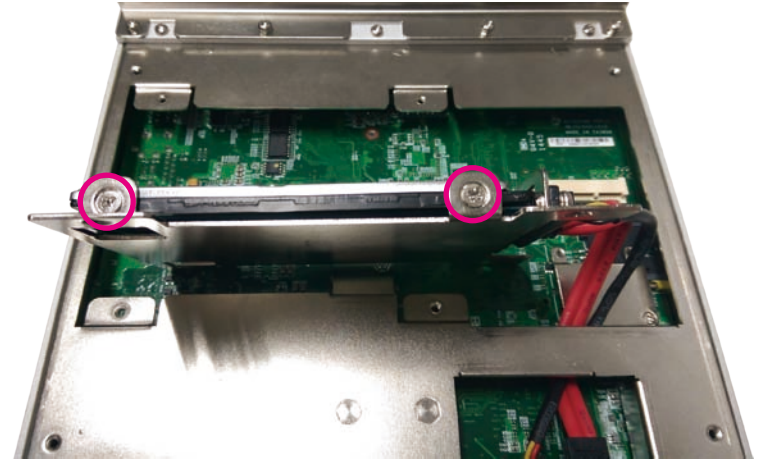

4. Secure the HDD bracket to its original place.



Installing a SATA Hard Drive for NISE 2410 and NISE 2420

1. Remove the bottom cover before installing a SATA HDD.
2. Remove the 4 screws around the empty HDD bracket.

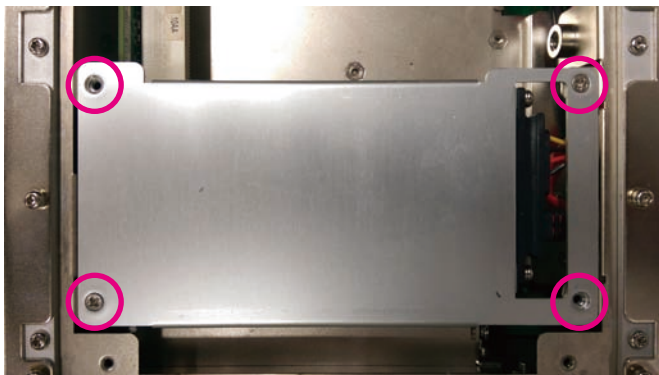

3. Use the screws to secure the 2.5" HDD drive in place.

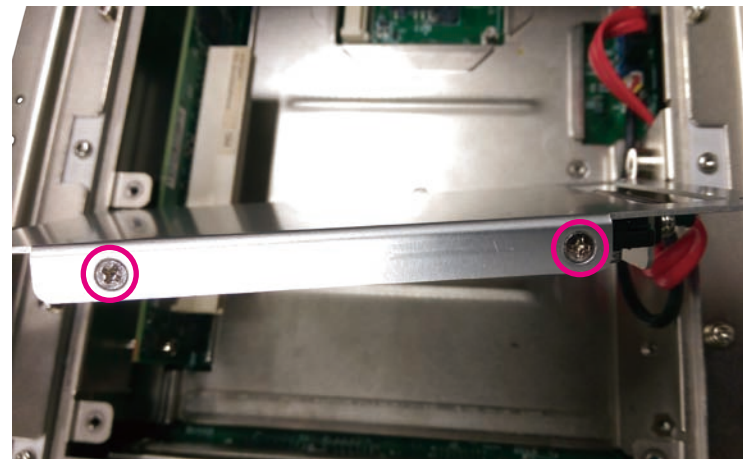

4. Secure the HDD bracket to its original place.

CHAPTER 4: BIOS SETUP

This chapter describes how to use the BIOS setup program for the NISE 2400 series. The BIOS screens provided in this chapter are for reference only and may change if the BIOS is updated in the future.

To check for the latest updates and revisions, visit the NEXCOM website at www.nexcom.com.tw.

About BIOS Setup

The BIOS (Basic Input and Output System) Setup program is a menu driven utility that enables you to make changes to the system configuration and tailor your system to suit your individual work needs. It is a ROM-based configuration utility that displays the system's configuration status and provides you with a tool to set system parameters.

These parameters are stored in non-volatile battery-backed-up CMOS RAM that saves this information even when the power is turned off. When the system is turned back on, the system is configured with the values found in CMOS.

With easy-to-use pull down menus, you can configure such items as:

- Hard drives, diskette drives, and peripherals
- Video display type and display options
- Password protection from unauthorized use
- Power management features

The settings made in the setup program affect how the computer performs. It is important, therefore, first to try to understand all the setup options, and second, to make settings appropriate for the way you use the computer.

When to Configure the BIOS

- This program should be executed under the following conditions:
 - When changing the system configuration
 - When a configuration error is detected by the system and you are prompted to make changes to the setup program
 - When resetting the system clock
 - When redefining the communication ports to prevent any conflicts
 - When making changes to the Power Management configuration
 - When changing the password or making other changes to the security setup

Normally, CMOS setup is needed when the system hardware is not consistent with the information contained in the CMOS RAM, whenever the CMOS RAM has lost power, or the system features need to be changed.

Default Configuration

Most of the configuration settings are either predefined according to the Load Optimal Defaults settings which are stored in the BIOS or are automatically detected and configured without requiring any actions. There are a few settings that you may need to change depending on your system configuration.

Entering Setup











When the system is powered on, the BIOS will enter the Power-On Self Test (POST) routines. These routines perform various diagnostic checks; if an error is encountered, the error will be reported in one of two different ways:

- If the error occurs before the display device is initialized, a series of beeps will be transmitted.
- If the error occurs after the display device is initialized, the screen will display the error message.

Powering on the computer and immediately pressing allows you to enter Setup.

Press the  key to enter Setup:

Legends

Key	Function
	Moves the highlight left or right to select a menu.
	Moves the highlight up or down between sub-menus or fields.
	Exits the BIOS Setup Utility.
	Scrolls forward through the values or options of the highlighted field.
	Scrolls backward through the values or options of the highlighted field.
	Selects a field.
	Displays General Help.
	Load previous values.
	Load optimized default values.
	Saves and exits the Setup program.
	Press <Enter> to enter the highlighted sub-menu

Scroll Bar

When a scroll bar appears to the right of the setup screen, it indicates that there are more available fields not shown on the screen. Use the up and down arrow keys to scroll through all the available fields.

Submenu

When “▶” appears on the left of a particular field, it indicates that a submenu which contains additional options are available for that field. To display the submenu, move the highlight to that field and press  .

BIOS Setup Utility

Once you enter the AMI BIOS Setup Utility, the Main Menu will appear on the screen. The main menu allows you to select from several setup functions and one exit. Use arrow keys to select among the items and press  to accept or enter the submenu.

Main

The Main menu is the first screen that you will see when you enter the BIOS Setup Utility.

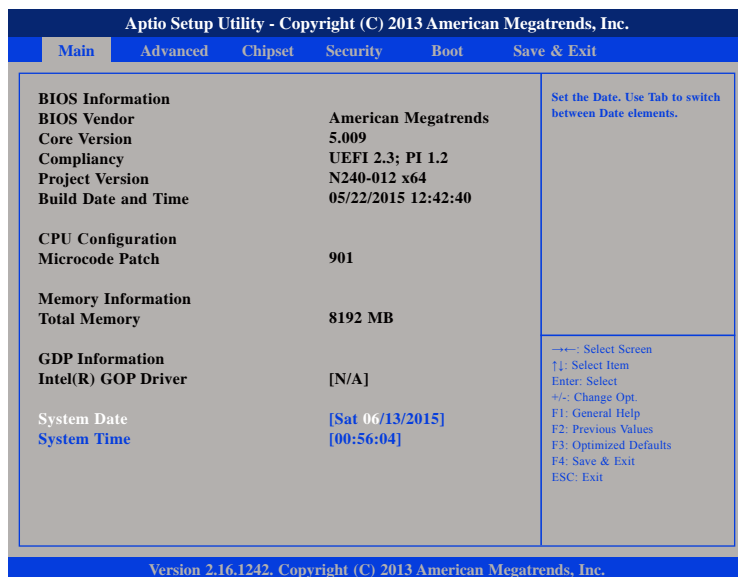

System Date

The date format is <day>, <month>, <date>, <year>. Day displays a day, from Monday to Sunday. Month displays the month, from January to December. Date displays the date, from 1 to 31. Year displays the year, from 1999 to 2099.

System Time

The time format is <hour>, <minute>, <second>. The time is based on the 24-hour military-time clock. For example, 1 p.m. is 13:00:00. Hour displays hours from 00 to 23. Minute displays minutes from 00 to 59. Second displays seconds from 00 to 59.

Advanced

The Advanced menu allows you to configure your system for basic operation. Some entries are defaults required by the system board, while others, if enabled, will improve the performance of your system or let you set some features according to your preference.



Setting incorrect field values may cause the system to malfunction.



ACPI Settings

This section is used to configure ACPI Settings.

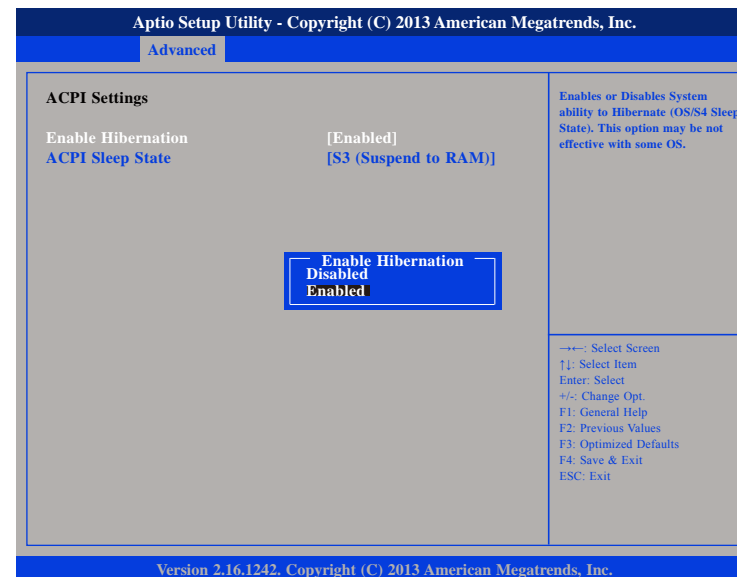

Enable Hibernation

Enables or disables system ability to hibernate (OS/S4 Sleep State). This option may not be effective with some OS.

ACPI Sleep State



Select the highest ACPI sleep state the system will enter when the suspend button is pressed. The options are Suspend Disabled and S3 (Suspend to RAM).

IT8786E Super IO Configuration

This section is used to configure the serial ports.



Super IO Chip

Displays the Super I/O chip used on the board.

Serial Port 1 Configuration

This section is used to configure serial port 1.



Serial Port

Enables or disables the serial port.

Onboard Serial Port Mode

Select this to change the serial port mode to RS232, RS422, RS485 or RS485 Auto.

Serial Port 2 Configuration

This section is used to configure serial port 2.



Serial Port

Enables or disables the serial port.

Onboard Serial Port Mode

Select this to change the serial port mode to RS232, RS422, RS485 or RS485 Auto.

Serial Port 3 Configuration

This section is used to configure serial port 3.



Serial Port

Enables or disables the serial port.

Onboard Serial Port Mode

Select this to change the serial port mode to RS232 or GPS.

Serial Port 4 Configuration

This section is used to configure serial port 4.

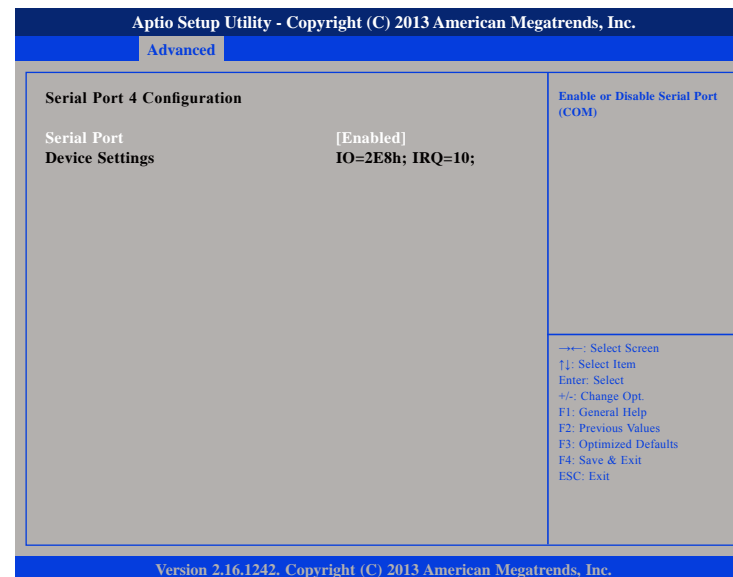

Serial Port

Enables or disables the serial port.

Hardware Monitor

This section is used to monitor hardware status such as temperature, fan speed and voltages.

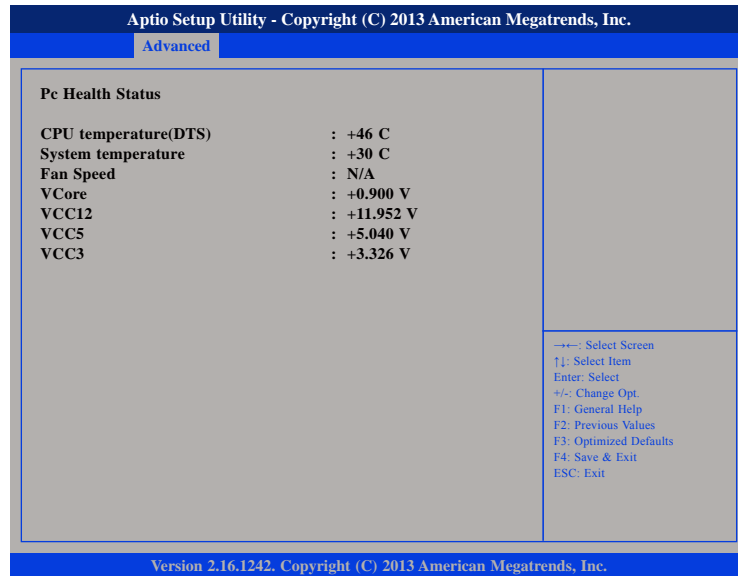

VCore

Detects and displays the Vcore CPU voltage.

VCC12

Detects and displays 12V voltage.

VCC5

Detects and displays 5V voltage.

VCC3

Detects and displays 3.3V voltage.

CPU Temperature (DTS)

Detects and displays the current CPU temperature.

System Temperature

Detects and displays the current system temperature.

Fan Speed

Detects and displays the fan speed.

CPU Configuration

This section is used to configure the CPU.

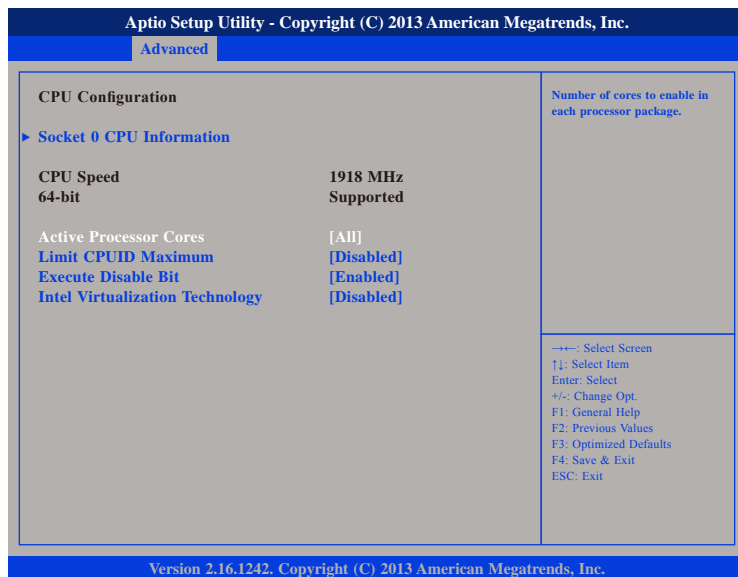

Active Processors Cores

Select the number of cores to enable in each processor package.

Limit CPUID Maximum

The CPUID instruction of some newer CPUs will return a value greater than 3. The default is Disabled because this problem does not exist in the Windows series operating systems. If you are using an operating system other than Windows, this problem may occur. To avoid this problem, enable this field to limit the return value to 3 or lesser than 3.

Execute Disable Bit

When this field is set to Disabled, it will force the XD feature flag to always return to 0. XD can prevent certain classes of malicious buffer overflow attacks when combined with a supporting OS (Windows Server 2003 SP1, Windows XP SP2, SuSE Linux 9.2, RedHat Enterprise 3 Update 3).

Intel® Virtualization Technology

Enables or disables Intel Virtualization technology.

PPM Configuration

This section is used to configure the Processor Power Management (PPM) configuration.



EIST

Enables or disables Intel® SpeedStep.

IDE Configuration

This section is used to configure the SATA drives.



Serial-ATA (SATA)

Enables or disables the SATA controller.

SATA Mode Selection

Configures the SATA as IDE, AHCI or RAID mode.

- IDE This option configures the Serial ATA drives as Parallel ATA physical storage device.
- AHCI This option configures the Serial ATA drives to use AHCI (Advanced Host Controller Interface). AHCI allows the storage driver to enable the advanced Serial ATA features which will increase storage performance.

Serial-ATA Port 0

Enables or disables SATA port 0.

SATA Port0 HotPlug

Enables or disables hot pluggable support on SATA port 0.

Serial-ATA Port 1

Enables or disables SATA port 1.

SATA Port1 HotPlug

Enables or disables hot pluggable support on SATA port 1.

USB Configuration

This section is used to configure the USB.



Legacy USB Support

Enable Enables Legacy USB.

Auto Disables support for Legacy when no USB devices are connected.

Disable Keeps USB devices available only for EFI applications.

USB3.0 Support

Enables or disables USB 3.0 controller support.

XHCI Hand-off and EHCI Hand-off

This is a workaround for OSs that does not support XHCI hand-off and EHCI Hand-off. The XHCI and EHCI ownership change should be claimed by the XHCI and EHCI driver respectively.

Chipset

This section gives you functions to configure the system based on the specific features of the chipset. The chipset manages bus speeds and access to system memory resources.



South Bridge

This field is used to configure South Bridge Parameters.

South Bridge



High Precision Timer

Enables or disables high precision event timer.

Restore AC Power Loss

Select the AC power state when power is re-applied after a power failure.

PCH Azalia Configuration



Azalia

Control detection of the Azalia device.

Disabled Azalia will be unconditionally disabled.
 Enabled Azalia will be unconditionally Enabled.

Azalia HDMI Codec

Enables or disables internal HDMI codec for Azalia.

USB Configuration



USB 2.0(EHCI) Support

Enables or disables the Enhanced Host Controller Interface (USB 2.0), one EHCI controller must always be enabled.

USB RMH Mode

Enables or disables PCH USB rate matching hubs mode.

USB EHCI Debug

Enables or disables PCH EHCI debug capability.

PCI Express Configuration



PCI Express Port 0 to PCI Express Port 3

Enables or disables the PCI Express ports 0 to 3 on the chipset.

Security



Administrator Password

Select this to reconfigure the administrator's password.

User Password

Select this to reconfigure the user's password.

Boot

This section is used to configure the boot features.



Bootup NumLock State

This allows you to determine the default state of the numeric keypad. By default, the system boots up with NumLock on wherein the function of the numeric keypad is the number keys. When set to Off, the function of the numeric keypad is the arrow keys.

Fast Boot

When enabled, the BIOS will shorten or skip some check items during POST. This will decrease the time needed to boot the system.

Network

Controls the execution of UEFI and legacy PXE OpROM.

Onboard LAN PXE

Options to disable onboard LAN PXE ROM or enable it for LAN1 or LAN2 .

Video

Controls the execution of UEFI and legacy video OpROM.

Boot Option Priorities

Adjust the boot sequence of the system. Boot Option #1 is the first boot device that the system will boot from, next will be #2 and so forth.

Save & Exit



Save Changes and Reset

To save the changes and reset, select this field then press <Enter>. A dialog box will appear. Confirm by selecting Yes.

Discard Changes and Reset

To exit the Setup utility without saving the changes, select this field then press <Enter>. You may be prompted to confirm again before exiting.

Restore Defaults

To restore the BIOS to default settings, select this field then press <Enter>. A dialog box will appear. Confirm by selecting Yes.

APPENDIX A: POWER CONSUMPTION

Power Consumption Management

Purpose

The purpose of the power consumption test is to verify the power dissipation of system, and the loading of power supply.

Test Equipment

1. 19" LCD Monitor.
2. DC power supply.
3. Operating System OS: Windows 8 (32 bit)
4. Burn In Test Ver7.1
5. Kpower Software.
6. Network test program.
7. USB 2.0 (5V, 0.5A (Cement Resistor)) *4.
8. USB 3.0 (5V, 1.0A (Cement Resistor)) *1.

Device Under Test

DUT: SYS#1

Test Procedure

1. Make sure mechanical structure and electrical functionality are normal before testing.
2. Install all I/O load devices and according as system input voltage specifications to setup DC Power supply voltage.
3. Measure system maximum power consumption as below mode:
 - Standby mode.
 - BIOS mode.
 - 100% Full loading mode (Include USB load fixture)
4. Measure and record system maximum power consumption value.

Test Configuration

System Configuration	Sys#1
Product	NISE 2400
CPU	Intel ® Atom™ CPU E3827 @ 1.75GHz

Test Result

System Mode		+9Vdc		+12Vdc		+24Vdc		+30Vdc	
		I _{max.}	W _{max}	I _{max.}	W _{max}	I _{max.}	W _{max}	I _{max.}	W _{max}
Intel® Atom™ CPU E3827 @ 1.75GHz /8W. BIOS Version: N240-002 X64	Standby mode. (S3)	0.21A	1.89W	0.21A	2.4W	0.12A	2.88W	0.11A	3.3W
	BIOS mode	1.28A	11.52W	1.0A	12W	0.51A	12.24W	0.43A	12.9W
	100% Full loading mode.	4.04A	36.36W	3.01A	36.12W	1.51A	36.24W	1.21A	36.3W

APPENDIX B: GPIO PROGRAMMING GUIDE

GPIO (General Purpose Input/Output) pins are provided for custom system design. This appendix provides definitions and its default setting for the ten GPIO pins in the NISE 2400 series. The pin definition is shown in the following table:

Pin	GPIO Mode	PowerOn Default	Address	Pin	GPIO Mode	PowerOn Default	Address
1	VCC	-	-	2	GND	-	-
3	GPO0	Low	A03h (Bit6)	4	GPIO	High	A03h (Bit1)
5	GPO1	Low	A02h (Bit5)	6	GPI1	High	A05h (Bit5)
7	GPO2	Low	A07h (Bit0)	8	GPI2	High	A05h (Bit4)
9	GPO3	Low	A07h (Bit1)	10	GPI3	High	A00h (Bit1)

Control the GPO 0/1/2/3 level from I/O port A03h bit6/ A02h bit5 A07h bit0/ A07h bit1.
The bit is Set/Clear indicated output High/Low

GPIO programming sample code

```
#define GPO0      (0x01 << 6)
#define GPO1      (0x01 << 5)
#define GPO2      (0x01 << 0)
#define GPO3      (0x01 << 1)

#define GPO0_HI   outputb(0xA03, GPO0)
#define GPO0_LO   outputb(0xA03, 0x00)
#define GPO1_HI   outputb(0xA02, GPO1)
#define GPO1_LO   outputb(0xA02, 0x00)
#define GPO2_HI   outputb(0xA07, GPO2)
#define GPO2_LO   outputb(0xA07, 0x00)
#define GPO3_HI   outputb(0xA07, GPO3)
#define GPO3_LO   outputb(0xA07, 0x00)

void main(void)
{
    GPO0_HI;
    GPO1_LO;
    GPO2_HI;
    GPO3_LO;
}
```

APPENDIX C: LED PROGRAMMING GUIDE

LEDs are provided for custom system design. This appendix provides definitions and its default setting for the LEDs in the NISE 2400 series.

The LED definition is shown in the following table:

Pin	PowerOn Default	Address
LED2D-PR0	High	A07h (Bit5)
LED2D-PR1	High	A07h (Bit4)
LED2D-PR2	High	A07h (Bit3)
LED2D-PR3	High	A07h (Bit2)

Control the LED2D (PR0/ PR1/ PR2/ PR3) level from I/O port A07h bit (2/3/4/5). The bit is Set/Clear indicated output High/Low

APPENDIX D: WATCHDOG TIMER SETTING

ITE8786 Watchdog Programming Guide

```
#define SUPERIO_PORT    0x2E
#define WDT_SET        0x72
#define WDT_VALUE 0x73

void main(void)
{
    # Enter SuperIO Configuration
    outputb(SUPERIO_PORT, 0x87);
    outputb(SUPERIO_PORT, 0x01);
    outputb(SUPERIO_PORT, 0x55);
    outputb(SUPERIO_PORT, 0x55);

    # Set LDN
    outputb(SUPERIO_PORT, 0x07);
    outputb(SUPERIO_PORT+1 ,0x07);

    # Set WDT setting
    outputb(SUPERIO_PORT, WDT_SET);
    outputb(SUPERIO_PORT+1, 0x90);           # Use the second
                                           # Use the minute, change value to 0x10

    # Set WDT sec/min
    outputb(SUPERIO_PORT, WDT_VALUE);
    outputb(SUPERIO_PORT+1, 0x05); #Set 5 seconds
}
```