



**NEXCOM International Co., Ltd.**

# **Intelligent Platform & Services Business Unit**

## **Edge Computing System**

### **Neu-X300-F65 Series**

#### User Manual

# PREFACE

## Copyright

This publication, including all photographs, illustrations and software, is protected under international copyright laws, with all rights reserved. No part of this manual may be reproduced, copied, translated or transmitted in any form or by any means without the prior written consent from NEXCOM International Co., Ltd.

## Disclaimer

The information in this document is subject to change without prior notice and does not represent commitment from NEXCOM International Co., Ltd. However, users may update their knowledge of any product in use by constantly checking its manual posted on our website: <http://www.nexcom.com>. NEXCOM shall not be liable for direct, indirect, special, incidental, or consequential damages arising out of the use of any product, nor for any infringements upon the rights of third parties, which may result from such use. Any implied warranties of merchantability or fitness for any particular purpose is also disclaimed.

## Acknowledgements

Neu-X300-F65 is a trademark of NEXCOM International Co., Ltd. All other product names mentioned herein are registered trademarks of their respective owners.

## Regulatory Compliance Statements

This section provides the FCC compliance statement for Class A devices and describes how to keep the system CE compliant.

## Declaration of Conformity

### FCC

This equipment has been tested and verified to comply with the limits for a Class A digital device, pursuant to Part 15 of FCC Rules. These limits are designed to provide reasonable protection against harmful interference when the equipment is operated in a commercial environment. This equipment generates, uses, and can radiate radio frequency energy and, if not installed and used in accordance with the instructions, may cause harmful interference to radio communications. Operation of this equipment in a residential area (domestic environment) is likely to cause harmful interference, in which case the user will be required to correct the interference (take adequate measures) at their own expense.

### CE

The product(s) described in this manual complies with all applicable European Union (CE) directives if it has a CE marking. For computer systems to remain CE compliant, only CE-compliant parts may be used. Maintaining CE compliance also requires proper cable and cabling techniques.

## RoHS Compliance



### **NEXCOM RoHS Environmental Policy and Status Update**

NEXCOM is a global citizen for building the digital infrastructure. We are committed to providing green products and services, which are compliant with European Union RoHS (Restriction on Use of Hazardous Substance in Electronic Equipment) directive 2011/65/EU, to be your trusted green partner and to protect our environment.

RoHS restricts the use of Lead (Pb) < 0.1% or 1,000ppm, Mercury (Hg) < 0.1% or 1,000ppm, Cadmium (Cd) < 0.01% or 100ppm, Hexavalent Chromium (Cr6+) < 0.1% or 1,000ppm, Polybrominated biphenyls (PBB) < 0.1% or 1,000ppm, and Polybrominated diphenyl Ethers (PBDE) < 0.1% or 1,000ppm.

In order to meet the RoHS compliant directives, NEXCOM has established an engineering and manufacturing task force to implement the introduction of green products. The task force will ensure that we follow the standard NEXCOM development procedure and that all the new RoHS components and new manufacturing processes maintain the highest industry quality levels for which NEXCOM are renowned.

The model selection criteria will be based on market demand. Vendors and suppliers will ensure that all designed components will be RoHS compliant.

### **How to recognize NEXCOM RoHS Products?**

For existing products where there are non-RoHS and RoHS versions, the suffix "(LF)" will be added to the compliant product name.

All new product models launched after January 2013 will be RoHS compliant. They will use the usual NEXCOM naming convention.

## Warranty and RMA

### NEXCOM Warranty Period

NEXCOM manufactures products that are new or equivalent to new in accordance with industry standard. NEXCOM warrants that products will be free from defect in material and workmanship for 2 years, beginning on the date of invoice by NEXCOM.

### NEXCOM Return Merchandise Authorization (RMA)

- Customers shall enclose the “NEXCOM RMA Service Form” with the returned packages.
- Customers must collect all the information about the problems encountered and note anything abnormal or, print out any on-screen messages, and describe the problems on the “NEXCOM RMA Service Form” for the RMA number apply process.
- Customers can send back the faulty products with or without accessories (manuals, cable, etc.) and any components from the card, such as CPU and RAM. If the components were suspected as part of the problems, please note clearly which components are included. Otherwise, NEXCOM is not responsible for the devices/parts.
- Customers are responsible for the safe packaging of defective products, making sure it is durable enough to be resistant against further damage and deterioration during transportation. In case of damages occurred during transportation, the repair is treated as “Out of Warranty.”
- Any products returned by NEXCOM to other locations besides the customers’ site will bear an extra charge and will be billed to the customer.

### Repair Service Charges for Out-of-Warranty Products

NEXCOM will charge for out-of-warranty products in two categories, one is basic diagnostic fee and another is component (product) fee.

#### System Level

- Component fee: NEXCOM will only charge for main components such as SMD chip, BGA chip, etc. Passive components will be repaired for free, ex: resistor, capacitor.
- Items will be replaced with NEXCOM products if the original one cannot be repaired. Ex: motherboard, power supply, etc.
- Replace with 3rd party products if needed.
- If RMA goods can not be repaired, NEXCOM will return it to the customer without any charge.

#### Board Level

- Component fee: NEXCOM will only charge for main components, such as SMD chip, BGA chip, etc. Passive components will be repaired for free, ex: resistors, capacitors.
- If RMA goods can not be repaired, NEXCOM will return it to the customer without any charge.

## Warnings

Read and adhere to all warnings, cautions, and notices in this guide and the documentation supplied with the chassis, power supply, and accessory modules. If the instructions for the chassis and power supply are inconsistent with these instructions or the instructions for accessory modules, contact the supplier to find out how you can ensure that your computer meets safety and regulatory requirements.

## Cautions

Electrostatic discharge (ESD) can damage system components. Do the described procedures only at an ESD workstation. If no such station is available, you can provide some ESD protection by wearing an antistatic wrist strap and attaching it to a metal part of the computer chassis.

## Safety Information

Before installing and using the device, note the following precautions:

- Read all instructions carefully.
- Do not place the unit on an unstable surface, cart, or stand.
- Follow all warnings and cautions in this manual.
- When replacing parts, ensure that your service technician uses parts specified by the manufacturer.
- Avoid using the system near water, in direct sunlight, or near a heating device.
- The load of the system unit does not solely rely for support from the rackmounts located on the sides. Firm support from the bottom is highly necessary in order to provide balance stability.
- The computer is provided with a battery-powered real-time clock circuit. There is a danger of explosion if battery is incorrectly replaced. Replace only with the same or equivalent type recommended by the manufacturer. Discard used batteries according to the manufacturer's instructions.

## Installation Recommendations

Ensure you have a stable, clean working environment. Dust and dirt can get into components and cause a malfunction. Use containers to keep small components separated.

Adequate lighting and proper tools can prevent you from accidentally damaging the internal components. Most of the procedures that follow require only a few simple tools, including the following:

- A Philips screwdriver
- A flat-tipped screwdriver
- A grounding strap
- An anti-static pad

Using your fingers can disconnect most of the connections. It is recommended that you do not use needle-nose pliers to disconnect connections as these can damage the soft metal or plastic parts of the connectors.

## Safety Precautions

1. Read these safety instructions carefully.
2. Keep this User Manual for later reference.
3. Disconnect this equipment from any AC outlet before cleaning. Use a damp cloth. Do not use liquid or spray detergents for cleaning.
4. For plug-in equipment, the power outlet socket must be located near the equipment and must be easily accessible.
5. Keep this equipment away from humidity.
6. Put this equipment on a stable surface during installation. Dropping it or letting it fall may cause damage.
7. The openings on the enclosure are for air convection to protect the equipment from overheating. DO NOT COVER THE OPENINGS.
8. Make sure the voltage of the power source is correct before connecting the equipment to the power outlet.
9. Place the power cord in a way so that people will not step on it. Do not place anything on top of the power cord. Use a power cord that has been approved for use with the product and that it matches the voltage and current marked on the product's electrical range label. The voltage and current rating of the cord must be greater than the voltage and current rating marked on the product.
10. All cautions and warnings on the equipment should be noted.
11. If the equipment is not used for a long time, disconnect it from the power source to avoid damage by transient overvoltage.
12. Never pour any liquid into an opening. This may cause fire or electrical shock.
13. Never open the equipment. For safety reasons, the equipment should be opened only by qualified service personnel.
14. If one of the following situations arises, get the equipment checked by service personnel:
  - a. The power cord or plug is damaged.
  - b. Liquid has penetrated into the equipment.
  - c. The equipment has been exposed to moisture.
  - d. The equipment does not work well, or you cannot get it to work according to the user's manual.
  - e. The equipment has been dropped and damaged.
  - f. The equipment has obvious signs of breakage.
15. Do not place heavy objects on the equipment.
16. The unit uses a three-wire ground cable which is equipped with a third pin to ground the unit and prevent electric shock. Do not defeat the purpose of this pin. If your outlet does not support this kind of plug, contact your electrician to replace your obsolete outlet.
17. **CAUTION:** DANGER OF EXPLOSION IF BATTERY IS INCORRECTLY REPLACED. REPLACE ONLY WITH THE SAME OR EQUIVALENT TYPE RECOMMENDED BY THE MANUFACTURER. DISCARD USED BATTERIES ACCORDING TO THE MANUFACTURER'S INSTRUCTIONS.
18. Ensure to connect the power cord of the power adapter to a socket-outlet with earthing connection.
19. This product is intended to be supplied by a Listed Power Adapter or DC power source, rated 12Vdc, minimum 8A, minimum T ma=45 degree C, minimum altitude of operation=2000m, and evaluated in accordance to UL/IEC 60950-1 and/or UL/IEC 62368-1. If further assistance is needed, please contact NEXCOM International Co., Ltd. (UL file owner or brand owner) for further information.

## Technical Support and Assistance

1. For the most updated information of NEXCOM products, visit NEXCOM's website at [www.nexcom.com](http://www.nexcom.com).
2. For technical issues that require contacting our technical support team or sales representative, please have the following information ready before calling:
  - Product name and serial number
  - Detailed information of the peripheral devices
  - Detailed information of the installed software (operating system, version, application software, etc.)
  - A complete description of the problem
  - The exact wordings of the error messages

### Warning!

1. Handling the unit: carry the unit with both hands and handle it with care.
2. Maintenance: to keep the unit clean, use only approved cleaning products or clean with a dry cloth.

## Conventions Used in this Manual



### Warning:

Information about certain situations, which if not observed, can cause personal injury. This will prevent injury to yourself when performing a task.



### Caution:

Information to avoid damaging components or losing data.



### Note:

Provides additional information to complete a task easily.



## Global Service Contact Information

### Headquarters

#### **NEXCOM International Co., Ltd.**

9F, No. 920, Zhongzheng Rd.,  
Zhonghe District, New Taipei City, 23586,  
Taiwan, R.O.C.  
Tel: +886-2-8226-7786  
Fax: +886-2-8226-7782  
www.nexcom.com

### Asia

#### **Taiwan**

#### **NexAIoT Headquarters**

#### **Industry 4.0 and Cloud Services**

13F, No.922, Zhongzheng Rd.,  
Zhonghe District, New Taipei City,  
23586, Taiwan, R.O.C.  
Tel: +886-2-8226-7796  
Fax: +886-2-8226-7926  
Email: jacobhuang@nexaiot.com  
www.nexaiot.com

#### **NexAIoT Co., Ltd.**

#### **Taichung Office**

16F, No.250, Sec.2, Chongde Rd.,  
Beitun District,  
Taichung City, 406, Taiwan, R.O.C.  
Tel: +886-4-2249-1179  
Fax: +886-4-2249-1172  
Email: jacobhuang@nexaiot.com  
www.nexaiot.com

#### **NexCOBOT Taiwan Co., Ltd.**

13F, No.916, Zhongzheng Rd.,  
Zhonghe District,  
New Taipei City, 23586, Taiwan, R.O.C.  
Tel: +886-2-8226-7786  
Fax: +886-2-8226-7926  
Email: jennyshern@nexcobot.com  
www.nexcobot.com

#### **GreenBase Technology Corp.**

13F, No.922, Zhongzheng Rd.,  
Zhonghe District,  
New Taipei City, 23586, Taiwan, R.O.C.  
Tel: +886-2-8226-7786  
Fax: +886-2-8226-7900  
Email: vivianlin@nexcom.com.tw  
www.nexcom.com.tw

#### **DivioTec Inc.**

19F-1A, No.97, Sec.4, ChongXin Rd.,  
Sanhong District,  
New Taipei City, 24161, Taiwan, R.O.C.  
Tel: +886-2-8976-3077  
Email: sales@diviotec.com  
www.diviotec.com

#### **AIoT Cloud Corp.**

13F, No.922, Zhongzheng Rd.,  
Zhonghe District,  
New Taipei City, 23586, Taiwan, R.O.C.  
Tel: +886-2-8226-7786  
Fax: +886-2-8226-7782  
Email: alantsai@aiotcloud.net  
www.aiotcloud.dev

#### **EMBUX TECHNOLOGY CO., LTD.**

13F, No.916, Zhongzheng Rd.,  
Zhonghe District,  
New Taipei City, 23586, Taiwan, R.O.C.  
Tel: +886-2-8226-7786  
Fax: +886-2-8226-7782  
Email: info@embux.com  
www.embux.com

#### **TMR TECHNOLOGIES CO., LTD.**

13F, No.916, Zhongzheng Rd.,  
Zhonghe District,  
New Taipei City, 23586, Taiwan, R.O.C.  
Tel: +886-2-8226-7786  
Fax: +886-2-8226-7782  
Email: services@tmrtek.com  
www.tmrtek.com

## China NEXSEC Incorporated

201, Floor 2, Unit 2, Building 15, Yard 3,  
Gaolizhang Road, Haidian District,  
Beijing, 100094, China  
Tel: +86-10-5704-2680  
Fax: +86-10-5704-2681  
Email: marketing@nexsec.cn  
www.nexsec.cn

## NEXCOM Shanghai

Room 406-407, Building C, No 154, Lane 953,  
Jianchuan Road, Minhang District,  
Shanghai, 201108, China  
Tel: +86-21-5278-5868  
Fax: +86-21-3251-6358  
Email: sales@nexcom.cn  
www.nexcom.cn

## NEXCOM Surveillance Technology Corp.

Floor 8, Building B3, Xiufeng Industrial Zone,  
GanKeng Community, Buji Street,  
LongGang District,  
ShenZhen, 518112, China  
Tel: +86-755-8364-7768  
Fax: +86-755-8364-7738  
Email: steveyang@nexcom.com.tw  
www.nexcom.cn

## NEXGOL Chongqing

1st Building No.999,  
Star Boulevard, Yongchuan Dist,  
Chongqing City, 402160, China  
Tel: +86-23-4960-9080  
Fax: +86-23-4966-5855  
Email: sales@nexgol.com.cn  
www.nexcom.cn

## Beijing NexGemo Technology Co.,Ltd.

Room 205, No.1, Fazhan Rd.,  
Beijing International Information Industry Base,  
Changping District,  
Beijing, 102206, China  
Tel: +86-10-8072-2025  
Fax: +86-10-8072-2022  
Email: sales@nexgemo.cn  
www.nexgemo.com

## Japan

### NEXCOM Japan

9F, Tamachi Hara Bldg.,  
4-11-5, Shiba Minato-ku,  
Tokyo, 108-0014, Japan  
Tel: +81-3-5419-7830  
Fax: +81-3-5419-7832  
Email: sales@nexcom-jp.com  
www.nexcom-jp.com

## America

### USA NEXCOM USA

46665 Fremont Blvd.,  
Fremont CA 94538, USA  
Tel: +1-510-656-2248  
Fax: +1-510-656-2158  
Email: sales@nexcom.com  
www.nexcomusa.com

## Europe

### United Kingdom NEXCOM EUROPE

10 Vincent Avenue,  
Crownhill Business Centre,  
Milton Keynes, Buckinghamshire  
MK8 0AB, United Kingdom  
Tel: +44-1908-267121  
Fax: +44-1908-262042  
Email: sales.uk@nexcom.eu  
www.nexcom.com

## Package Contents

Before continuing, verify that the Neu-X300-F65 package that you received is complete. Your package should have all the items listed in the following table.

Item	Name	Qty
1	Neu-X300 System	1
2	Power Adapter	1

### Optional Accessories

Item	Part Number	Name	Description
1	5060200638X00	Thermal Pad	Thermal Pad for Neu-X300-Q370-F65 Ver:A S.W
2	7400120025X00	Power Adapter	Power Adapter FSP:FSP120-AHAN3

## Ordering Information

The following below provides ordering information for Neu-X300-F65.

### **Neu-X300-Q370-F65 (P/N: 10W10X30004X4)**

8th generation Intel® Core™ processor slim and fanless system with PCH Q370

# CONTENTS

## Preface

Copyright .....	iv
Disclaimer .....	iv
Acknowledgements .....	iv
Regulatory Compliance Statements .....	iv
Declaration of Conformity .....	iv
RoHS Compliance .....	v
Warranty and RMA .....	vi
Safety Information .....	viii
Installation Recommendations .....	viii
Safety Precautions .....	ix
Technical Support and Assistance .....	x
Conventions Used in this Manual .....	x
Global Service Contact Information .....	xi
Package Contents .....	xiii
Ordering Information .....	xiv

## Chapter 1: Product Introduction

Neu-X300-F65 Series .....	1
Overview .....	1
Key Features .....	1
Hardware Specifications .....	2
Physical Features .....	4
Neu-X300-F65 Front Panel .....	4
Neu-X300-F65 Rear Panel .....	4
Neu-X300-F65 .....	5

Block Diagram .....	6
---------------------	---

## Chapter 2: Jumpers and Connectors

Before You Begin .....	7
Precautions .....	7
Jumper Settings .....	8
Locations of the Jumpers and Connectors for the Neu-X300 Series .....	9
Top View .....	9
Bottom View .....	10
Jumpers & DIP Switches .....	11
AT/ATX Mode Select .....	11
Clear CMOS .....	11
LVDS Panel Voltage Select .....	12
Backlight Control Voltage Select (Dimming) .....	12
ME Flash Descriptor Security Override .....	13
LVDS Resolution Select .....	14
Connector Pin Definitions .....	15
External I/O Interfaces .....	15
LAN1 and LAN2 Port .....	15
HDMI1, HDMI2 and HDMI3 Port (HDMI3 Only for Q370) .....	15
USB 3.0 Ports .....	16
DC Power Input (+12V Only) .....	16
Internal Connectors .....	17
LVDS Inverter Connector .....	17
System Reset Header .....	17
LED Connector .....	18



- Line-out Connector ..... 18
- Mic-in Connector ..... 19
- System Power Button Header ..... 19
- FAN Connectors ..... 20
- Debug Port/LPC Bus Connector ..... 20
- COM Port Connectors ..... 21
- Battery Connector ..... 21
- LVDS Panel Connector ..... 22
- Internal USB 2.0 Connectors ..... 22
- USB Touch ..... 23
- ATX 4-pin Connector ..... 23
- SATA Connector ..... 24
- SATA Power Connector ..... 24
- System Power Button Connector ..... 25
- GPIO Connector ..... 25
- PCIe Slot Setting ..... 26
- M.2 Connector (M-Key) ..... 27
- M.2 Connector (E-Key) ..... 28
- PCIe x16 Slot ..... 29

- When to Configure the BIOS ..... 42
- Default Configuration ..... 43
- Entering Setup ..... 43
- Legends ..... 43
- BIOS Setup Utility ..... 45
  - Main ..... 45
  - Advanced ..... 46
  - Chipset ..... 55
  - Security ..... 58
  - Boot ..... 60
  - Save & Exit ..... 60

### Chapter 3: System Setup

- Removing the Bottom Cover from the Chassis ..... 31
- Installing an M.2 M-Key SSD Module (M-Key 2280) ..... 32
- Installing a SO-DIMM Memory Module ..... 34
- Installing a Wi-Fi Module (M.2 E-Key Slot) ..... 35
- Installing a CPU ..... 38
- Wall Mounting Instructions ..... 41

### Chapter 4: BIOS Setup

- About BIOS Setup ..... 42

# CHAPTER 1: PRODUCT INTRODUCTION

## Neu-X300-F65 Series

### Overview



Front Panel



Rear Panel

### Key Features

- 8/9th generation Intel® Core™ socket type processor
- 3x HDMI 2.0 resolution 4K@60Hz
- Storage M.2 M Key 2280
- Support iAMT technology
- Dual DDR4 SO-DIMM up to 32G
- Onboard TPM 2.0 IC
- Fan box design

# Hardware Specifications

## CPU Support

- Socket LGA 1151, 8/9th generation Intel® Core™ i3/i5/i7/i9 processor
  - i3-8300 quad core, 3.70 GHz, TDP 65W
  - i5-8500 6 core, 3.00 GHz, TDP 65W
  - i7-8700 6 core, 3.20 GHz, TDP 65W
  - i3-8100T quad core, 3.10 GHz, TDP 35W
  - i5-8500T 6 core, 2.10 GHz, TDP 35W
  - i7-8700T 6 core, 2.40 GHz, TDP 35W
  - i3-9100TE quad core, 2.20 GHz, TDP 35W
  - i5-9500TE 6 core, 2.20 GHz, TDP 35W
  - i7-9700TE 8core, 1.80 GHz, TDP 35W
  - i9-9900T 8 core, 2.10GHz, TDP 35W

## Chipset

- Intel® PCH Q370

## Graphics

- Intel® UHD Graphics 630

## Main Memory

- 2 x 260-pin SO-DIMM sockets, support up to DDR4 2400/2666MHz, non ECC, un-buffered memory up to 32G (single 16G)

## I/O Interface-Front

- 1 x Storage active LED
- 1 x Power LED
- 1 x Power button
- 1 x COM port (support RS232/422/485)
- 2 x COM port (RS232)
- 6 x USB 2.0

## I/O Interface-Rear

- 2 x Antenna holes
- 4 x USB 3.0
- 3 x HDMI 2.0, resolution up to 4096 x 2160 @60Hz
- 2 x RJ45 with LEDs for Gigabit LAN
- 1 x 12V DC input, 4-pin DC jack
- 1 x Line-out

## Internal I/O

- 4 x USB 2.0 pin header
- 1 x PCIe x16 slot
- 1 x SATA connector
- 8 Channel GPIO via pin header

## Expansion

- 1 x M.2 E Key 2230 connector, supports Wi-Fi module

## Storage

- 1 x M.2 M Key 2280 SSD with SATA/PCIe x4 signal
- 1 x Onboard TPM 2.0

## Power Supply

- 1 x External 120W AC/DC power adapter with lock
- Input: 100VAC to 240VAC
- Output: DC+12VDC

## Environment

- Operating temperature: -5°C to 45°C
- Storage temperature: -20°C to 80°C
- Humidity: 95% (non-condensing)



- Shock protection: 50G peak acceleration, 11 ms according to IEC60068-2-27
- Vibration protection:
  - Random: 2Grms @ 5~500 Hz, IEC60068-2-64
  - Sinusoidal: 2G @ 5~500 Hz, IEC60068-2-6

### **Certification**

- CE (EMC EN55032 + EN55035)
- FCC Class A (EMI Part 15B)

### **Dimensions**

- 190mm (L) x 220mm (W) x 53mm (H)

### **Operating System**

- Windows 10 64-bit/Linux

# Physical Features

## Neu-X300-F65 Front Panel

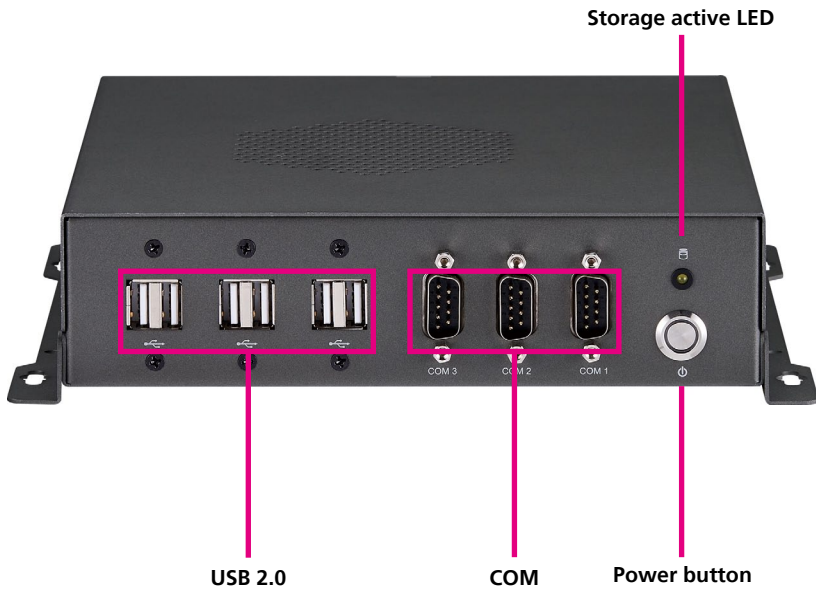

## Neu-X300-F65 Rear Panel

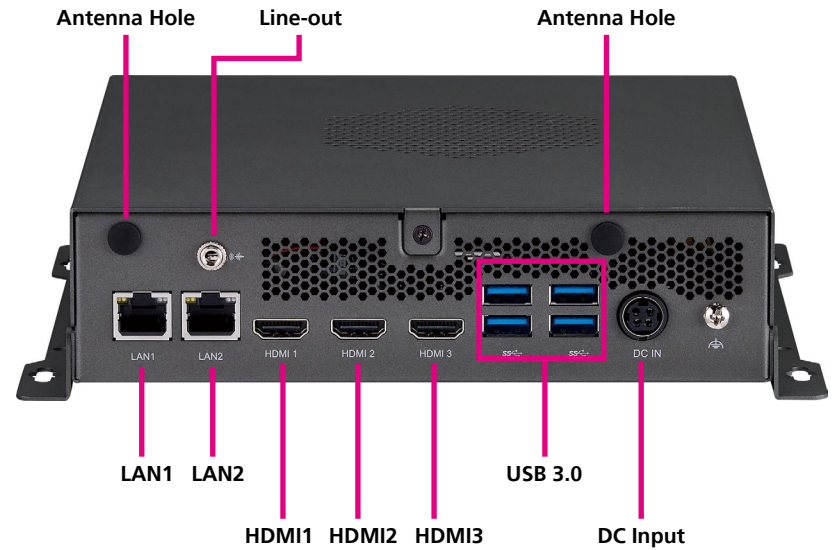

# Neu-X300-F65

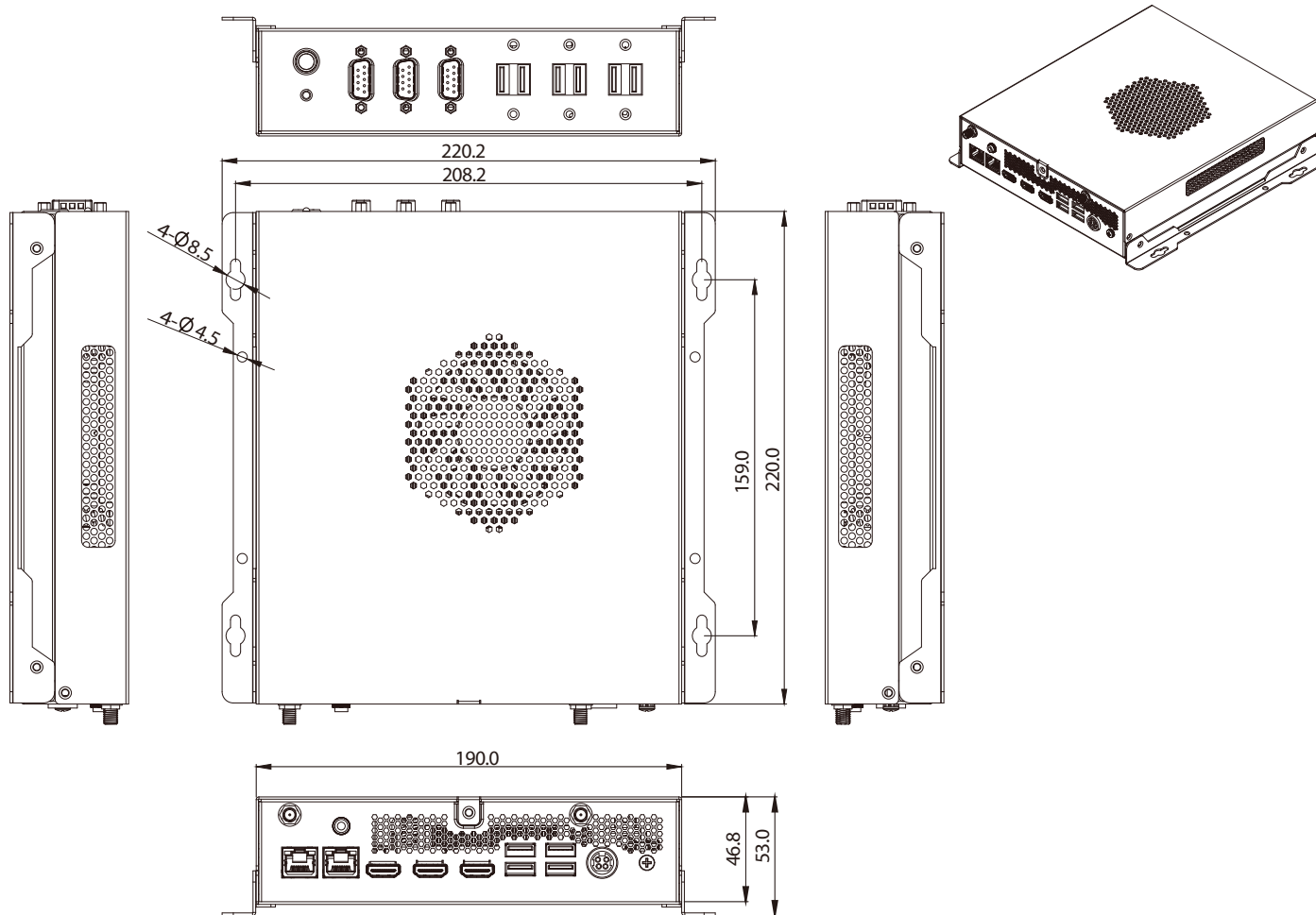

# Block Diagram

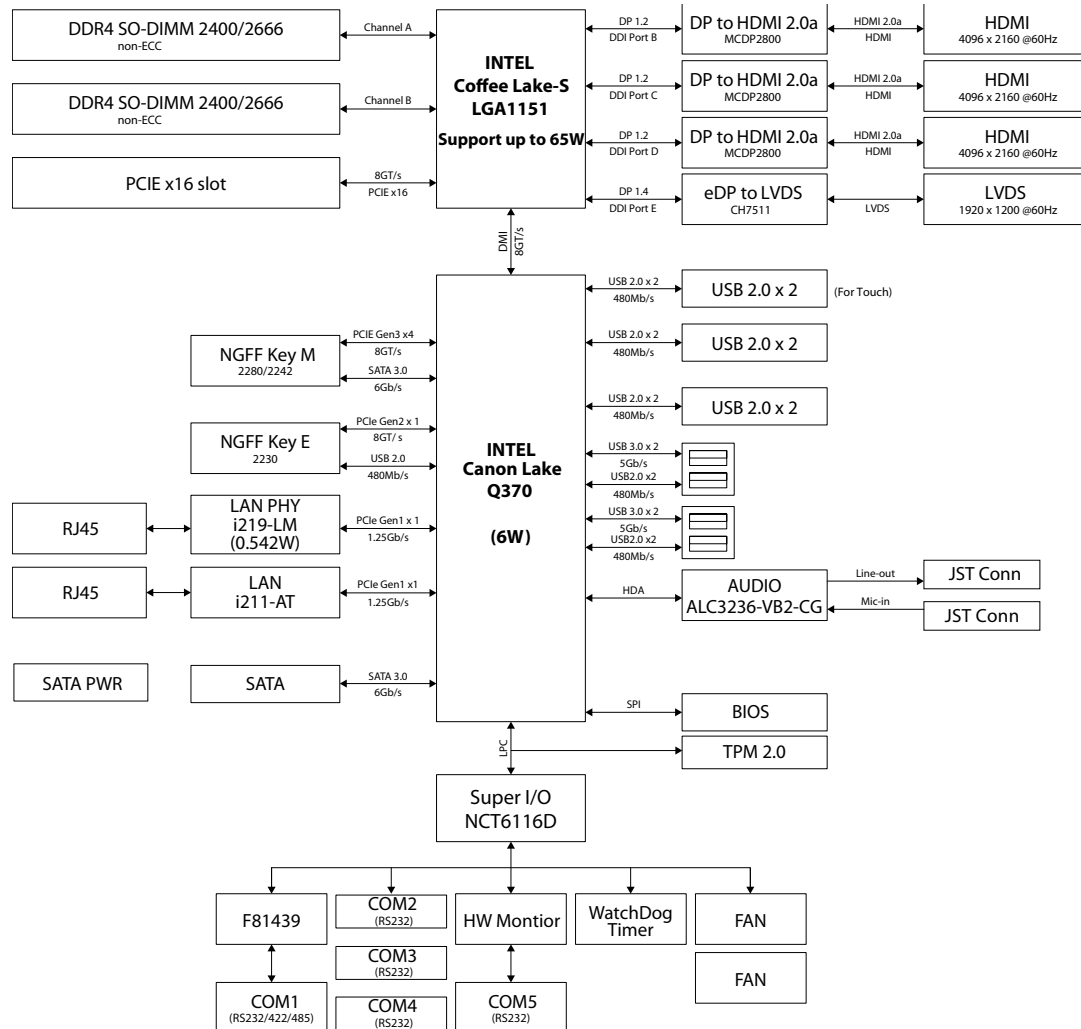

## CHAPTER 2: JUMPERS AND CONNECTORS

This chapter lists the locations of the jumpers and connectors for the Neu-X300-F65 series.

### Before You Begin

- Ensure you have a stable, clean working environment. Dust and dirt can get into components and cause a malfunction. Use containers to keep small components separated.
- Adequate lighting and proper tools can prevent you from accidentally damaging the internal components. Most of the procedures that follow require only a few simple tools, including the following:
  - A Philips screwdriver
  - A flat-tipped screwdriver
  - A set of jewelers screwdrivers
  - A grounding strap
  - An anti-static pad
- Using your fingers can disconnect most of the connections. It is recommended that you do not use needle-nosed pliers to disconnect connections as these can damage the soft metal or plastic parts of the connectors.
- Before working on internal components, make sure that the power is off. Ground yourself before touching any internal components, by touching a metal object. Static electricity can damage many of the electronic components. Humid environments tend to have less static electricity than

dry environments. A grounding strap is warranted whenever danger of static electricity exists.

### Precautions

Computer components and electronic circuit boards can be damaged by discharges of static electricity. Working on computers that are still connected to a power supply can be extremely dangerous.

Follow the guidelines below to avoid damage to your computer or yourself:

- Always disconnect the unit from the power outlet whenever you are working inside the case.
- If possible, wear a grounded wrist strap when you are working inside the computer case. Alternatively, discharge any static electricity by touching the bare metal chassis of the unit case, or the bare metal body of any other grounded appliance.
- Hold electronic circuit boards by the edges only. Do not touch the components on the board unless it is necessary to do so. Don't flex or stress the circuit board.
- Leave all components inside the static-proof packaging that they shipped with until they are ready for installation.
- Use correct screws and do not over tighten screws.

## Jumper Settings

A jumper is the simplest kind of electric switch. It consists of two metal pins and a cap. When setting the jumpers, ensure that the jumper caps are placed on the correct pins. When the jumper cap is placed on both pins, the jumper is short. If you remove the jumper cap, or place the jumper cap on just one pin, the jumper is open.

Refer to the illustrations below for examples of what the 2-pin and 3-pin jumpers look like when they are short (on) and open (off).

Two-Pin Jumpers: Open (Left) and Short (Right)

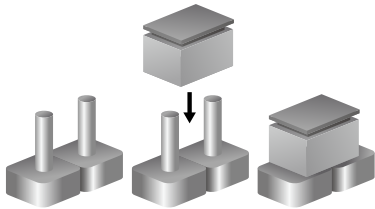

Three-Pin Jumpers: Pins 1 and 2 are Short

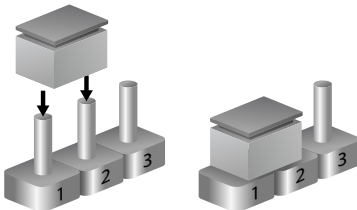

## Locations of the Jumpers and Connectors for the Neu-X300 Series

The figure below is the top and bottom view of the mainboard used in the Neu-X300 series. It shows the locations of the jumpers and connectors.

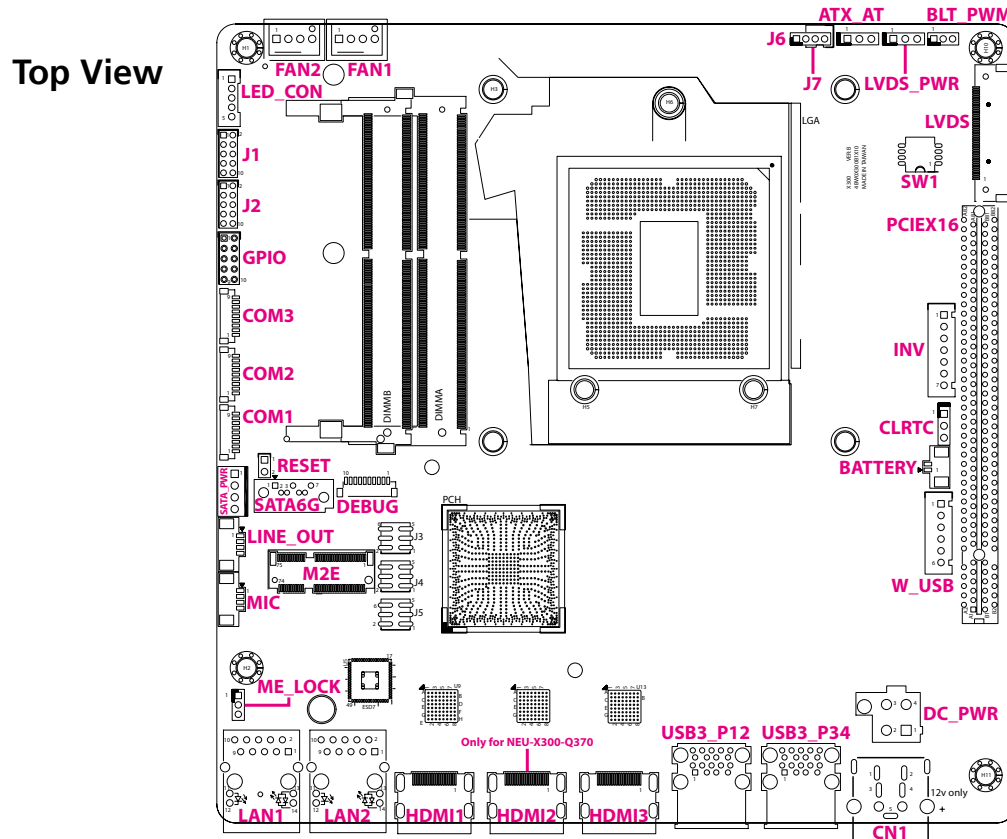

### Bottom View

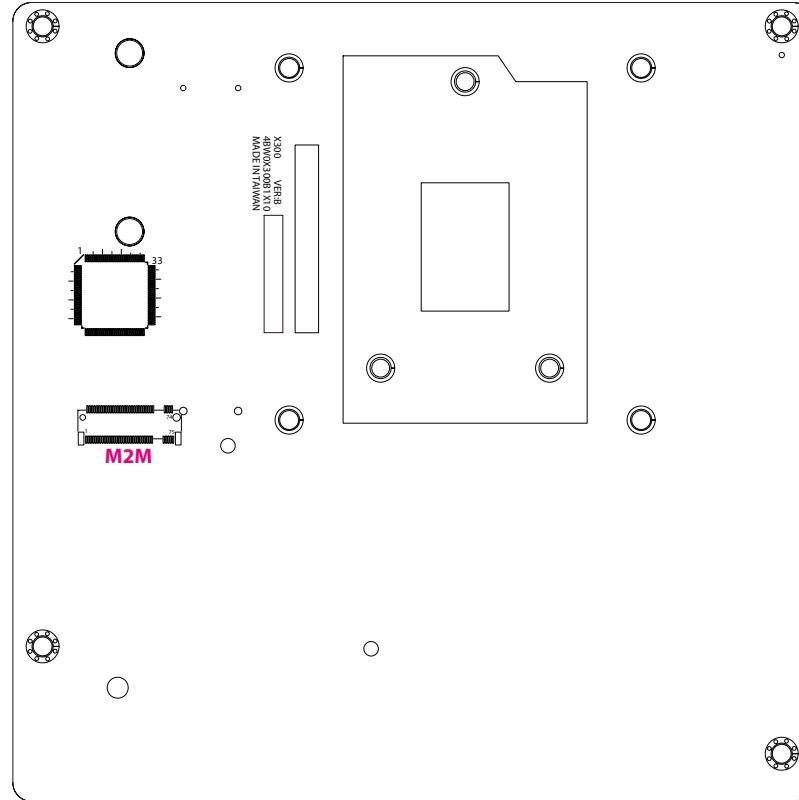



## Jumpers & DIP Switches

### AT/ATX Mode Select

Connector type: 1x3 3-pin header, 2.54mm pitch

Connector location: ATX\_AT

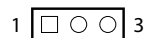

Pin	Settings
1-2 On	ATX Mode
2-3 On	AT Mode

1-2 On: default

### Clear CMOS

Connector type: 1x3 3-pin header, 2.54mm pitch

Connector location: CLRTC

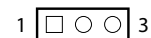

Pin	Settings
1-2 On	Normal
2-3 On	Clear CMOS

1-2 On: default

## LVDS Panel Voltage Select

Connector type: 1x3 3-pin header, 2.54mm pitch

Connector location: LVDS\_PWR

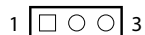

Pin	Settings
1-2 On	3.3V
2-3 On	5V

1-2 On: default

## Backlight Control Voltage Select (Dimming)

Connector type: 1x3 3-pin header, 2.0mm pitch

Connector location: BLT\_PWM

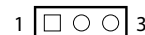

Pin	Settings
1-2 On	3.3V
2-3 On	5V

1-2 On: default

## ME Flash Descriptor Security Override

Connector type: 1x3 3-pin header, 2.0mm pitch

Connector location: ME\_LOCK



Pin	Settings
1-2 On	Lock
2-3 On	Unlock

1-2 On: default

## LVDS Resolution Select

Connector type: 4-pin DIP switch

Connector location: SW1

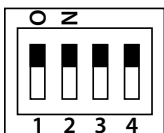

SW [3:0]	SW1 [3]	SW1 [2]	SW1 [1]	SW1 [0]	Function
0000	ON	ON	ON	ON	800 x 600 6-bit Single Port
0001	ON	ON	ON	OFF	1024 x 768 6-bit Single Port
0010	ON	ON	OFF	ON	1024 x 768 8-bit Single Port
0011	ON	ON	OFF	OFF	1280 x 1024 6-bit Single Port
0100	ON	OFF	ON	ON	1280 x 800 6-bit Single Port
0101	ON	OFF	ON	OFF	1280 x 960 6-bit Single Port
0110	ON	OFF	OFF	ON	1280 x 1024 8-bit Dual Port
0111	ON	OFF	OFF	OFF	1366 x 768 6-bit Single Port
1000	OFF	ON	ON	ON	1366 x 768 8-bit Single Port
1001	OFF	ON	ON	OFF	1440 x 900 8-bit Dual Port
1010	OFF	ON	OFF	ON	1400 x 1050 8-bit Dual Port
1011	OFF	ON	OFF	OFF	1600 x 900 8-bit Dual Port
1100	OFF	OFF	ON	ON	1680 x 1050 8-bit Dual Port
1101	OFF	OFF	ON	OFF	1600 x 1200 8-bit Dual Port
1110	OFF	OFF	OFF	ON	1920 x 1080 8-bit Dual Port
1111	OFF	OFF	OFF	OFF	1920 x 1200 8-bit Dual Port

## Connector Pin Definitions

### External I/O Interfaces

#### LAN1 and LAN2 Port

Connector type: RJ45 port with LEDs

Connector location: LAN1 and LAN2

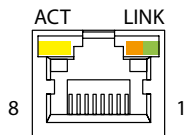

Act	Status
Flashing Yellow	Data activity
Off	No activity

Link	Status
Steady Green	1G network link
Steady Orange	100Mbps network link
Off	10Mbps or no link

Pin	Definition	Pin	Definition
1	MDI_OP	2	MDI_ON
3	MDI_1P	4	MDI_1N
5	CT	6	CT
7	MDI_2P	8	MDI_2N
9	MDI_3P	10	MDI_3N
11	+3VSB	12	ACTLED#
13	LINK100#	14	LINK1000#

#### HDMI1, HDMI2 and HDMI3 Port (HDMI3 Only for Q370)

Connector type: HDMI port

Connector location: HDMI1, HDMI2 and HDMI3



Pin	Definition	Pin	Definition
1	TX2P	2	GND
3	TX2N	4	TX1P
5	GND	6	TX1N
7	TX0P	8	GND
9	TX0N	10	CLKP
11	GND	12	CLKN
13	CEC	14	NC
15	SCL	16	SDA
17	GND	18	+5V
19	HPD		

### USB 3.0 Ports

Connector type: Dual USB 3.0 port

Connector location: USB3\_P12 and USB3\_P34

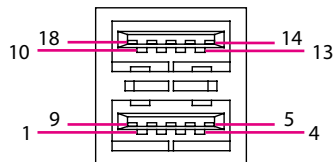

Pin	Definition	Pin	Definition
1	+5V	2	USB2_2N
3	USB2_2P	4	GND
5	USB3_RX2N	6	USB3_RX2P
7	GND	8	USB3_TX2N
9	USB3_TX2P	10	+5V
11	USB2_1N	12	USB2_1P
13	GND	14	USB3_RX1N
15	USB3_RX1P	16	GND
17	USB3_TX1N	18	USB3_TX1P

### DC Power Input (+12V Only)

Connector location: CN1

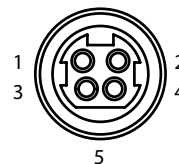

Pin	Definition	Pin	Definition
1	+12VSUS	2	+12VSUS
3	GND	4	GND
5	CGND		

## Internal Connectors

### LVDS Inverter Connector

Connector type: 1x7 7-pin header JST, 2.5mm pitch

Connector location: INV

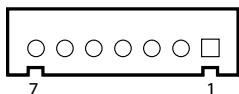

Pin	Definition	Pin	Definition
1	5V	2	12V
3	12V	4	Backlight Control
5	GND	6	GND
7	Backlight Enable		

### System Reset Header

Connector type: 1x2 2-pin header, 2.54mm pitch

Connector location: RESET



Pin	Definition
1	RESET#
2	GND

## LED Connector

Connector type: 1x5 5-pin header JST, 2.0mm pitch

Connector location: LED\_CON

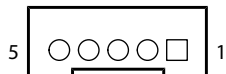

Pin	Definition	Pin	Definition
1	HDD_LED-	2	HDD_LED+
3	GND	4	Standby LED
5	PWR LED		

## Line-out Connector

Connector type: 1x4 4-pin header, 1.25mm pitch

Connector location: LINE\_OUT

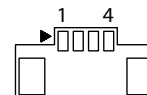

Pin	Definition	Pin	Definition
1	LOUT_L	2	GND
3	LOUT_JD	4	LOUT_R



## Mic-in Connector

Connector type: 1x4 4-pin header, 1.25mm pitch

Connector location: MIC

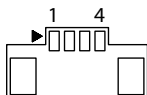

Pin	Definition	Pin	Definition
1	MIC_L	2	GND
3	MIC_JD	4	MIC_R

## System Power Button Header

Connector type: 1x2 2-pin header JST, 2.0mm pitch

Connector location: J7

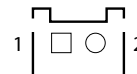

Pin	Definition
1	PWRBTN#
2	GND

## FAN Connectors

Connector type: 1x4 4-pin header, 2.54mm pitch

Connector location: FAN1 and FAN2

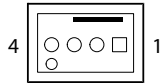

Pin	Definition	Pin	Definition
1	GND	2	+12V
3	FAN SPEED DETECT	4	FAN SPEED CONTROL

## Debug Port/LPC Bus Connector

Connector type: 1x10 10-pin header, 1.0mm pitch

Connector location: DEBUG

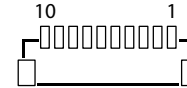

Pin	Definition	Pin	Definition
1	+3V	2	SERIRQ
3	LAD0	4	LAD1
5	LAD2	6	LAD3
7	LFRAME#	8	24MHZ
9	PLTRST#	10	GND

## COM Port Connectors

Connector type: 1x9 9-pin header, 1.0mm pitch

Connector location: COM1, COM2 and COM3



Pin	Definition	Pin	Definition
1	DCD	2	RXD
3	TXD	4	DTR
5	GND	6	DSR
7	RTS	8	CTS
9	RI		

## Battery Connector

Connector type: 1x2 2-pin header, 1.25mm pitch

Connector location: BATTERY



Pin	Definition
1	BAT
2	GND

## LVDS Panel Connector

Connector type: 1x40 40-pin header, 0.5mm pitch

Connector location: LVDS

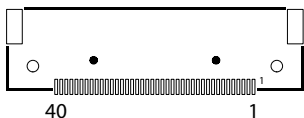

Pin	Definition	Pin	Definition
1	LVDS0_D3+	2	LVDS0_D3-
3	LVDS0_D2+	4	LVDS0_D2-
5	LVDS0_D1+	6	LVDS0_D1-
7	LVDS0_D0+	8	LVDS0_D0-
9	LVDS1_D3+	10	LVDS1_D3-
11	LVDS1_D2+	12	LVDS1_D2-
13	LVDS1_D1+	14	LVDS1_D1-
15	LVDS1_D0+	16	LVDS1_D0-
17	GND	18	+V_PANEL (3.3V or 5V)
19	+V_PANEL (3.3V or 5V)	20	+V_PANEL (3.3V or 5V)
21	GND	22	3.3V
23	GND	24	GND
25	GND	26	LVDS0_CLK+
27	LVDS0_CLK-	28	GND
29	GND	30	GND
31	SMBUS_CLK	32	Backlight Enable
33	Backlight Control	34	LVDS1_CLK+
35	LVDS1_CLK-	36	+12V
37	+12V	38	+12V
39	NC	40	SMBUS_DAT

## Internal USB 2.0 Connectors

Connector type: 2x5 10-pin header, 2.0mm pitch

Connector location: J1 and J2

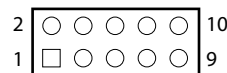

Pin	Definition	Pin	Definition
1	5V	2	GND
3	USB1N	4	GND
5	USB1P	6	USB2P
7	GND	8	USB2N
9	GND	10	5V

## USB Touch

Connector type: 1x6 6-pin header JST, 2.5mm pitch

Connector location: W\_USB

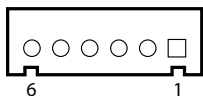

Pin	Definition	Pin	Definition
1	5V	2	USB1N
3	USB1P	4	USB2N
5	USB2P	6	GND

## ATX 4-pin Connector

Connector type: 1x4 4-pin header

Connector location: DC\_PWR

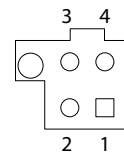

Pin	Definition	Pin	Definition
1	+12VSUS	2	+12VSUS
3	GND	4	GND

## SATA Connector

Connector type: Standard Serial ATA 7P (1.27mm, SATA-M-180)

Connector location: SATA6G

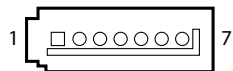

Pin	Definition	Pin	Definition
1	GND	2	SATA_TXP
3	SATA_TXN	4	GND
5	SATA_RXN	6	SATA_RXP
7	GND		

## SATA Power Connector

Connector type: 1x4 4-pin header, 2.5mm pitch

Connector location: SATA\_PWR

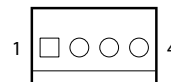

Pin	Definition	Pin	Definition
1	+5V	2	GND
3	GND	4	+12V

## System Power Button Connector

Connector type: 1x4 4-pin header, 2.0mm pitch

Connector location: J6

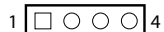

Pin	Definition	Pin	Definition
1	+5V	2	GND
3	PWRBTN#	4	GND

## GPIO Connector

Connector type: 2x5 10-pin header, 2.0mm pitch

Connector location: J8

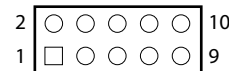

Pin	Definition	Pin	Definition
1	+5V	2	GND
3	SIO_GP10	4	SIO_GP11
5	SIO_GP12	6	SIO_GP13
7	SIO_GP14	8	SIO_GP15
9	SIO_GP16	10	SIO_GP17

## PCIe Slot Setting

Connector type: 2x3 6-pin header, 2.0mm pitch

Connector location: PCIE\_SW

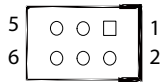

Pin	Function	
1-3	1 x16 PCI Express	Default
2-4		

Pin	Function	
3-5	2 x8 PCI Express	
2-4		



## M.2 Connector (M-Key)

Connector location: M2M

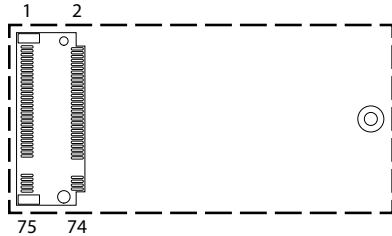

Pin	Definition	Pin	Definition
1	GND	2	+3VSB
3	GND	4	+3VSB
5	PCIE4_RXN	6	NC
7	PCIE4_RXP	8	NC
9	GND	10	M2M_LED#
11	PCIE4_RXN	12	+3VSB
13	PCIE4_RXP	14	+3VSB
15	GND	16	+3VSB
17	PCIE3_RXN	18	+3VSB
19	PCIE3_RXP	20	NC
21	GND	22	NC
23	PCIE3_RXN	24	NC
25	PCIE3_RXP	26	NC
27	GND	28	NC
29	PCIE2_RXN	30	NC
31	PCIE2_RXP	32	NC
33	GND	34	NC
35	PCIE2_RXN	36	NC
37	PCIE2_RXP	38	DEVSLP

Pin	Definition	Pin	Definition
39	GND	40	NC
41	SATA_RXP(PCIE1_RXP)	42	NC
43	SATA_RXN(PCIE1_RXN)	44	NC
45	GND	46	NC
47	SATA_TXN(PCIE1_TXN)	48	NC
49	SATA_TXP(PCIE1_TXP)	50	RESET#
51	GND	52	CLKREQ#
53	CLK_PCIEN	54	WAKE#
55	CLK_PCIEP	56	NC
57	GND	58	NC
67	NC	68	
69	M2M_PEDET	70	+3VSB
71	GND	72	+3VSB
73	GND	74	+3VSB
75	GND		

## M.2 Connector (E-Key)

Connector location: M2E

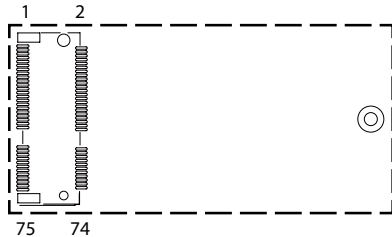

Pin	Definition	Pin	Definition
1	GND	2	3VSB
3	USBP	4	3VSB
5	USBN	6	NC
7	GND	8	NC
9	NC	10	NC
11	NC	12	NC
13	NC	14	NC
15	NC	16	NC
17	NC	18	NC
19	NC	20	NC
21	NC	22	NC
23	NC		
		32	NC
33	GND	34	NC
35	PCIE_TXP	36	NC
37	PCIE_TXN	38	NC
39	GND	40	NC
41	PCIE_RXP	42	NC

Pin	Definition	Pin	Definition
43	PCIE_RXN	44	NC
45	GND	46	NC
47	CLK_PCIEP	48	NC
49	CLK_PCIEN	50	SUSCLK
51	GND	52	PLTRST#
53	CLKREQ#	54	BT_DISABLE#
55	WAKE#	56	WIFI_DISABLE#
57	GND	58	NC
59	NC	60	NC
61	NC	62	NC
63	GND	64	NC
65	NC	66	NC
67	NC	68	NC
69	GND	70	NC
71	NC	72	3VSB
73	NC	74	3VSB
75	GND		

## PCIe x16 Slot

Connector location: PCIEX16



Pin	Definition	Pin	Definition
A1	GND	B1	+12V
A2	+12V	B2	+12V
A3	+12V	B3	+12V
A4	GND	B4	GND
A5	NC	B5	SMBCLK
A6	NC	B6	SMBDAT
A7	NC	B7	GND
A8	NC	B8	+3.3V
A9	+3.3V	B9	NC
A10	+3.3V	B10	+3VSUS
A11	PCIRST#	B11	WAKE#
A12	GND	B12	NC
A13	CLK_PCIEP	B13	GND
A14	CLK_PCIEN	B14	TXP0
A15	GND	B15	TXN0
A16	RXP0	B16	GND
A17	RXN0	B17	PCIEX16_PRSENT#
A18	GND	B18	GND

Pin	Definition	Pin	Definition
A19	NC	B19	TXP1
A20	GND	B20	TXN1
A21	RXP1	B21	GND
A22	RXN1	B22	GND
A23	GND	B23	TXP2
A24	GND	B24	TXN2
A25	RXP2	B25	GND
A26	RXN2	B26	GND
A27	GND	B27	TXP3
A28	GND	B28	TXN3
A29	RXP3	B29	GND
A30	RXN3	B30	NC
A31	GND	B31	NC
A32	NC	B32	GND
A33	NC	B33	TXP4
A34	GND	B34	TXN4
A35	RXP4	B35	GND
A36	RXN4	B36	GND

Pin	Definition	Pin	Definition
A37	GND	B37	TXP5
A38	GND	B38	TXN5
A39	RXP5	B39	GND
A40	RXN5	B40	GND
A41	GND	B41	TXP6
A42	GND	B42	TXN6
A43	RXP6	B43	GND
A44	RXN6	B44	GND
A45	GND	B45	TXP7
A46	GND	B46	TXN7
A47	RXP7	B47	GND
A48	RXN7	B48	NC
A49	GND	B49	GND
A50	NC	B50	TXP8
A51	GND	B51	TXN8
A52	RXP8	B52	GND
A53	RXN8	B53	GND
A54	GND	B54	TXP9
A55	GND	B55	TXN9
A56	RXP9	B56	GND
A57	RXN9	B57	GND
A58	GND	B58	TXP10
A59	GND	B59	TXN10

Pin	Definition	Pin	Definition
A60	RXP10	B60	GND
A61	RXN10	B61	GND
A62	GND	B62	TXP11
A63	GND	B63	TXN11
A64	RXP11	B64	GND
A65	RXN11	B65	GND
A66	GND	B66	TXP12
A67	GND	B67	TXN12
A68	RXP12	B68	GND
A69	RXN12	B69	GND
A70	GND	B70	TXP13
A71	GND	B71	TXN13
A72	RXP13	B72	GND
A73	RXN13	B73	GND
A74	GND	B74	TXP14
A75	GND	B75	TXN14
A76	RXP14	B76	GND
A77	RXN14	B77	GND
A78	GND	B78	TXP15
A79	GND	B79	TXN15
A80	RXP15	B80	GND
A81	RXN15	B81	NC
A82	GND	B82	NC

## CHAPTER 3: SYSTEM SETUP

### Removing the Bottom Cover from the Chassis



Prior to removing the chassis cover, make sure the unit's power is off and disconnected from the power sources to prevent electric shock or system damage.

1. The three screws on the left, right and rear are used to secure the cover to the chassis. Remove these screws and put them in a safe place for later use.



## Installing an M.2 M-Key SSD Module (M-Key 2280)

1. On the bottom of the system, loosen the screws on the bottom cover, and then remove the cover from the chassis.
2. Remove the screw on the standoff and put it in a safe place for later use.

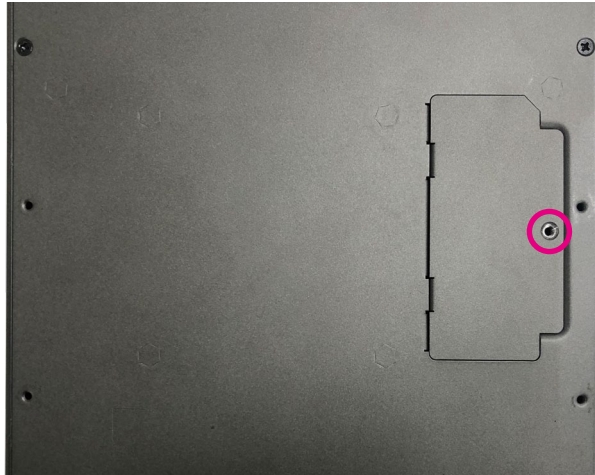

3. Insert the M.2 SSD module into the M.2 slot at a 45-degree angle until the gold-plated connector on the edge of the module completely disappears. With the module fully inserted, tighten the screw removed earlier into the mounting hole on the module to secure it.



## Installing a SO-DIMM Memory Module

1. With the bottom cover removed, install a memory module in the SO-DIMM socket. Insert the module into the socket at an approximately 30-degree angle. Push the module down until the clips on both sides of the socket lock into position. The gold-plated connector on the edge of the module will almost completely disappear inside the socket.

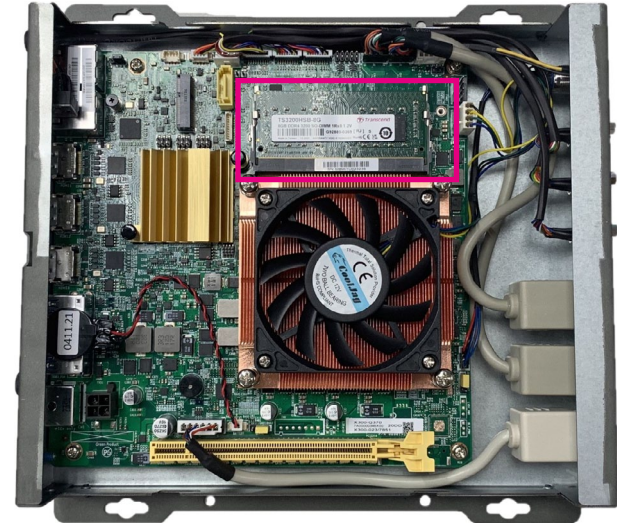
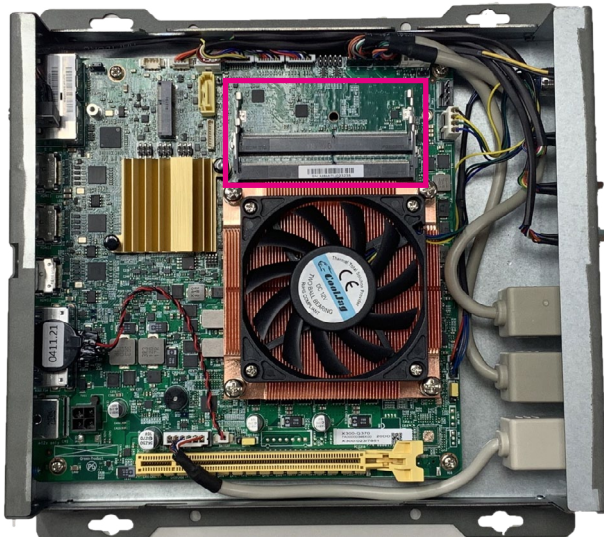



## Installing a Wi-Fi Module (M.2 E-Key Slot)

1. With the bottom cover removed, insert the Wi-Fi module into the slot at a 45-degree angle until the gold-plated connector on the edge of the module completely disappears inside the slot.
2. Push the module down and tighten a screw into the mounting hole on the module to secure it.

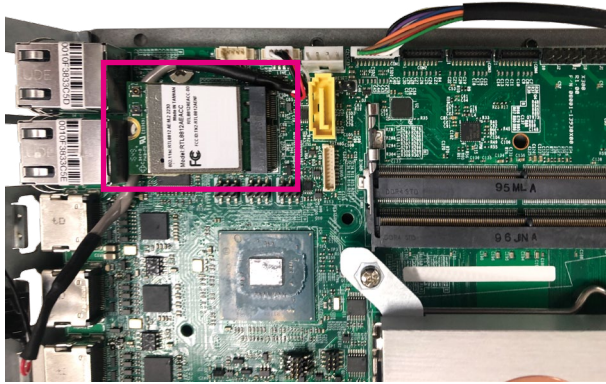

3. Attach the RF cable onto the Wi-Fi module and remove the antenna hole cover on the rear panel. Then insert the antenna jack end of the cable through the antenna hole.

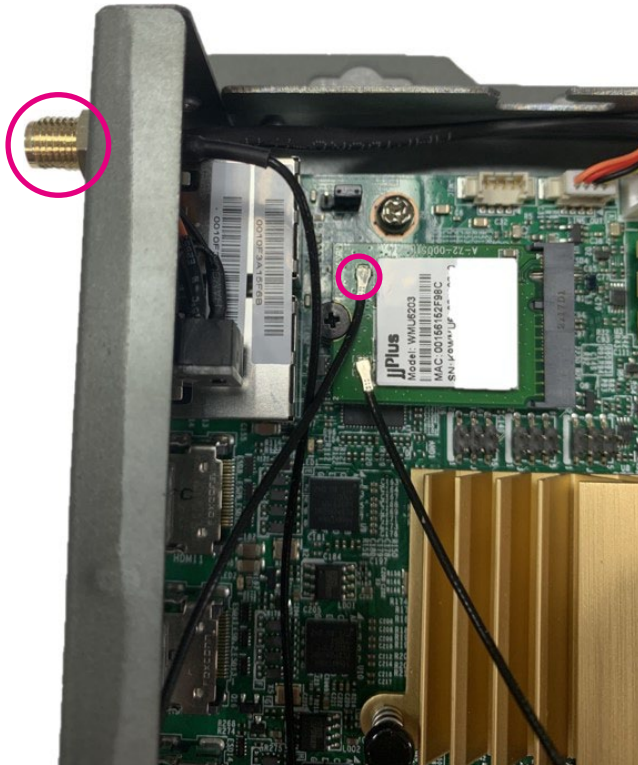

4. Insert the 2 rings (ring 1 then ring 2) into the Wi-Fi antenna jacks.

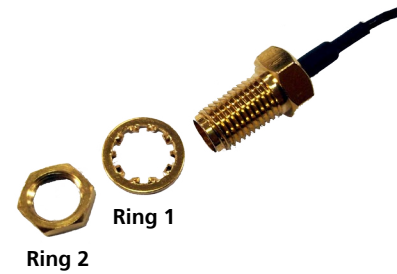

5. Connect the external antenna to the Wi-Fi antenna jack.



## Installing a CPU

1. Loosen the four mounting screws on the CPU cooler then remove it to access the CPU socket.



2. Unlock the socket by pushing the load lever down, moving it sideways until it is released from the retention tab; then lift the load lever up.

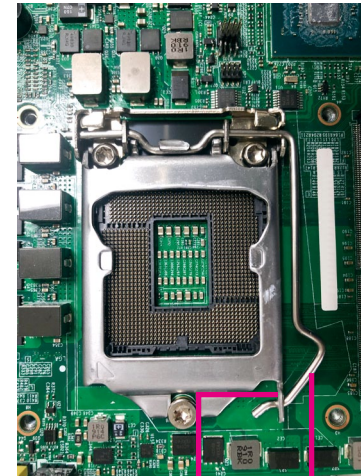

Retention Tab

Load Lever

3. Insert the CPU into the socket. The triangular edge on the CPU must align with the corner of the CPU socket shown on the photo.

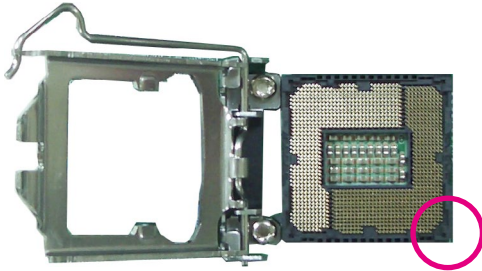

The CPU's notch will at the same time fit into the socket's alignment key.

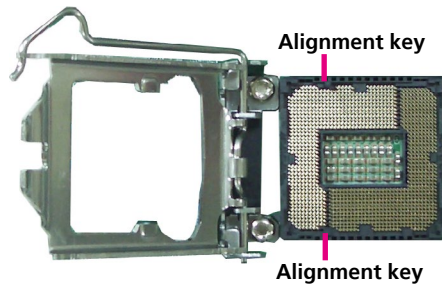

4. Close the load plate and then hook the load lever under the retention tab.

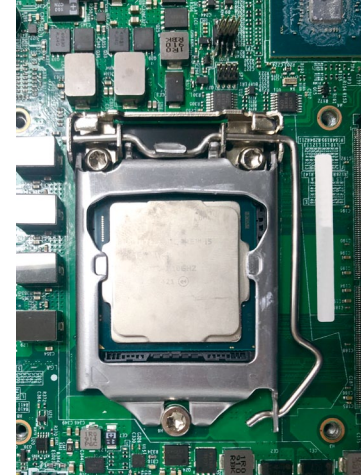

- Handle the CPU by its edges and avoid touching the pins.
- The CPU will fit in only one orientation and can easily be inserted without exerting any force.



Do not force the CPU into the socket. Forcing the CPU into the socket may bend the pins and damage the CPU.

5. Reinstall the CPU cooler with the four mounting screws removed earlier.

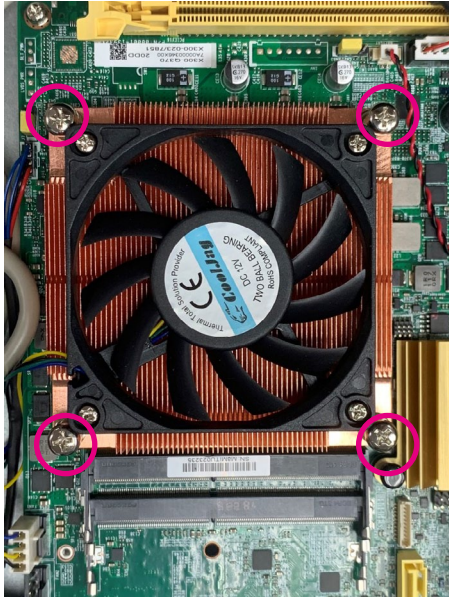

## Wall Mounting Instructions

To mount the system on to a wall or some other surface using the two mounting brackets, please follow the steps below.

1. Turn the system to left and right side. Align the two retention screw holes in each bracket with the retention screw holes.
2. Secure the brackets to the system by inserting two retention screws into each bracket.



Specification of the wall mount screw:  
Round Head Screw Long Fei:P6#32TX8L\_w/Spring+Flat Washer

3. Drill holes in the intended installation surface.
4. Align the mounting holes on the sides of the mounting brackets with the predrilled holes on the mounting surface.
5. Insert four retention screws, two in each bracket, to secure the system to the wall.

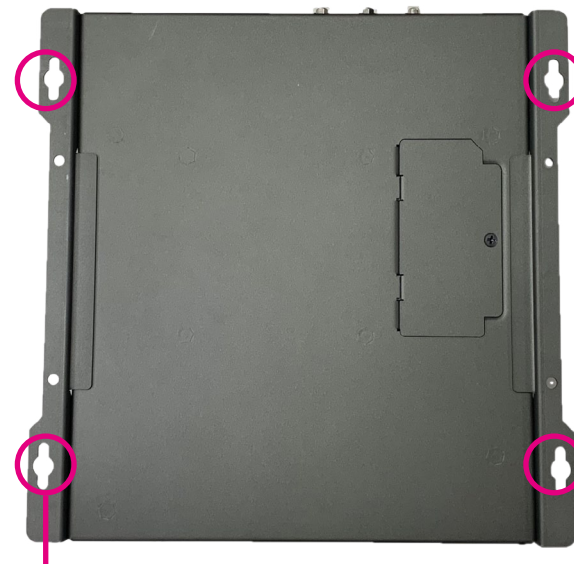

**Fasten screws to mount the system to the wall**

# CHAPTER 4: BIOS SETUP

This chapter describes how to use the BIOS setup program for the Neu-X300-F65 series. The BIOS screens provided in this chapter are for reference only and may change if the BIOS is updated in the future.

To check for the latest updates and revisions, visit the NEXCOM website at [www.nexcom.com.tw](http://www.nexcom.com.tw).

## About BIOS Setup

The BIOS (Basic Input and Output System) Setup program is a menu driven utility that enables you to make changes to the system configuration and tailor your system to suit your individual work needs. It is a ROM-based configuration utility that displays the system's configuration status and provides you with a tool to set system parameters.

These parameters are stored in non-volatile battery-backed-up CMOS RAM that saves this information even when the power is turned off. When the system is turned back on, the system is configured with the values found in CMOS.

With easy-to-use pull down menus, you can configure such items as:

- Hard drives, diskette drives, and peripherals
- Video display type and display options
- Password protection from unauthorized use
- Power management features

The settings made in the setup program affect how the computer performs. It is important, therefore, first to try to understand all the setup options, and second, to make settings appropriate for the way you use the computer.

## When to Configure the BIOS

- This program should be executed under the following conditions:
  - When changing the system configuration
  - When a configuration error is detected by the system and you are prompted to make changes to the setup program
  - When resetting the system clock
  - When redefining the communication ports to prevent any conflicts
  - When making changes to the Power Management configuration
  - When changing the password or making other changes to the security setup

Normally, CMOS setup is needed when the system hardware is not consistent with the information contained in the CMOS RAM, whenever the CMOS RAM has lost power, or the system features need to be changed.



## Default Configuration

Most of the configuration settings are either predefined according to the Load Optimal Defaults settings which are stored in the BIOS or are automatically detected and configured without requiring any actions. There are a few settings that you may need to change depending on your system configuration.

## Entering Setup











When the system is powered on, the BIOS will enter the Power-On Self Test (POST) routines. These routines perform various diagnostic checks; if an error is encountered, the error will be reported in one of two different ways:

- If the error occurs before the display device is initialized, a series of beeps will be transmitted.
- If the error occurs after the display device is initialized, the screen will display the error message.

Powering on the computer and immediately pressing <Del> allows you to enter Setup.

Press the  key to enter Setup:

## Legends

Key	Function
	Moves the highlight left or right to select a menu.
	Moves the highlight up or down between sub-menus or fields.
	Exits the BIOS Setup Utility.
	Scrolls forward through the values or options of the highlighted field.
	Scrolls backward through the values or options of the highlighted field.
	Selects a field.
	Displays General Help.
	Load previous values.
	Load optimized default values.
	Saves and exits the Setup program.
	Press <Enter> to enter the highlighted sub-menu

## Scroll Bar

When a scroll bar appears to the right of the setup screen, it indicates that there are more available fields not shown on the screen. Use the up and down arrow keys to scroll through all the available fields.

## Submenu

When “▶” appears on the left of a particular field, it indicates that a submenu which contains additional options are available for that field. To display the submenu, move the highlight to that field and press  .

## BIOS Setup Utility

Once you enter the AMI BIOS Setup Utility, the Main Menu will appear on the screen. The main menu allows you to select from several setup functions and one exit. Use arrow keys to select among the items and press  to accept or enter the submenu.

### Main

The Main menu is the first screen that you will see when you enter the BIOS Setup Utility.

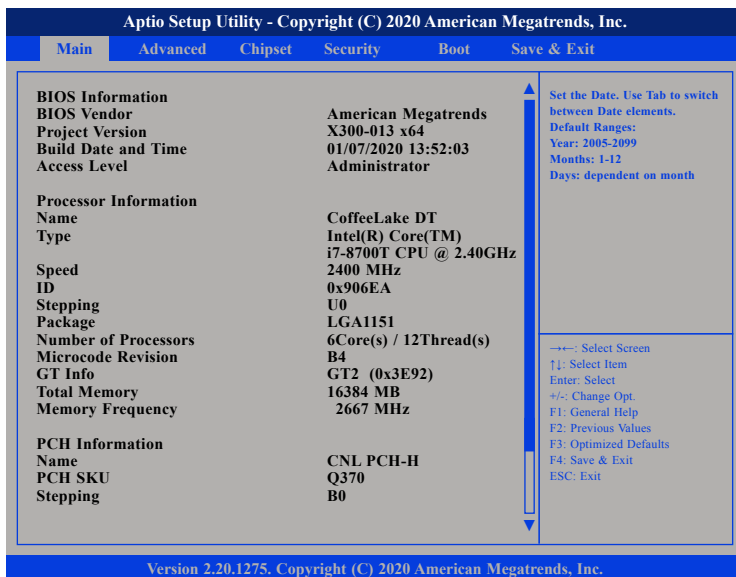

Aptio Setup Utility - Copyright (C) 2020 American Megatrends, Inc.	
Main    Advanced    Chipset    Security    Boot    Save & Exit	
<b>BIOS Information</b>	
BIOS Vendor	American Megatrends
Project Version	X300-013 x64
Build Date and Time	01/07/2020 13:52:03
Access Level	Administrator
<b>Processor Information</b>	
Name	CoffeeLake DT
Type	Intel(R) Core(TM) i7-8700T CPU @ 2.40GHz
Speed	2400 MHz
ID	0x906EA
Stepping	U0
Package	LGA1151
Number of Processors	6Core(s) / 12Thread(s)
Microcode Revision	B4
GT Info	GT2 (0x3E92)
Total Memory	16384 MB
Memory Frequency	2667 MHz
<b>PCH Information</b>	
Name	CNL PCH-H
PCH SKU	Q370
Stepping	B0

Set the Date. Use Tab to switch between Date elements.  
Default Ranges:  
Year: 2005-2099  
Months: 1-12  
Days: dependent on month

←: Select Screen  
↑: Select Item  
Enter: Select  
+/-: Change Opt.  
F1: General Help  
F2: Previous Values  
F3: Optimized Defaults  
F4: Save & Exit  
ESC: Exit

Version 2.20.1275. Copyright (C) 2020 American Megatrends, Inc.

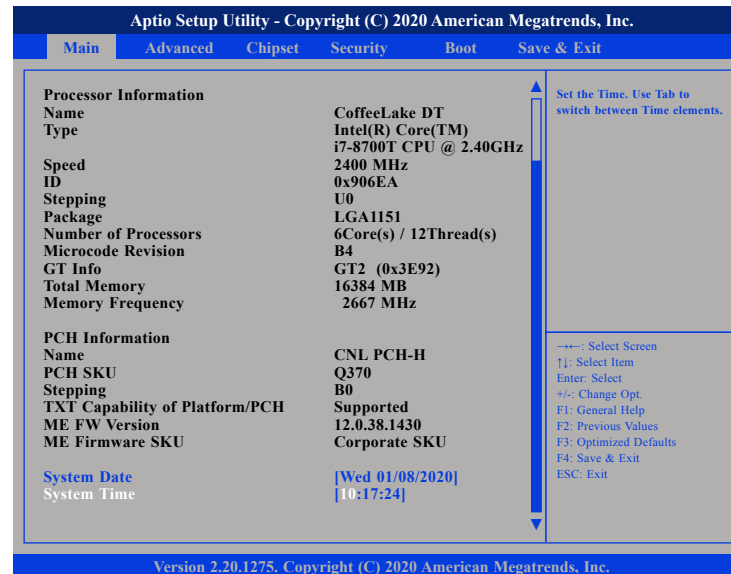

Aptio Setup Utility - Copyright (C) 2020 American Megatrends, Inc.	
Main    Advanced    Chipset    Security    Boot    Save & Exit	
<b>Processor Information</b>	
Name	CoffeeLake DT
Type	Intel(R) Core(TM) i7-8700T CPU @ 2.40GHz
Speed	2400 MHz
ID	0x906EA
Stepping	U0
Package	LGA1151
Number of Processors	6Core(s) / 12Thread(s)
Microcode Revision	B4
GT Info	GT2 (0x3E92)
Total Memory	16384 MB
Memory Frequency	2667 MHz
<b>PCH Information</b>	
Name	CNL PCH-H
PCH SKU	Q370
Stepping	B0
<b>TXT Capability of Platform/PCH</b>	Supported
ME FW Version	12.0.38.1430
ME Firmware SKU	Corporate SKU
<b>System Date</b>	[Wed 01/08/2020]
System Time	[10:17:24]

Set the Time. Use Tab to switch between Time elements.

←: Select Screen  
↑: Select Item  
Enter: Select  
+/-: Change Opt.  
F1: General Help  
F2: Previous Values  
F3: Optimized Defaults  
F4: Save & Exit  
ESC: Exit

Version 2.20.1275. Copyright (C) 2020 American Megatrends, Inc.

### System Date

The date format is <day>, <month>, <date>, <year>. Day displays a day, from Monday to Sunday. Month displays the month, from January to December. Date displays the date, from 1 to 31. Year displays the year, from 2005 to 2099.

### System Time

The time format is <hour>, <minute>, <second>. The time is based on the 24-hour military-time clock. For example, 1 p.m. is 13:00:00. Hour displays hours from 00 to 23. Minute displays minutes from 00 to 59. Second displays seconds from 00 to 59.

## Advanced

The Advanced menu allows you to configure your system for basic operation. Some entries are defaults required by the system board, while others, if enabled, will improve the performance of your system or let you set some features according to your preference.



Setting incorrect field values may cause the system to malfunction.



## CPU Configuration

This section is used to view CPU status and configure CPU parameters.

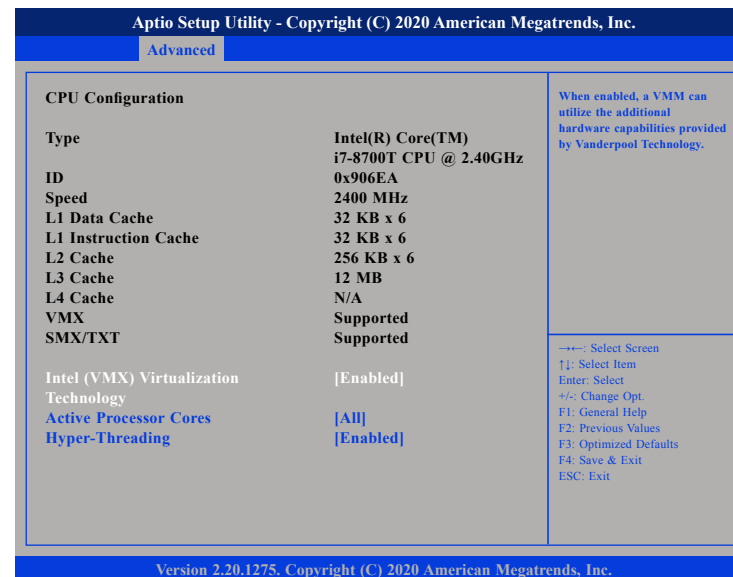

### Intel® (VMX) Virtualization Technology

When this field is set to Enabled, the VMM can utilize the additional hardware capabilities provided by Vanderpool Technology.

### Active Processor Cores

Select the number of cores to enable in each processor package.

### Hyper-threading

Enables or disables hyper-threading technology.

## Power & Performance

This section is used to configure the CPU power management features.

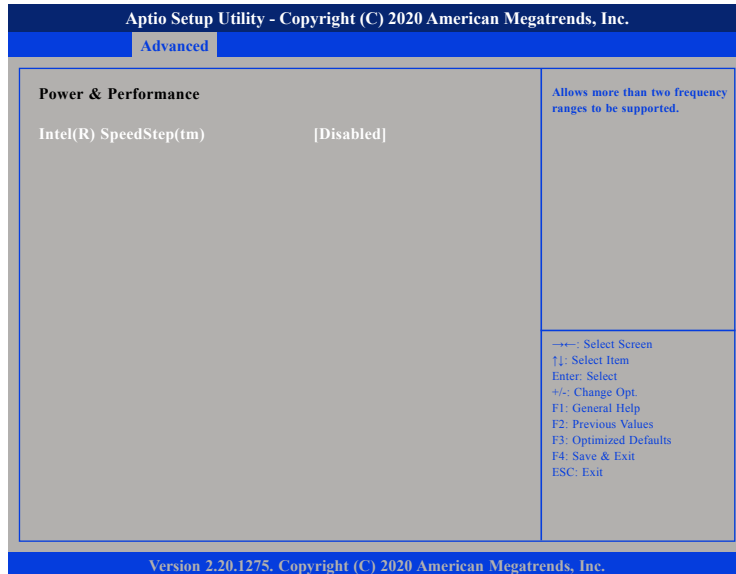

### Intel® SpeedStep

Enables or disables Intel Speedstep technology.

## Trusted Computing

This section is used to configure Trusted Platform Module (TPM) settings.

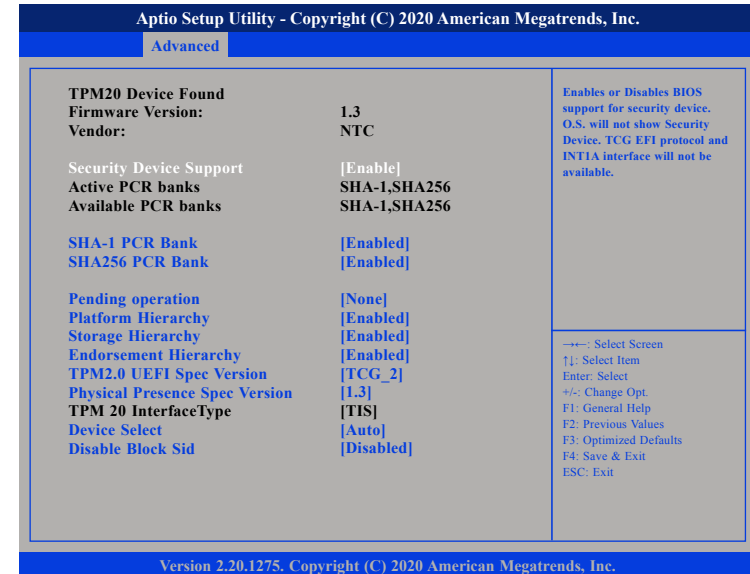

### Security Device Support

Enables or disables BIOS support for security device. O.S will not show Security Device. TCG EFI protocol and INT1A interface will not be available.

### SHA-1 PCR Bank

Enables or disables SHA-1 PCR Bank.

### SHA256 PCR Bank

Enables or disables SHA256 PCR Bank.

### Pending operation

Schedules an operation for the security device.

### Platform Hierarchy

Enables or disables Platform Hierarchy.

### Storage Hierarchy

Enables or disables Storage Hierarchy.

### Endorsement Hierarchy

Enables or disables Endorsement Hierarchy.

### TPM2.0 UEFI Spec Version

Configures the TPM2.0 UEFI spec version.

TCG\_1\_2: The compatible mode for Windows 8/Windows 10.

TCG\_2: Support new TCG2 protocol and event format for Windows 10 or later.

### Physical Presence Spec Version

Configures which physical presence spec version the OS will support. Please note that some HCK tests might not support 1.3.

### Device Select

TPM 1.2 will restrict support to TPM 1.2 devices. TPM 2.0 will restrict support to TPM 2.0 devices. Auto will support both TPM 1.2 and 2.0 devices with the default set to TPM 2.0 devices if not found, and TPM 1.2 devices will be enumerated.

### Disable Block Sid

Enables or disables the option to allow SID authentication in TCG storage device.

## ACPI Settings

This section is used to configure ACPI settings.

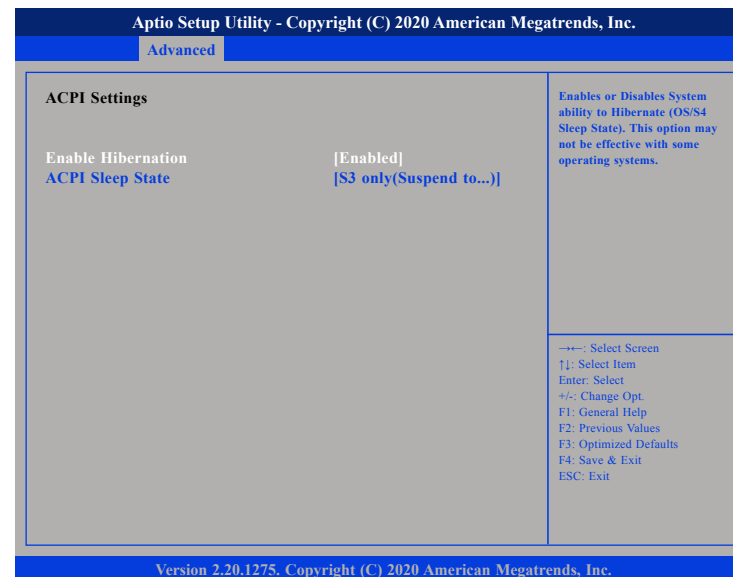

### Enable Hibernation

Enables or disables system ability to hibernate (OS/S4 Sleep State). This option may not be effective with some OS.

### ACPI Sleep State

Select the highest ACPI sleep state the system will enter when the suspend button is pressed. The options are Suspend Disabled and S3 (Suspend to RAM).

## NCT6116D Super IO Configuration

This section is used to configure the serial ports.

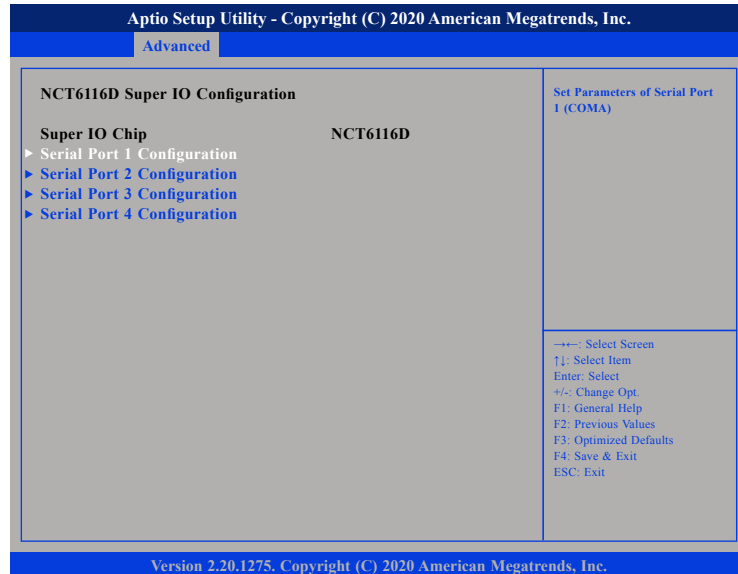

### Super IO Chip

Displays the Super I/O chip used on the board.

## Serial Port 1 Configuration

This section is used to configure serial port 1.

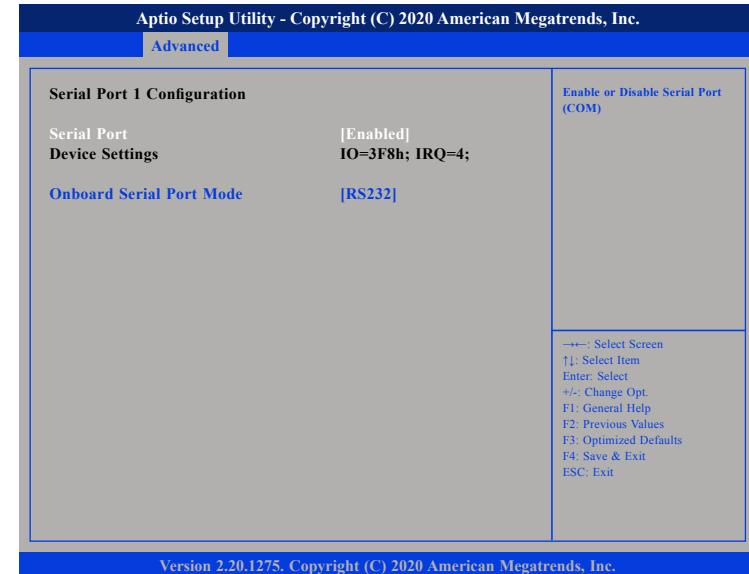

### Serial Port

Enables or disables the serial port.

### Onboard Serial Port Mode

Select this to change the serial port mode to RS232, RS422, RS485 No Terminator or RS485 With Terminator.

## Serial Port 2 Configuration

This section is used to configure serial port 2.

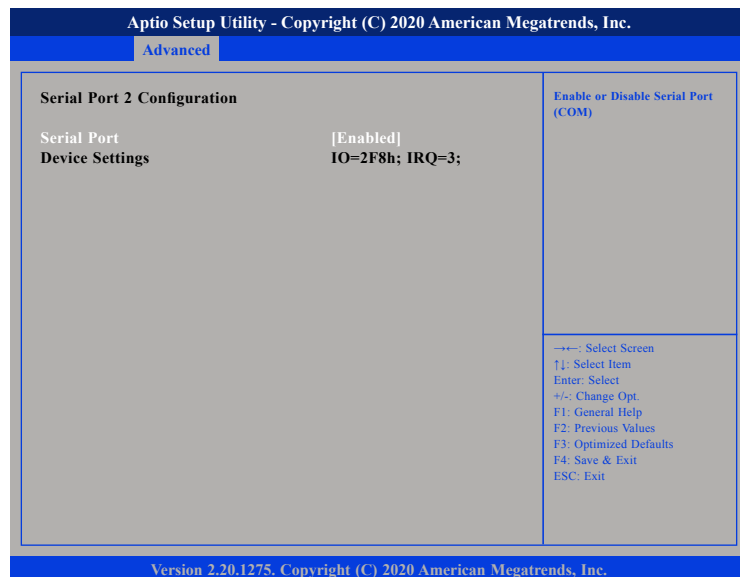

### Serial Port

Enables or disables the serial port.

## Serial Port 3 Configuration

This section is used to configure serial port 3.

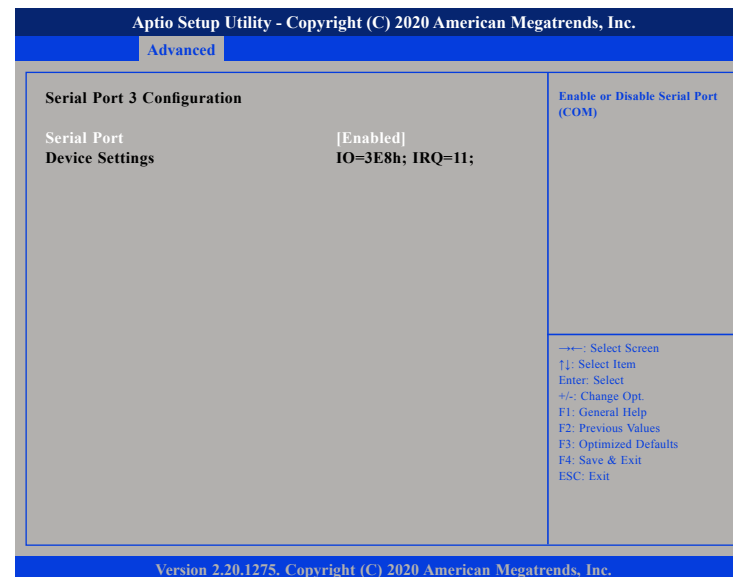

### Serial Port

Enables or disables the serial port.



## Serial Port 4 Configuration

This section is used to configure serial port 4.



### Serial Port

Enables or disables the serial port.

## NCT6116D HW Monitor

This section is used to monitor hardware status such as temperature, fan speed and voltages.

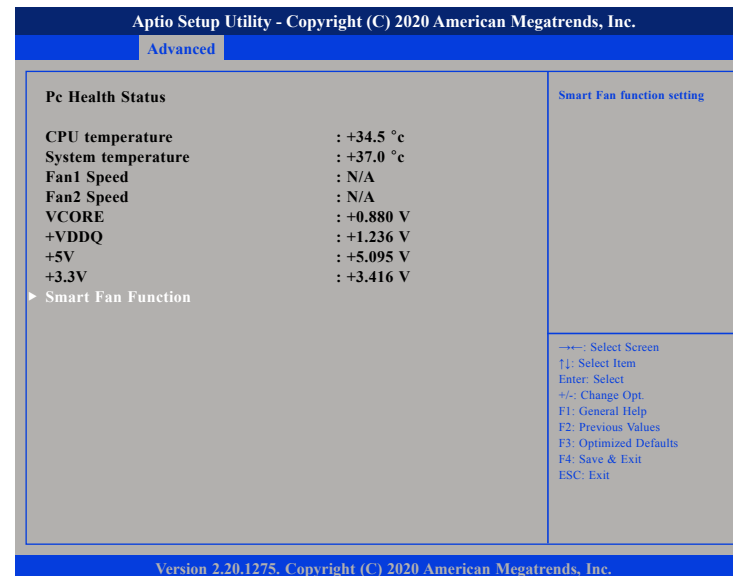

### CPU temperature

Detects and displays the current CPU temperature.

### System temperature

Detects and displays the current system temperature.

### Fan1 and Fan2 Speed

Detects and displays the current fan speed of the fans connected to Fan 1 and Fan 2.

### VCORE to +3.3V

Detects and displays the output voltages.

## Smart Fan Function

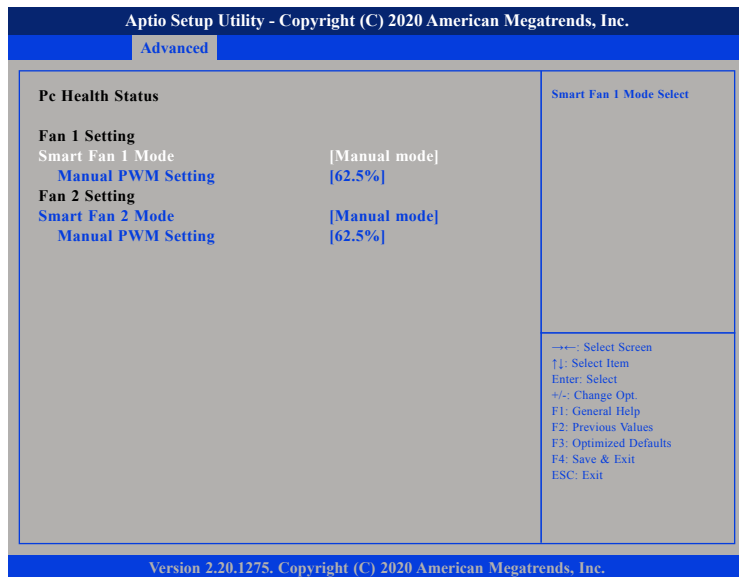

### Smart Fan 1 and Smart Fan 2 Mode

Enables or disables Smart Fan Mode for Fan 1 and Fan 2.

### Manual PWM Setting (Fan 1 and Fan 2)

Configures the fan speed of Fan 1 and Fan 2 manually when the fan mode is set to Manual mode.

## NVMe Configuration

This section is used to configure the NVMe devices installed.

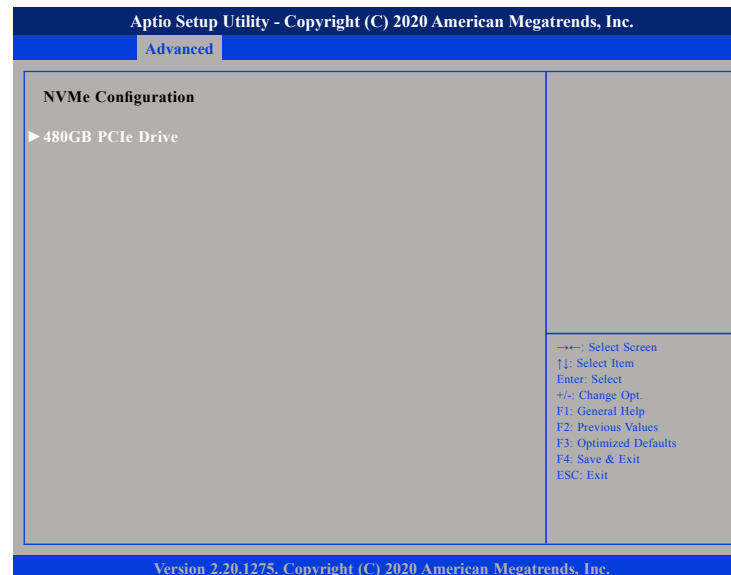

### NVMe Device (480GB PCIe Drive)

Enters the submenu of the NVMe device.

## NVMe Device (480GB PCIe Drive)

Aptio Setup Utility - Copyright (C) 2020 American Megatrends, Inc.		
Advanced		
Seg:Bus:Dev:Func	00:04:00:00	Select either Short or Extended Self Test. Short option will take couple of minutes and extended option will take several minutes to complete.
Model Number	480GB PCIe Drive	
Total Size	480.1 GB	
Vendor ID	1BCD	
Device ID	5008	
Namespace: 1	Size: 480.1 GB	
<b>Device Self Test:</b>		
Self Test Option	[Short]	
Self Test Action	[Controller Only Test]	
Run Device Self Test		
Short Device Selftest Result	[Not Available]	--> Select Screen ↑↓ Select Item Enter: Select +/- Change Opt. F1: General Help F2: Previous Values F3: Optimized Defaults F4: Save & Exit ESC: Exit
Extended Device Selftest Result	[Not Available]	
Version 2.20.1275. Copyright (C) 2020 American Megatrends, Inc.		

## Run Device Self Test

Run the device self test according to the self test option and action selected. Pressing the Esc key will abort the test.

## Self Test Option

Configures the method used for self test.

Short                Short option will take couple of minutes to complete.  
 Extended            Extended option will take several minutes to complete.

## Self Test Action

Configures the items used for self test. Controller Only Test and Controller and NameSpace Test options are available. Selecting Controller and NameSpace Test will take longer to complete.

## Network Stack Configuration

This section is used to configure the network stack.

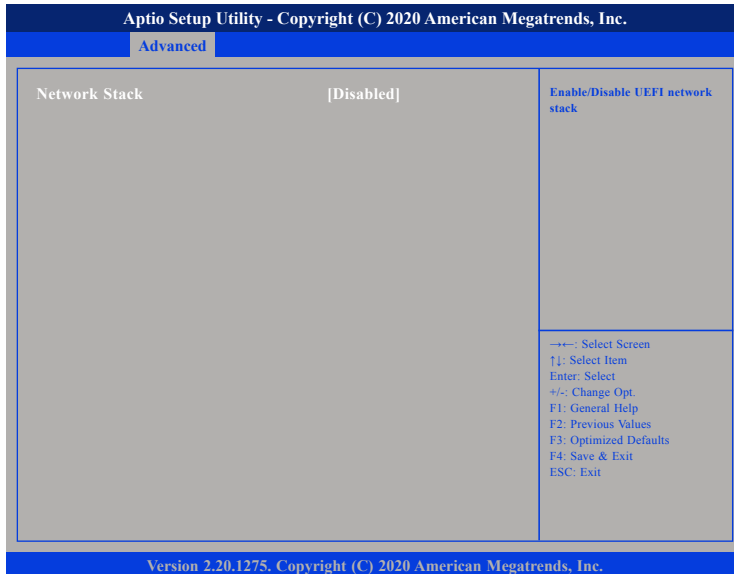

### Network Stack

Enables or disables UEFI network stack.

## Chipset

This section gives you functions to configure the system based on the specific features of the chipset. The chipset manages bus speeds and access to system memory resources.

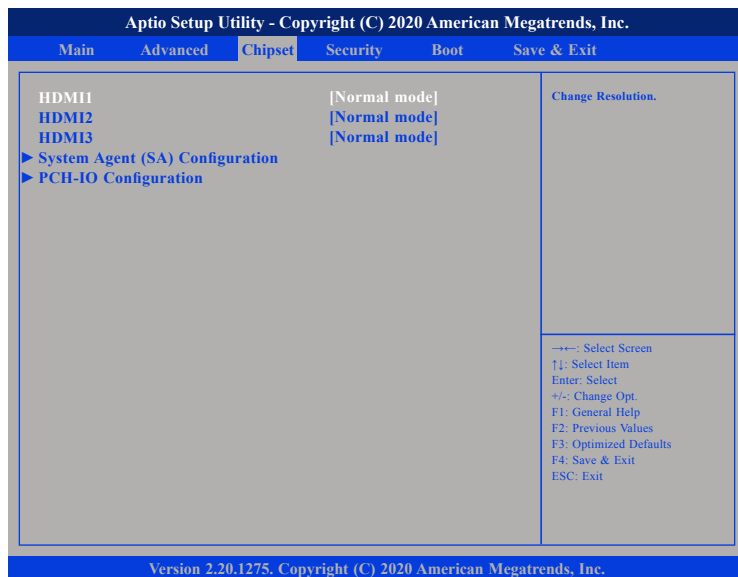

### System Agent (SA) Configuration

System Agent (SA) parameters.

### PCH-IO Configuration

PCH-IO parameters.

## System Agent (SA) Configuration

This section is used to configure the System Agent (SA) configuration.



### Graphics Configuration

Enters the Graphics Configuration submenu.

### PEG Port Configuration

Enters the PEG Port Configuration submenu.

### VT-d

Enables or disables VT-d function on MCH.

## Graphics Configuration

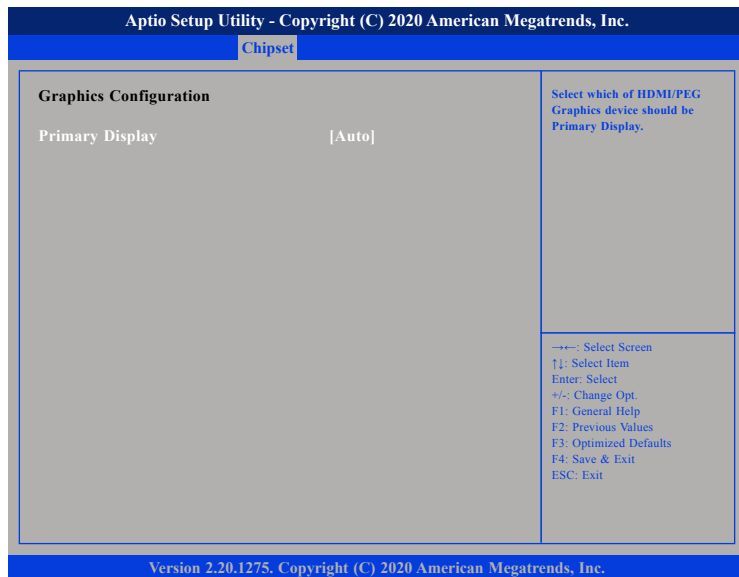

### Primary Display

Select which HDMI/PEG graphics device should be the primary display.

## PEG Port Configuration



### Enable Root Port

Enables or disables the root port.

### Max Link Speed

Configures the maximum link speed of the PEG device.

## PCH-IO Configuration

This section is used to configure PCH-IO configuration.



### USB Power State in S5

Configures the USB power state in S5.

### State After G3

Configures the power state when power is re-applied after a power failure (G3 state).

## SATA And RST Configuration

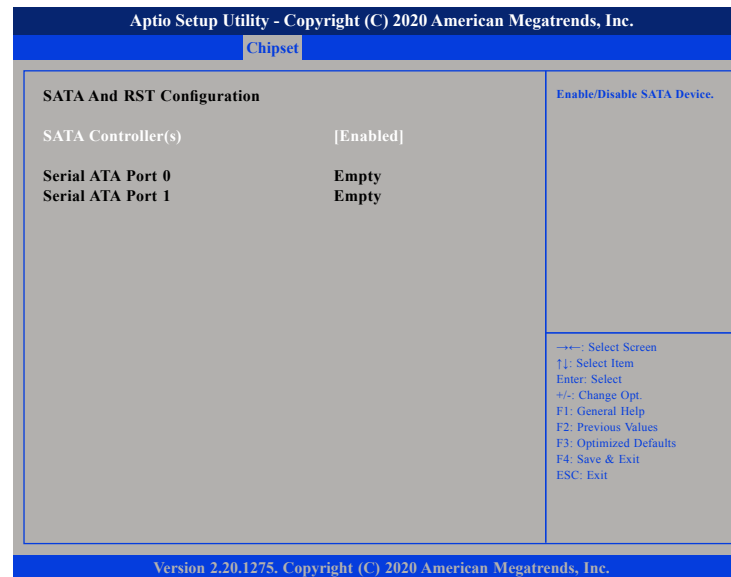

### SATA Controller(s)

Enables or disables SATA device.

## HD Audio Configuration



### HD Audio

Control detection of the HD audio device.

Disabled HD audio will be unconditionally disabled.  
 Enabled HD audio will be unconditionally enabled.

## Security

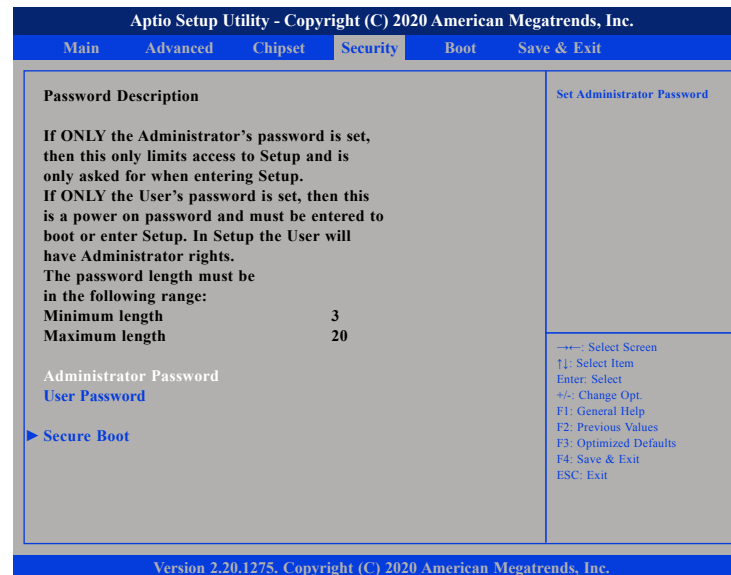

### Administrator Password

Select this to reconfigure the administrator's password.

### User Password

Select this to reconfigure the user's password.



## Secure Boot



### Secure Boot

Select this to enable or disable Secure Boot. Secure Boot only works when the system runs in user mode.

### Secure Boot Mode

Select this to configure the Secure Boot mode.

Standard	Fixed secure boot policy.
Custom	Secure boot policy variables can be configured by a physically present user without full authentication.

## Key Management

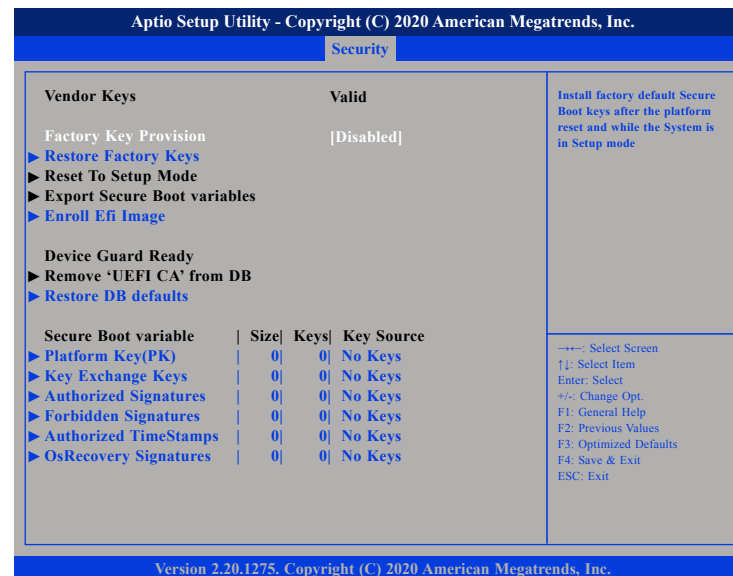

### Factory Key Provision

Select this to enable or disable the installation of factory default secure boot keys after the platform resets during system setup mode.

## Boot



### Setup Prompt Timeout

Selects the number of seconds to wait for the setup activation key. 65535(0xFFFF) denotes indefinite waiting.

### Bootup NumLock State

This allows you to determine the default state of the numeric keypad. By default, the system boots up with NumLock on wherein the function of the numeric keypad is the number keys. When set to Off, the function of the numeric keypad is the arrow keys.

### Boot Option Priorities

Adjust the boot sequence of the system. Boot Option #1 is the first boot device that the system will boot from, next will be #2 and so forth.

## Save & Exit

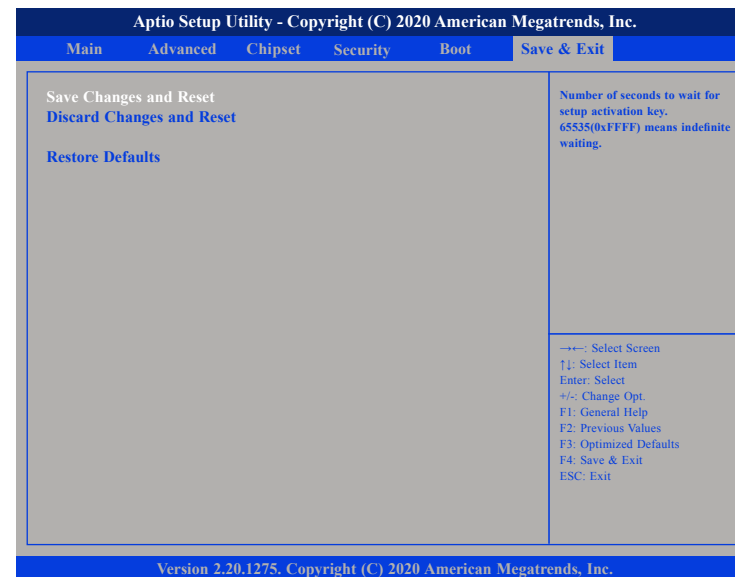

### Save Changes and Reset

To save the changes and reset, select this field then press <Enter>. A dialog box will appear. Confirm by selecting Yes.

### Discard Changes and Reset

To exit the Setup utility and reset without saving the changes, select this field then press <Enter>. You may be prompted to confirm again before exiting.

### Restore Defaults

To restore the BIOS to default settings, select this field then press <Enter>. A dialog box will appear. Confirm by selecting Yes.