

EDS-G205-1GTXSFP Series Quick Installation Guide

Moxa EtherDevice Switch

Version 3.1, January 2021

Technical Support Contact Information
www.moxa.com/support

MOXA[®]

© 2021 Moxa Inc. All rights reserved.

P/N: 1802002051033



Overview

The EDS-G205-1GTXSFP switches are equipped with 5 Gigabit Ethernet ports (4 10/100/1000BaseT(X) ports and 1 combo 10/100/1000BaseT(X) or 100/1000BaseSFP port), making them ideal, economical solutions for demanding, high bandwidth Gigabit Ethernet applications. In addition, the built-in relay warning function alerts system administrators when power failures or port breaks occur, and the add-on 4-pin DIP switches can be used to configure broadcast storm protection, jumbo frame rate, IEEE 802.3az energy saving, and 100/1000 SFP speed switching. The EDS-G205-1GTXSFP series includes 2 models: one with an operating temperature range of -10 to 60°C, and the other with an extended operating temperature range of -40 to 75°C. These 2 models have passed a 100% burn-in test to ensure that they fulfill the special needs of industrial automation control. The EDS-G205-1GTXSFP series can be easily installed on a DIN rail or in distribution boxes.

NOTE Throughout this Hardware Installation Guide, we use EDS as an abbreviation for Moxa EtherDevice Switch:

EDS = Moxa EtherDevice Switch

Package Checklist

The EDS-G205-1GTXSFP is shipped with the following items.

- Moxa EDS-G205-1GTXSFP Switch
- Quick installation guide (printed)
- Warranty card

Note: Please contact your customer service representative for assistance if any of these items are missing or damaged.

Features

High Performance Network Switching Technology

- 10/100/1000BaseT(X) (RJ45), auto negotiation speed, F/H duplex mode
- IEEE 802.3/802.3u/802.3ab/802.3z
- 100BaseSFP/1000BaseSFP; easily configure speed by DIP switch
- Store and Forward switching process type, 8K MAC address entries.

Industrial Grade Reliability and Efficiency

- Power failure, port break alarm by relay output
- Redundant dual 12/24/48 VDC power inputs
- IEEE 802.3az energy-efficient Ethernet settings by DIP switch
- Jumbo frame setting by DIP switch

Rugged Design

- Operating temperature range of -10 to 60°C, or extended operating temperature of -40 to 75°C for T models
- IP30, rugged high-strength housing
- DIN rail or panel mounting capability

Panel Layout of the EDS-G205-1GTXSFP

Front Panel View

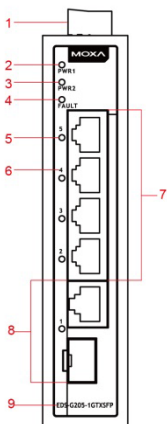

1. Terminal block for power input (PWR1, PWR2) and relay output
2. PWR1: LED for power input 1
3. PWR2: LED for power input 2
4. FAULT: LED indicator
5. 10/100/1000BaseT(X) LED indicator (Amber: 10/100M; Green: 1000M)
6. Port number
7. 2 to 5: 10/100/1000 BaseT(X) ports
8. 1: 10/100/1000 BaseT(X) or 100/1000Base SFP slot combo port
9. Model Name
10. Grounding screw
11. DIP switches
12. Screw hole for wall mounting kit
13. DIN rail kit

Top Panel View

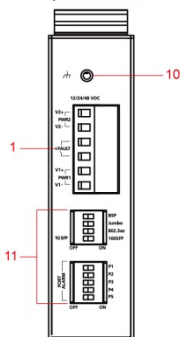

Rear Panel View

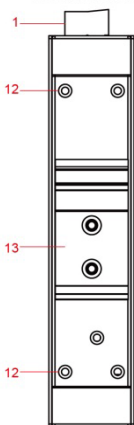

Mounting Dimensions, unit = mm (inch)

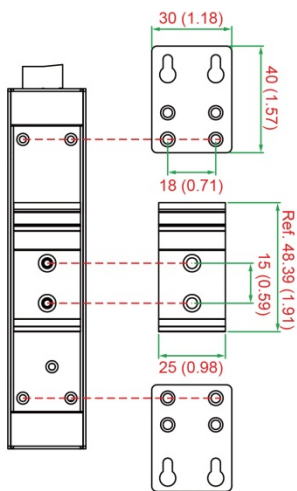
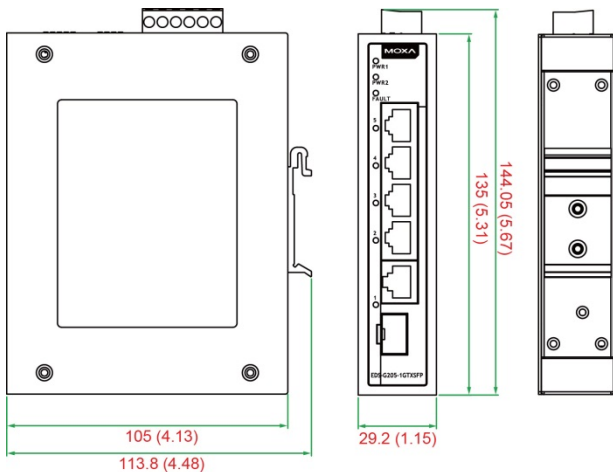

DIN Rail Mounting

The aluminum DIN rail attachment plate should already be fixed to the back panel of the switch when you take it out of the box. If you need to reattach the DIN rail attachment plate, make sure the stiff metal spring is situated towards the top, as shown in the figures below.

STEP 1:

Insert the top of the DIN rail into the slot just below the stiff metal spring.

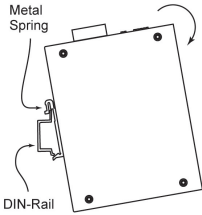
**STEP 2:**

The DIN rail attachment unit will snap into place as shown below.

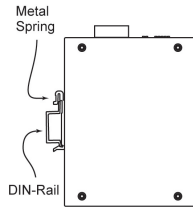

To remove the DIN rail from the switch, simply reverse Steps 1 and 2.

Wall Mounting (optional)

For some applications, you will find it convenient to mount the switch on the wall, as illustrated below.

STEP 1:

Remove the aluminum DIN rail attachment plate from the switch's rear panel, and then attach the wall mount plates, as shown in the figure.

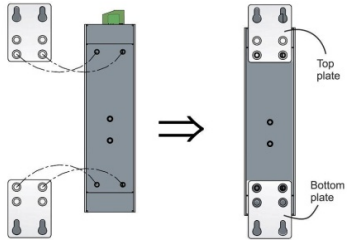
**STEP 2:**

Mounting the switch on the wall requires 4 screws. Use the switch, with wall mount plates attached, as a guide to mark the correct locations of the 4 screws. The heads of the screws should be less than 6.0 mm in diameter, and the shafts should be less than 3.5 mm in diameter, as shown in the figure at the right.

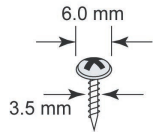

NOTE Before tightening the screws into the wall, make sure the screw head and shank size are suitable by inserting the screw into one of the keyhole-shaped apertures of the wall mounting plates.

Do not screw the screws in all the way—leave about 2 mm to allow room for sliding the wall mount panel between the wall and the screws.

STEP 3:

Once the screws are fixed in the wall, insert the four screw heads through the large parts of the keyhole-shaped apertures, and then slide the switch downwards, as indicated. Tighten the four screws for added stability.

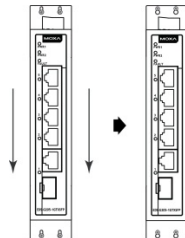

Wiring Requirements



WARNING

Safety First!

Turn the power off before disconnecting modules or wires. The proper power supply voltage is listed on the product label. Check the voltage of your power source to make sure you are using the correct voltage. Do NOT use a voltage greater than what is specified on the product label.

These devices must be supplied by an AELV source as defined in the Low Voltage Directive 2006/95/EC and 2004/108/EC.



WARNING

Safety First!

Calculate the maximum possible current in each power wire and common wire. Observe all electrical codes dictating the maximum current allowable for each wire size.

If the current goes above the maximum ratings, the wiring could overheat, causing serious damage to your equipment.

You should also pay attention to the following items:

- Use separate paths to route wiring for power and devices. If power wiring and device wiring paths must cross, make sure the wires are perpendicular at the intersection point.
NOTE: Do not run signal or communications wiring and power wiring in the same wire conduit. To avoid interference, wires with different signal characteristics should be routed separately.
- You can use the type of signal transmitted through a wire to determine which wires should be kept separate. The rule of thumb is that wiring with similar electrical characteristics can be bundled together.
- Keep input wiring and output wiring separated.
- We strongly advise labeling the wiring for all devices in the system.

Grounding Your Moxa Switch

Grounding and wire routing help limit the effects of noise due to electromagnetic interference (EMI). Run the ground connection from the ground screw to the grounding surface prior to connecting devices. The cross sectional area of the ground wires should be at least 3.31 mm².



ATTENTION

This product is intended to be mounted to a well-grounded mounting surface, such as a metal panel.

Wiring the Alarm Contact

The alarm contact consists of the two middle contacts of the terminal block on the switch's top panel. You may refer to the next section for detailed instructions on how to connect the wires to the terminal block connector, and how to attach the terminal block connector to the terminal block receptor.

In this section, we explain the meaning of the two contacts used to connect the alarm contact.

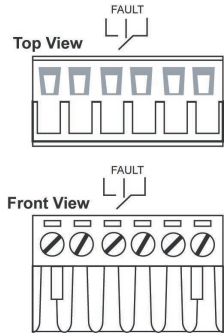

FAULT: The two middle contacts of the 6-contact terminal block connector are used to detect both power faults and port faults. The two wires attached to the Fault contacts form an open circuit when:

1. The switch has lost power from one of the DC power inputs.
OR
2. The PORT ALARM DIP switch for one of the ports is set to ON, but the port is not connected properly.

If neither of these two conditions is satisfied, the Fault circuit will be closed.

Wiring the Redundant Power Inputs

The top two contacts and the bottom two contacts of the 6-contact terminal block connector on the switch's top panel are used for DC inputs. Top and front views of one of the terminal block connectors are shown here.

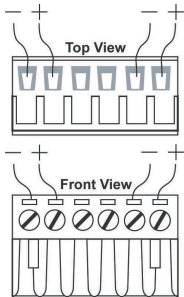

STEP 1: Insert the negative/positive DC wires into the V-/V+ terminals.

STEP 2: To keep the DC wires from pulling loose, use a small flat-blade screwdriver to tighten the wire-clamp screws on the front of the terminal block connector.

STEP 3: Insert the plastic terminal block connector prongs into the terminal block receptor, which is located on switch's top panel.



ATTENTION

Before connecting the switch to the DC power inputs, make sure the DC power source voltage is stable.

You should also pay attention to the following:

- The terminal block plug must be suitable for 28-12 AWG (0.0804 to 3.31 mm²) wiring; use a torque value of 4.5 lb-in.
- Conductors suitable for use in an ambient temperature of 84°C must be used for the power input terminal block.
- Only use one individual conductor at each clamping point.

Communication Connections

EDS-G205-1GTXSFP switches have 2 types of communication port:

- 4 10/100/1000BaseT(X) Ethernet ports
- 1 combination 10/100/1000T(X) or 100/1000BaseSFP port

10/100/1000BaseT(X) Ethernet Port Connection

The 10/100/1000BaseT(X) ports located on switch's front panel are used to connect to Ethernet-enabled devices. Most users will choose to configure these ports for Auto MDI/MDI-X mode, in which case the port's pinouts are adjusted automatically depending on the type of Ethernet cable used (straight-through or cross-over), and the type of device (NIC-type or HUB/Switch-type) connected to the port.

In what follows, we give pinouts for both MDI (NIC-type) ports and MDI-X (HUB/Switch-type) ports. We also give cable wiring diagrams for straight-through and cross-over Ethernet cables.

10/100BaseT(x) RJ45 Pinouts

MDI Port Pinouts

Pin	Signal
1	Tx+
2	Tx-
3	Rx+
6	Rx-

MDI-X Port Pinouts

Pin	Signal
1	Rx+
2	Rx-
3	Tx+
6	Tx-

8-pin RJ45

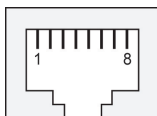

1000BaseT RJ45 Pinouts

Pin	MDI	MDI-X
1	BI_DA+	BI_DB+
2	BI_DA-	BI_DB-
3	BI_DB+	BI_DA+
4	BI_DC+	BI_DD+
5	BI_DC-	BI_DD-
6	BI_DB-	BI_DA-
7	BI_DD+	BI_DC+
8	BI_DD-	BI_DC-

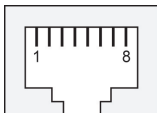

RJ45 (8-pin) to RJ45 (8-pin) Straight-Through Cable Wiring

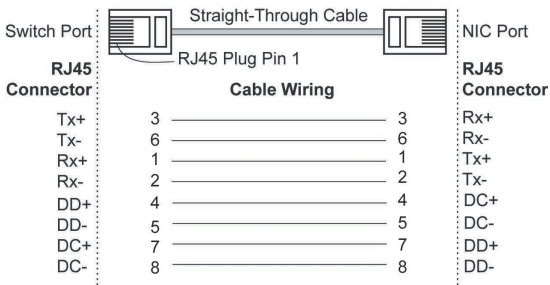

RJ45 (8-pin) to RJ45 (8-pin) Cross-Over Cable Wiring

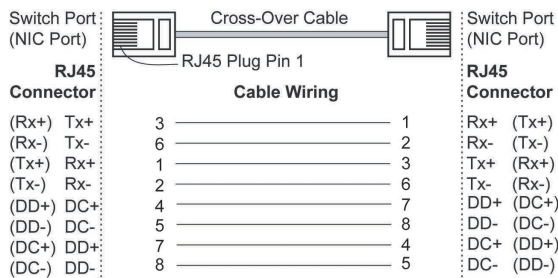

100/1000BaseSFP (mini-GBIC) Fiber Port

One of the Gigabit Ethernet ports on the EDS-G205-1GTXSFP is an SFP slot, which requires 100M or 1G mini-GBIC fiber transceivers to work properly. Moxa provides complete transceiver models for various distance requirements.

The concept behind the LC port and cable is straightforward. Suppose you are connecting devices I and II. Unlike electrical signals, optical signals do not require a circuit in order to transmit data. Consequently, one of the optical lines is used to transmit data from device I to device II, and the other optical line is used to transmit data from device II to device I, for full-duplex transmission.

Remember to connect the Tx (transmit) port of device I to the Rx (receive) port of device II, and the Rx (receive) port of device I to the Tx (transmit) port of device II. If you make your own cable, we suggest labeling the two sides of the same line with the same letter (A-to-A and B-to-B, as shown below, or A1-to-A2 and B1-to-B2).

LC-Port Pinouts

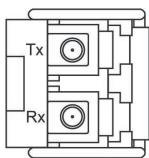

LC-Port to LC-Port Cable Wiring

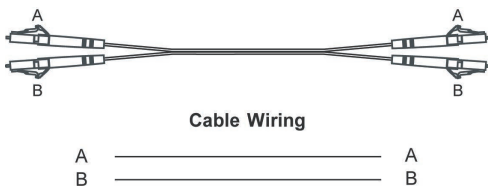

ATTENTION

This is a Class 1 Laser/LED product. To avoid causing serious damage to your eyes, do not stare directly into the laser beam.

Redundant Power Inputs

Both power inputs can be connected simultaneously to live DC power sources. If one power source fails, the other live source acts as a backup, and automatically supplies all of the switch's power needs.

Alarm Contact

The EDS-G205-1GTXSFP has one alarm contact located on the top panel. For detailed instructions on how to connect the alarm contact power wires to the two middle contacts of the 6-contact terminal block connector, see the **Wiring the Alarm Contact** section on page 7. A typical scenario would be to connect the Fault circuit to a warning light located in the control room. The light can be set up to switch on when a fault is detected.

The alarm contact has two terminals that form a Fault circuit for connecting to an alarm system. The two wires attached to the Fault contacts form an open circuit when (1) the switch has lost power from one of the DC power inputs, or (2) one of the ports, for which the corresponding PORT ALARM DIP switch is set to ON, is not properly connected.

If neither of these two conditions occurs, the Fault circuit will be closed.

DIP Switch Settings

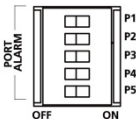
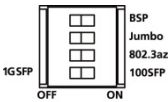

The default setting for each DIP switch is OFF. The following table explains the effect of setting the DIP switches to the ON positions.

DIP Switch	Setting	Description
BSP	ON	Enables broadcast storm protection
	OFF	Disables broadcast storm protection
Jumbo Frame	ON	Enables jumbo frame function
	OFF	Disables jumbo frame function
802.3az	ON	Enables the energy-efficient Ethernet function
	OFF	Disables the energy-efficient Ethernet function
100/1000BaseSFP	ON	Supports 100M SFP module
	OFF	Supports 1000M SFP module
Port Alarm	ON	Enables the corresponding PORT Alarm. If the port's link fails, the relay will form an open circuit and the fault LED will light up
	OFF	Disables the corresponding PORT Alarm. If the port's link fails, the relay will form a closed circuit and the fault LED will never light up



ATTENTION

To actively update DIP switch settings, power off and then power on the switch.

LED Indicators

The front panel of the EDS-G205-1GTXSFP switch contains several LED indicators. The function of each LED is described in the table below.

LED	Color	State	Description
PWR1	AMBER	On	Power is being supplied to power input PWR1
		Off	Power is not being supplied to power input PWR1
PWR2	AMBER	On	Power is being supplied to power input PWR2
		Off	Power is not being supplied to power input PWR2
FAULT	RED	On	When the corresponding PORT alarm is enabled, and the port's link is inactive.
		Off	When the corresponding PORT alarm is enabled and the port's link is active, or when the corresponding PORT alarm is disabled.
10/100/ 1000M	AMBER	On	TP port's 10/100 Mbps or SFP port's 100 Mbps link is active.
		Blinking	Data is being transmitted at 10/100 Mbps
		Off	TP port's 10/100 Mbps or SFP port 100 Mbps link is inactive.
	GREEN	On	TP/SFP port's 1000 Mbps link is active.
		Blinking	Data is being transmitted at 1000 Mbps
		Off	TP/SFP port's 1000 Mbps link is inactive

Auto MDI/MDI-X Connection

The Auto MDI/MDI-X function allows users to connect the switch's 10/100/1000BaseT(X) ports to any kind of Ethernet device, without paying attention to the type of Ethernet cable being used for the connection. This means that you can use either a straight-through cable or cross-over cable to connect the switch to Ethernet devices.

Three Speed Functionality and Switching

The switch's 10/100/1000 Mbps RJ45 switched port auto negotiates with the connected device for the fastest data transmission rate supported by both devices. The switch is a plug-and-play device, so software configuration is not required at installation or during maintenance.

The half/full duplex mode for the RJ45 switched ports is user dependent and changes (by auto-negotiation) to full or half duplex, depending on which transmission speed is supported by the attached device.

Auto-Negotiation and Speed Sensing

The switch's RJ45 Ethernet ports independently support auto-negotiation for transmission speeds of 10 Mbps, 100 Mbps, and 1000 Mbps, with operation according to the IEEE 802.3 standard.

This means that some nodes could be operating at 10 Mbps, while at the same time, other nodes are operating at 100 Mbps or 1000 Mbps.

Auto-negotiation takes place when an RJ45 cable connection is made, and then each time a LINK is enabled. The switch advertises its capability for using 10 Mbps, 100 Mbps, or 1000 Mbps transmission speeds, with the device at the other end of the cable expected to advertise similarly. Depending on what type of device is connected, this will result in agreement to operate at a speed of 10 Mbps, 100 Mbps, or 1000 Mbps.

If the switch's RJ45 Ethernet port is connected to a non-negotiating device, it will default to 10 Mbps speed and half-duplex mode, as required by the IEEE 802.3 standard.

ATEX Information

1. Certificate number:
ATEX:DEMKO 14 ATEX 1443X
2. Ambient range:
-40°C ≤ T_{amb} ≤ +75°C for Models with suffix of "-T";
-10°C ≤ T_{amb} ≤ +60°C for Models without suffix of "-T".
3. Certification string:
ATEX: ε II 3G Ex nA nC IIC T4 Gc
4. Standards covered:
EN 60079-0:2012+A11:2013/IEC 60079-0:2011 Ed.6
EN 60079-15:2010/IEC 60079-15:2010 Ed.4
5. Conditions of safe usage:
 - a. The equipment shall only be used in an area of not more than pollution degree 2, as defined in IEC 60664-1.
 - b. The equipment shall be installed in an enclosure that provides a degree of protection not less than IP54 in accordance with EN 60079-15 and accessible only by the use of a tool.
 - c. When end users use Optical SFP Communications modules, the modules must be limited to Laser Class 1 only.



II 3G



Specifications

Technology	
Standards	IEEE 802.3 for 10BaseT IEEE 802.3u for 100BaseT(X) and 100BaseFX IEEE 802.3ab for 1000BaseT(X) IEEE 802.3z for 1000BaseX IEEE 802.3x for Flow Control IEEE 802.3az for Energy-Efficient Ethernet
Interface	
RJ45 Ports	10/100/1000BaseT(X) auto negotiation speed, half/full duplex mode, and auto MDI/MDI-X connection
Fiber Ports	Optional 1000BaseSX/LX/LHX/ZX (LC connector) or 100BaseSFP
LED Indicators	PWR1, PWR2, FAULT, 10/100M/1000M
DIP Switch	Port break alarm, broadcast storm protection, jumbo frame, IEEE 802.3az, 10/1000BaseSFP
Alarm Contact	One relay output with current carrying capacity of 1A @ 24 VDC; resistance Class 2.

Power Requirements	
Input Voltage	12/24/48 VDC, redundant inputs, Class 2
Input Current	0.16 A @ 24 VDC
Connection	One removable 6-pin terminal block
Overload Current Protection	Present
Reverse Polarity Protection	Present
Physical Characteristics	
Housing	IP30 protection, metal case
Dimensions	29 x 135 x 105 mm (1.14 x 5.31 x 4.13 in)
Weight	290 g
Installation	DIN rail, wall mounting (optional kit)
Environmental Limits	
Operating Temperature	-10 to 60°C (14 to 140°F) -40 to 75°C (-40 to 167°F) for -T models
Storage Temperature	-40 to 85°C (-40 to 185°F)
Ambient Relative Humidity	5 to 95% (non-condensing)
Regulatory Approvals	
Safety	UL 508
Hazardous Location	UL/cUL Class I, Division 2, Groups A, B, C, and D; ATEX Zone 2, Ex nA nC IIC T4 Gc
EMI	FCC Part 15, CISPR (EN 55032) Class A
EMS	EN 61000-4-2 (ESD), Level 3 EN 61000-4-3 (RS), Level 3 EN 61000-4-4 (EFT), Level 3 EN 61000-4-5 (Surge), Level 3 EN 61000-4-6 (CS), Level 3 EN 61000-4-8
Rail Traffic	EN 50121-4
Shock	IEC 60068-2-27
Freefall	IEC 60068-2-32
Vibration	IEC 60068-2-6
Warranty	
Warranty Period	5 years
Details	See www.moxa.com/warranty