

VP-X201-CE7 Series

User Manual

Version 1.0.1 December 2017

Service and usage information for



VP-2201-CE7
VP-3201-CE7
VP-4201-CE7
VP-5201-CE7
VP-6201-CE7

Written by TungLu Do
Edited by Anna Huang

Warranty

All products manufactured by ICP DAS are under warranty regarding defective materials for a period of one year, beginning from the date of delivery to the original purchaser.

Warning

ICP DAS assumes no liability for any damage resulting from the use of this product. ICP DAS reserves the right to change this manual at any time without notice. The information furnished by ICP DAS is believed to be accurate and reliable. However, no responsibility is assumed by ICP DAS for its use, not for any infringements of patents or other rights of third parties resulting from its use.

Copyright

Copyright © 2017 by ICP DAS Co., Ltd. All rights are reserved.

Trademark

The names used for identification only may be registered trademarks of their respective companies.

Contact US

If you have any problem, please feel free to contact us.

You can count on us for quick response.

Email: service@icpdas.com

Contents

CONTENTS	3
1. INTRODUCTION	6
1.1. Features.....	7
1.2. Specifications	8
1.3. Overview	10
1.3.1. Front View	10
1.3.2. Side View	12
1.3.3. Bottom View	14
1.4. Dimensions.....	17
1.5. Companion CD	20
2. GETTING STARTED	21
2.1. Mounting the VP-X201-CE7	22
2.2. Deploying a Basic VP-X201-CE7 System	25
2.3. Configuring the Boot Mode	26
2.4. Changing the User Interface Language	28
2.5. Using PAC Utility to Manage the VP-X201-CE7	30
3. TOOLS AND TASKS	31
3.1. PAC Utility.....	32
3.1.1. Menu Bar – File.....	33
3.1.2. Menu Bar – Help.....	34
3.1.3. Property Tab - General.....	35
3.1.4. Property Tab – Display	37
3.1.5. Property Tab – IP Config	38
3.1.6. Property Tab – Network	39
3.1.7. Property Tab – Device Information.....	42
3.1.8. Property Tab – Auto Execution	43
3.1.9. Property Tab – Rotary Execution	44
3.2. DCON Utility Pro.....	45
3.3. TaskMgr	46
3.4. VCEP	47
3.5. Remote_Display	48
3.6. SendToCOM.....	49
3.7. RegEdit	50
3.8. ISQLW35	51
3.9. INotepad.....	52

4.	YOUR FIRST VP-X201-CE7 PROGRAM	53
4.1.	Setting up the Development Environment	53
4.1.1.	Preparing the Development Tools and Programming Languages	54
4.1.2.	Installing the VP-X201-CE7 SDK.....	55
4.1.3.	Setting up the Global Compiler Settings (for Visual C++).....	56
4.2.	First VP-X201-CE7 Program in VB.NET	58
4.2.1.	Create a new project	59
4.2.2.	Specify the path of the PAC reference.....	62
4.2.3.	Add the control to the form	64
4.2.4.	Add the event handling for the control.....	66
4.2.5.	Upload the application to VP-X201-CE7.....	67
4.2.6.	Execute the application on VP-X201-CE7	69
4.3.	First VP-X201-CE7 Program in Visual C#.....	70
4.3.1.	Create a new project	71
4.3.2.	Specify the path of the PAC reference.....	74
4.3.3.	Add the control to the form	76
4.3.4.	Add the event handling for the control.....	78
4.3.5.	Upload the application to VP-X201-CE7.....	79
4.3.6.	Execute the application on VP-X201-CE7	81
4.4.	First VP-X201-CE7 Program in Visual C++.....	82
4.4.1.	Create a new project	83
4.4.2.	Configure the Platform	88
4.4.3.	Specify the Libraries of the PAC SDK.....	89
4.4.4.	Add the control to the form	91
4.4.5.	Add the event handling for the control.....	94
4.4.6.	Upload the application to VP-X201-CE7.....	96
4.4.7.	Execute the application on VP-X201-CE7	98
5.	I/O EXPANSION MODULES AND SDKS SELECTION	99
6.	API RESOURCES AND DEMO REFERENCES	102
6.1.	PAC Standard APIs for System Operation.....	103
6.1.1.	VB.NET Demos for PAC Standard APIs.....	104
6.1.2.	C# Demos for PAC Standard APIs.....	105
6.1.3.	Visual C++ Demos for PAC Standard APIs	106
6.2.	PAC Standard APIs for I/O Expansion	107
6.2.1.	VB.NET Samples for PAC Standard APIs.....	108
6.2.2.	C# Samples for PAC Standard APIs.....	109
6.2.3.	Visual C++ Samples for PAC Standard APIs.....	110

7. VP-X201-CE7 UPDATES	111
7.1. OS Updates.....	112
7.1.1. OS Updates from Eshell	113
7.1.2. OS updates using micro_SD.....	116
7.2. SDK Updates.....	119
7.2.1. SDK Updates for VB.NET or C#	120
7.2.2. SDK Updates for VB.NET or Visual C++	121
8. VIEWPAC DOWNLOAD CENTER	122
TIPS & HOW TO	123
A. How to Online Debug the VP-X201-CE7 Program	124
B. How to Automatically Synchronize VP-X201-CE7 Clock with an Internet Time Server	129
C. How to Control the User Account Control in VP-X201-CE7	131
C.1. How to Create a User Account.....	132
C.2. How to Use Telnet to Remote Login the ViewPAC from PC	134
C.3. How to Remove a User Account from the Login List	136
D. How to Use the Services Tool	137
E. How to Set DIP Switch for COM Port Communication	139
F. Revision History	143

1. Introduction

This chapter provides an overview of the VP-X201-CE7 and its components, and introduces the fundamental concepts for user familiar with the VP-X201-CE7.



The VP-X201-CE7 is the new generation Windows CE 7.0 based PAC (Programmable Automation Controller) of ICP DAS. Each VP-X201-CE7 is equipped with a Cortex-A8 (1.0 GHz) CPU running a Windows CE 7.0 operating system, and a variant of input/output ports (USB, Ethernet, RS-232/485).

Its operating system, Windows CE 7.0, has many advantages, including hard real-time capability, small core size, fast boot speed, and interrupt handling at a deeper level, achievable deterministic control and low cost. Using Windows CE 7.0 in the VP-X201-CE7 gives it the ability to run PC-based Control software such as Visual Basic.NET, Visual C#, SCADA software, Soft PLC ...etc.

1.1. Features

The VP-X201-CE7 offers the most comprehensive configuration to meet specific application requirements. The following list shows the hardware and software features designed to simplify installation, configuration and application.

Hardware Features

- Powerful CPU module
- Cortex-A8 1.0 GHz CPU
- Memory Size:
 - SDRAM (512 MB)
 - MRAM (128 KB)
 - Flash (256 MB)
 - microSD/SD card (support up to 32 GB)
- USB 2.0 port x 2, Serial port (RS-232/RS-485) x 2/3, Ethernet port *1
- 64-bit Hardware Serial Number
- Dual Watchdog Timers
- Operating Temperature: -10 ~ +60 °C

Software Features

- Windows Embedded Compact 7.0
- JavaScript and VBScript
- SQL Compact Edition 3.5
- .NET Compact Framework 3.5
- Remote Display
- Rich Software Solution – SDK for Microsoft Studio 2008

1.2. Specifications

The table below summarizes the specifications of the VP-X201-CE7.

Models		VP-2201-CE7	VP-3201-CE7	VP-4201-CE7	VP-5201-CE7	VP-6201-CE7
LCD						
Diagonal Size		7" (16 : 9)	8.4" (4 : 3)	10.4" (4 : 3)	12.1" (4 : 3)	15" (4 : 3)
Resolution		800 x 480	800 x 600			1024 x 768
Brightness (cd/m2)		400				
Contrast Ratio		500 : 1				
LED Backlight Life (hrs)		20,000	50,000			
Touch Panel	Type	4-wire, resistive type	5-wire, resistive type			
	Light Transmission	80 %				
LED Indicator		2 (Run, PWR)				
System Software						
OS		Microsoft Windows Embedded Compact 7				
Framework Support		.NET Compact Framework 3.5				
Embedded Service		FTP Server, Web Server (Supports VB script, JAVA script), Embedded SQL Server				
SDK Provided		DII for Visual Studio.Net				
Multilanguage Support		English, German, French, Spanish, Russian, Italian, Korean, Simplified Chinese, Traditional Chinese				
CPU Module						
CPU		Cortex-A8 (1.0 GHz)				
SDRAM		512 MB (DDR3)				
MRAM		128 KB				
Flash (SSD)		256 MB				
EEPROM		16 KB				
Memory Expansion		micorSD socket (support up to 32 GB)	SD socket (support up to 32 GB)			
RTC (Real Time Clock)		Provide second, minute, hour, date, day of week, month, year				
64-bit Hardware Serial Number		Yes, for software copy protection				
Dual Watchdog Timers		0.8 second				
LED Indicator		2 LED indicators (PWR and RUN)				
Rotary Switch		0 to 9				



Models	VP-2201-CE7	VP-3201-CE7	VP-4201-CE7	VP-5201-CE7	VP-6201-CE7
--------	-------------	-------------	-------------	-------------	-------------

VGA & Communication Ports					
Ethernet	RJ-45 x 1, 10/100/1000 Base-TX				
USB	USB 2.0 x 2				
COM 1	RS-232/RS-485 ; 2500 VDC isolated	-	RS-232/RS-485 (DB9 connector); 2500 VDC isolated		
COM 2	RS-232/RS-485; 2500 V _{DC} isolated				
COM 3	-	RS-485; 2500 VDC isolated			
Audio	Earphone-out				
Mechanical					
Dimensions (W x H x D), unit: mm	213 x 148 x 44	249 x 207 x 64	291 x 229 x 54	323 x 254 x 64	381 x 305 x 63
Panel Cut-Out (W x H), unit: mm	197 x 133, ± 1	235 x 193, ± 1	277 x 215, ± 1	310 x 241, ± 1	362 x 286, ± 1
Installation	Panel Mounting, VESA (75 x 75) Mounting				
Ingress Protection	Front panel: NEMA 4/IP65				
Environmental					
Operating Temperature	-10 °C to +60 °C				
Storage Temperature	-20 °C to +70 °C				
Ambient Relative Humidity	10 % to 90 % RH (non-condensing)				
Power					
Input Range	+12 V _{DC} to +48 V _{DC}				
Power from PoE	IEEE 802.3af		IEEE 802.3at		
Isolation	-	1 kV			
Consumption	6 W	7.5 W	13 W	14 W	16 W

1.3. Overview

The VP-X201-CE7 is equipped with several interfaces and peripherals that can be integrated with external systems. Here is an overview of the components and its descriptions.

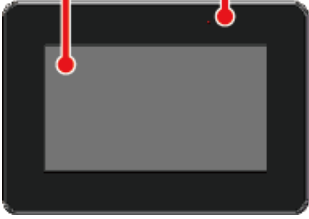
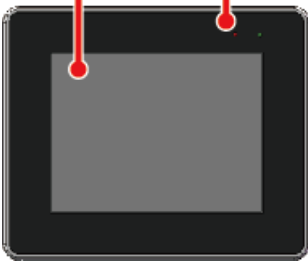
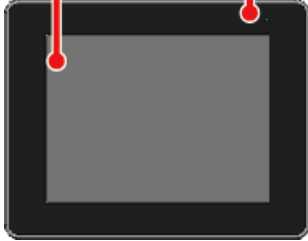
1.3.1. Front View

VP-2201-CE7	VP-3201-CE7	VP-4201-CE7
<p data-bbox="217 707 456 741">7" LCD Touch Panel</p> <p data-bbox="300 757 517 790">LED Indicator x 2</p> 	<p data-bbox="644 707 884 741">8.4" LCD Touch Panel</p> <p data-bbox="727 757 944 790">LED Indicator x 2</p> 	<p data-bbox="1075 696 1315 730">10" LCD Touch Panel</p> <p data-bbox="1158 745 1375 779">LED Indicator x 2</p> 
VP-5201-CE7	VP-6201-CE7	
<p data-bbox="217 1234 501 1267">12.1" LCD Touch Panel</p> <p data-bbox="300 1272 517 1305">LED Indicator x 2</p> 	<p data-bbox="655 1234 908 1267">15" LCD Touch Panel</p> <p data-bbox="727 1272 944 1305">LED Indicator x 2</p> 	

- **LED Indicators**

The VP-X201-CE7 has 2 LED indicators. The details of these LED indicators are as follows:





LED Indicator	Color	Status	Description
RUN	Green	On	System booted and ready.
	Green	Off	BIOS failure.
	Green	Blinking	System memory mapped out, formatted or defragmented.
PWR	Red	On	System has power applied to it.
	Red	Off	System is not powered on.

- **Touch Panel**

The VP-X201-CE7 is equipped with a touch panel to the display panel.

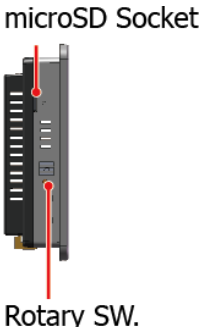
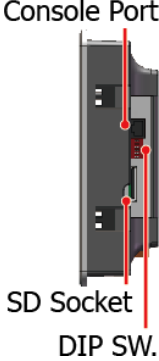
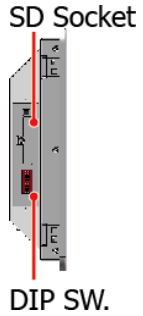
1.3.2. Side View

VP-2201-CE7	VP-3201-CE7	VP-4201-CE7
 <p>microSD Socket</p> <p>Rotary SW.</p>	 <p>Console Port</p> <p>SD Socket</p> <p>DIP SW.</p>	 <p>SD Socket</p> <p>DIP SW.</p>
VP-5201-CE7	VP-6201-CE7	
 <p>DIP Switch</p> <p>SD Socket</p>	 <p>DIP Switch</p> <p>SD Socket</p>	

- **microSD/SD Socket**

The microSD/SD socket can be used to restore the VP-X201-CE7 system and expand the memory up to 32 GB.

- **Rotary Switch**















Rotary Switch is an operating mode selector. The VP-X201-CE7 has several operating modes, for more detailed information about these operating modes. Please refer to “2.3 Configuring the Boot Mode”

- **Console Port**

The console port is unavailable.

● **DIP Switch**

The COM1 and COM2 of the VP-x201-CE7 provide versatile communication types: RS-232 and RS-485. The DIP switch can be used to assign communication types, three kinds of communication type to each COM port. (Refer to page 139 for more information)

Position 1, 2	COM Port	Description
	COM1	RS-232 Mode: ON RS-485 Pull Mode: ON (Master, default)
		RS-232 Mode : OFF RS-485 Pull Mode : OFF (Slave)
		RS-485 Slave Terminal Resistance 120 (Ohm): ON
		RS-485 Slave Terminal Resistance 120 (Ohm): OFF (default)
Position 3, 4	COM Port	Description
	COM2	RS-232 Mode : ON RS-485 Pull Mode : ON (Master, default)
		RS-232 Mode : OFF RS-485 Pull Mode : OFF (Slave)
		RS-485 Slave Terminal Resistance 120 (Ohm): ON
		RS-485 Slave Terminal Resistance 120 (Ohm): OFF (default)
Position 5, 6	COM Port	Description
	COM3	RS-485 Pull Mode : ON (Master, default)
		RS-485 Pull Mode : OFF (Slave)
		RS-485 Slave Terminal Resistance 120 (Ohm):ON
		RS-485 Slave Terminal Resistance 120 (Ohm):OFF (default)

1.3.3. Bottom View

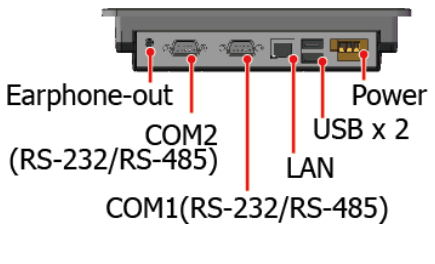
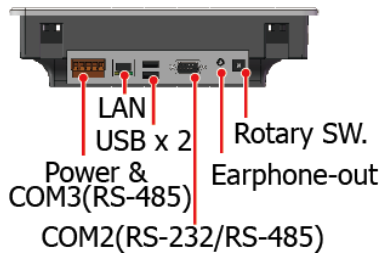
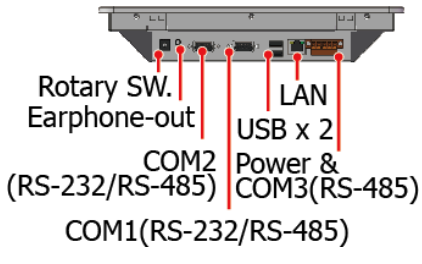
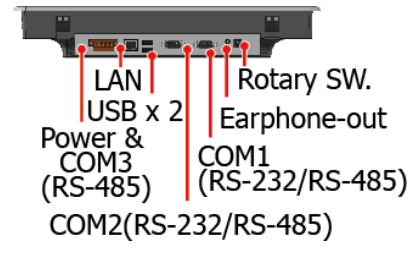
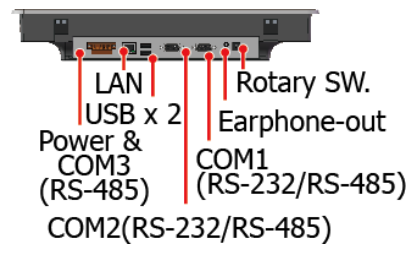
VP-2201-CE7	VP-3201-CE7	VP-4201-CE7
 <p>Earphone-out COM2 (RS-232/RS-485) COM1 (RS-232/RS-485) LAN USB x 2 Power</p>	 <p>LAN USB x 2 Power & COM3 (RS-485) COM2 (RS-232/RS-485) Rotary SW. Earphone-out</p>	 <p>Rotary SW. Earphone-out COM2 (RS-232/RS-485) COM1 (RS-232/RS-485) LAN USB x 2 Power & COM3 (RS-485)</p>
VP-5201-CE7	VP-6201-CE7	
 <p>LAN USB x 2 Power & COM3 (RS-485) COM2 (RS-232/RS-485) Rotary SW. Earphone-out COM1 (RS-232/RS-485)</p>	 <p>LAN USB x 2 Power & COM3 (RS-485) COM2 (RS-232/RS-485) Rotary SW. Earphone-out COM1 (RS-232/RS-485)</p>	

- **Earphone-out**

The VP-X201-CE7 has an earphone jack to output of sound system.

- **USB Port**

The VP-X201-CE7 has 2 USB 2.0 ports that can be used to connect the USB devices such as mouse, keyboard or an external USB hard drive.

- **LAN**

The VP-X201-CE7 has an Ethernet port that can be used to connect that can be used to connect the router to the Internet or to other devices, and can be powered by an IEEE802.3af compliant PoE switch. Both Ethernet and power can be carried by an Ethernet cable eliminating the need for additional wiring and power supply.

- **Power Input (PoE) and Frame Ground**

The VP-X201-CE7 has a terminal with 3 pins, there are 2 pins for power input and a pin for frame ground as follows:

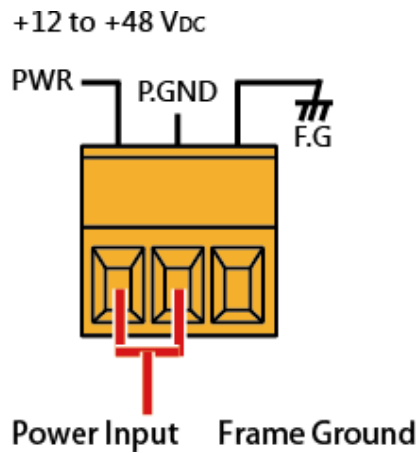

- **Rotary Switch**



Rotary Switch is an operating mode selector. The VP-X201-CE7 has several operating modes, for more detailed information about these operating modes. Please refer to “2.3 Configuring the Boot Mode”

- **COM1 (RS-232/RS-485)**

The COM1 port is a 9-pins RS-232/RS-485 connector. The details of the COM3 port specifications are shown to the side.

Note: 16C550 compatible

Port Type: Male

Baud Rate: 115200, 57600, 38400, 19200, 9600, 4800, 2400, 1200 bps

Data Bits: 5, 6, 7, 8

Parity: None, Even, Odd, Mark (Always 1), Space (Always 0)

Stop Bits: 1, 2

FIFO: 128 bytes

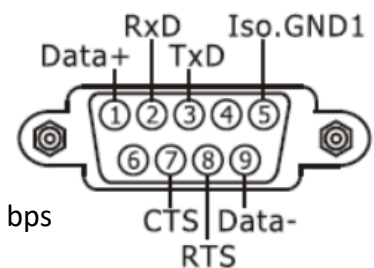

- **COM2 (RS-232/RS-485)**

The COM2 port is a 9-pins RS-232/RS-485 connector. The details of the COM3 port specifications are shown to the side.

Note: 16C550 compatible

Port Type: Male

Baud Rate: 115200, 57600, 38400, 19200, 9600, 4800, 2400, 1200 bps

Data Bits: 5, 6, 7, 8

Parity: None, Even, Odd, Mark (Always 1), Space (Always 0)

Stop Bits: 1, 2

FIFO: 128 bytes

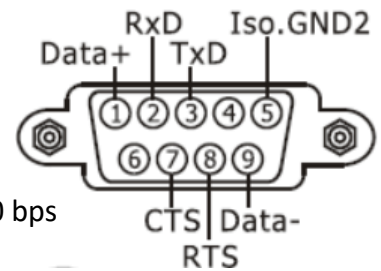

- **COM3**

COM3 port provides a connection to external RS-485 devices. The COM2 has 2 pins, as follows:

Baud Rate: 115200, 57600, 38400, 19200, 9600, 4800, 2400, 1200 bps

Data Bits: 7, 8

Parity: None, Even, Odd, Mark (Always 1), Space (Always 0)

Stop Bits: 1, 2

FIFO: 16 bytes

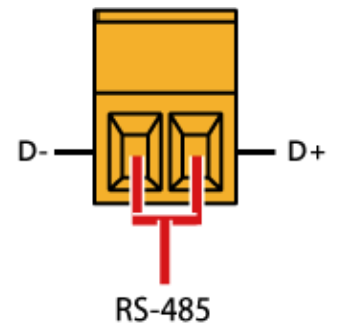

1.4. Dimensions

The diagrams below provide the dimensions of the VP-X201-CE7 to use in defining your enclosure specifications. Remember to leave room for potential expansion if you are using other components in your system.

VP-2201-CE7

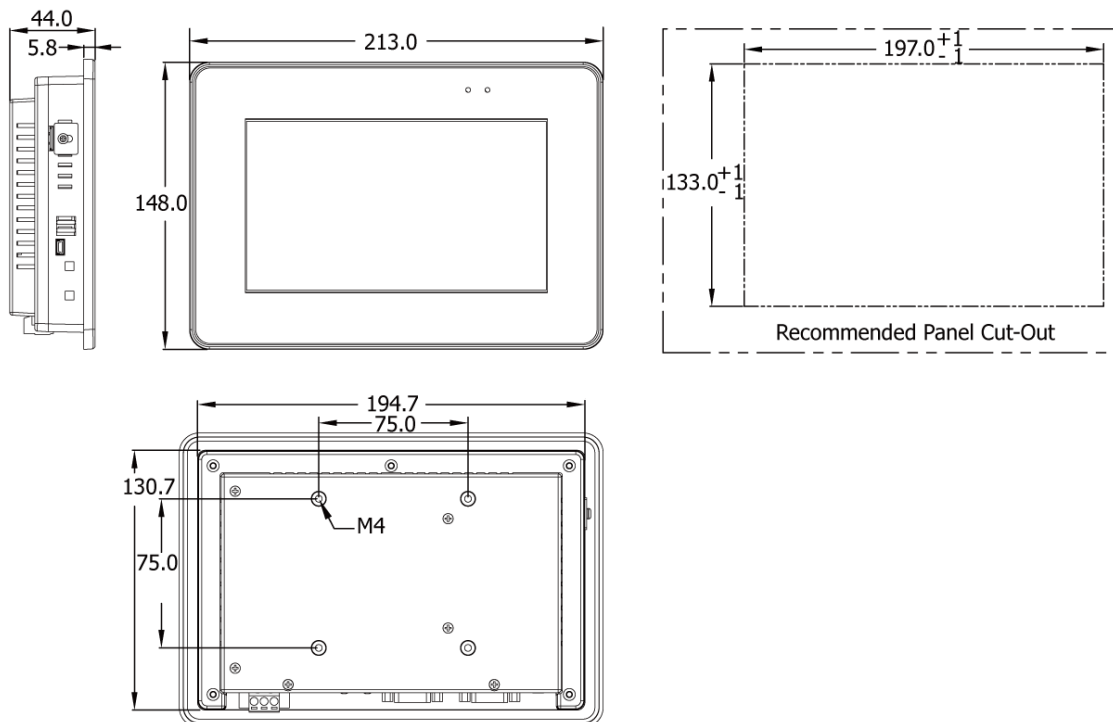

VP-3201-CE7

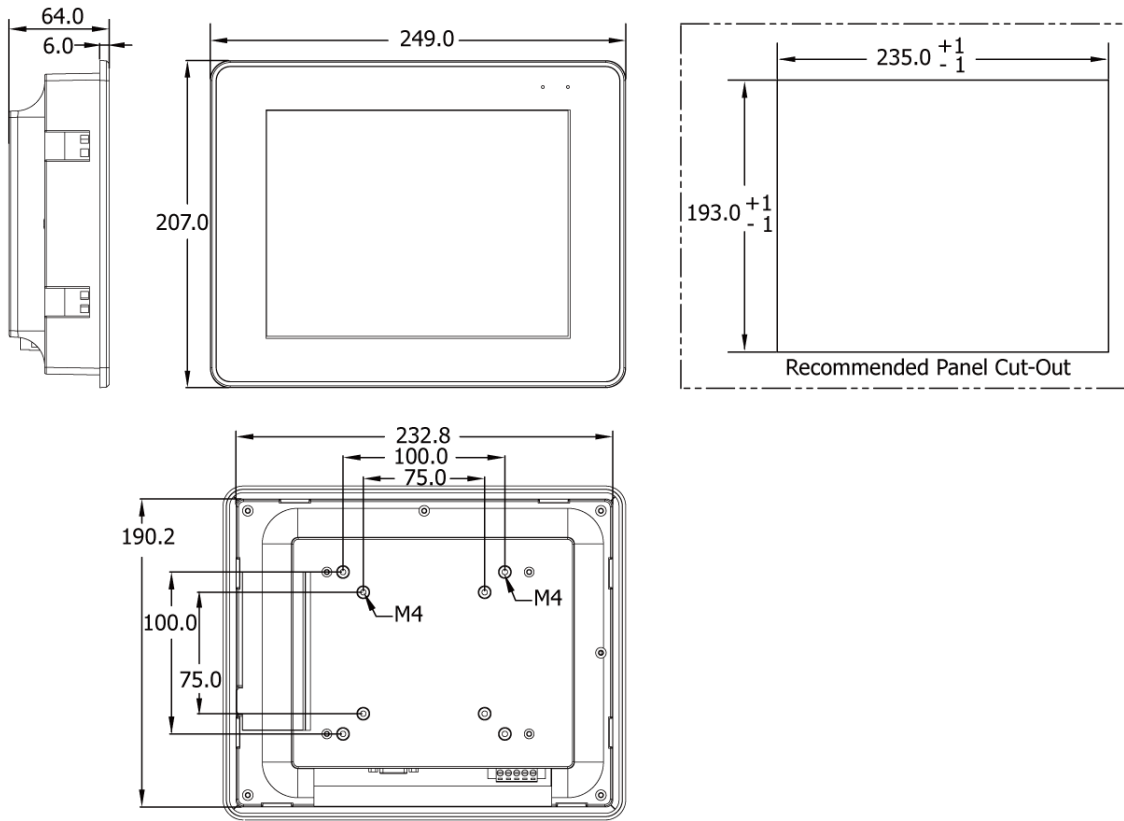

VP-4201-CE7

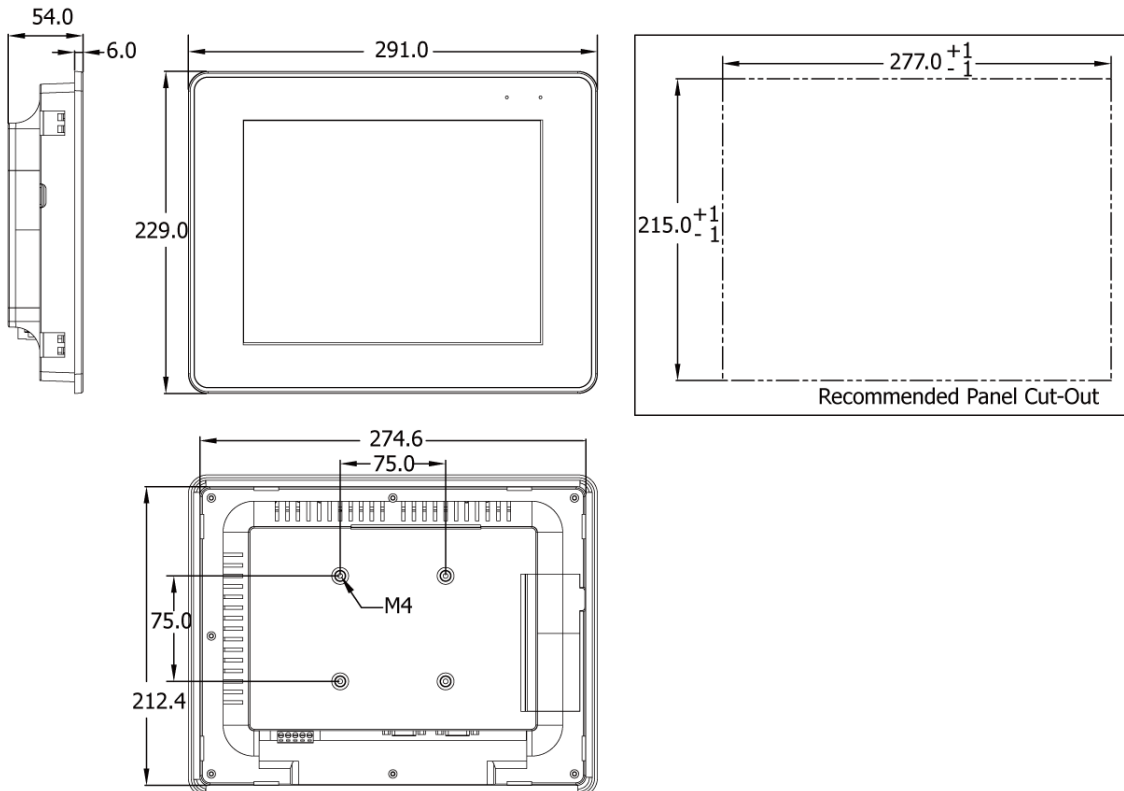

VP-5201-CE7

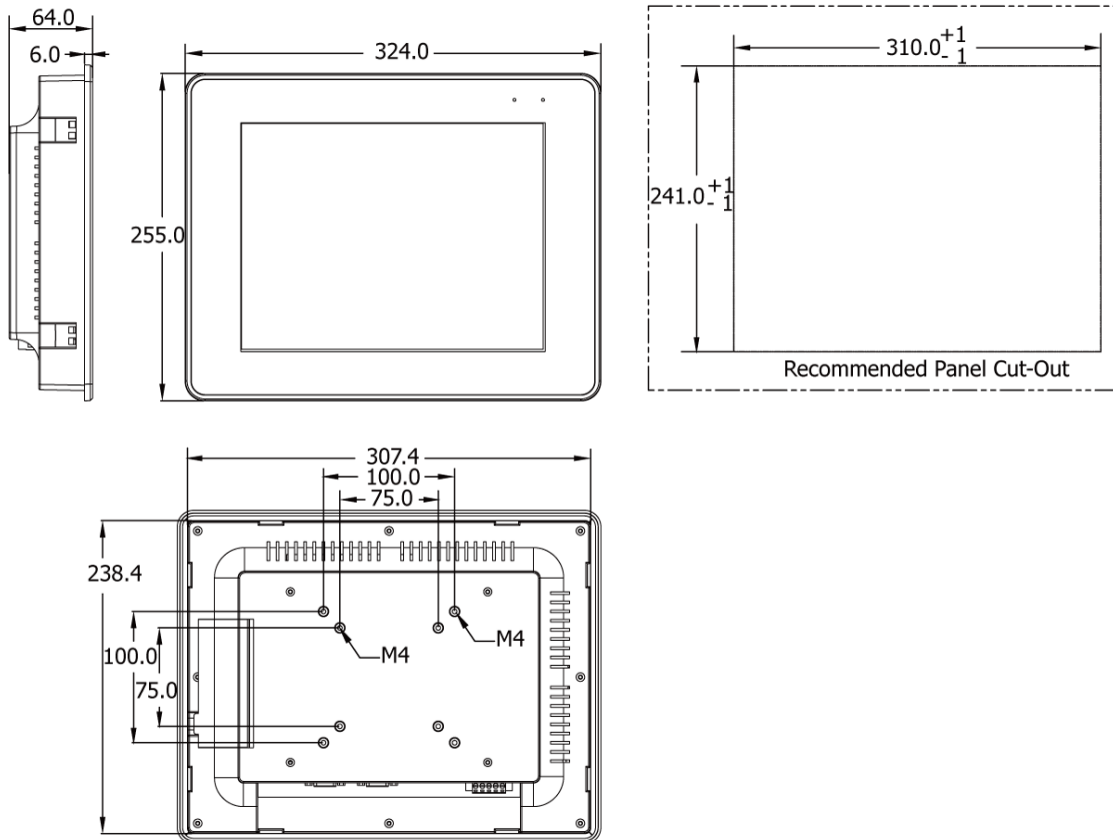

VP-6201-CE7

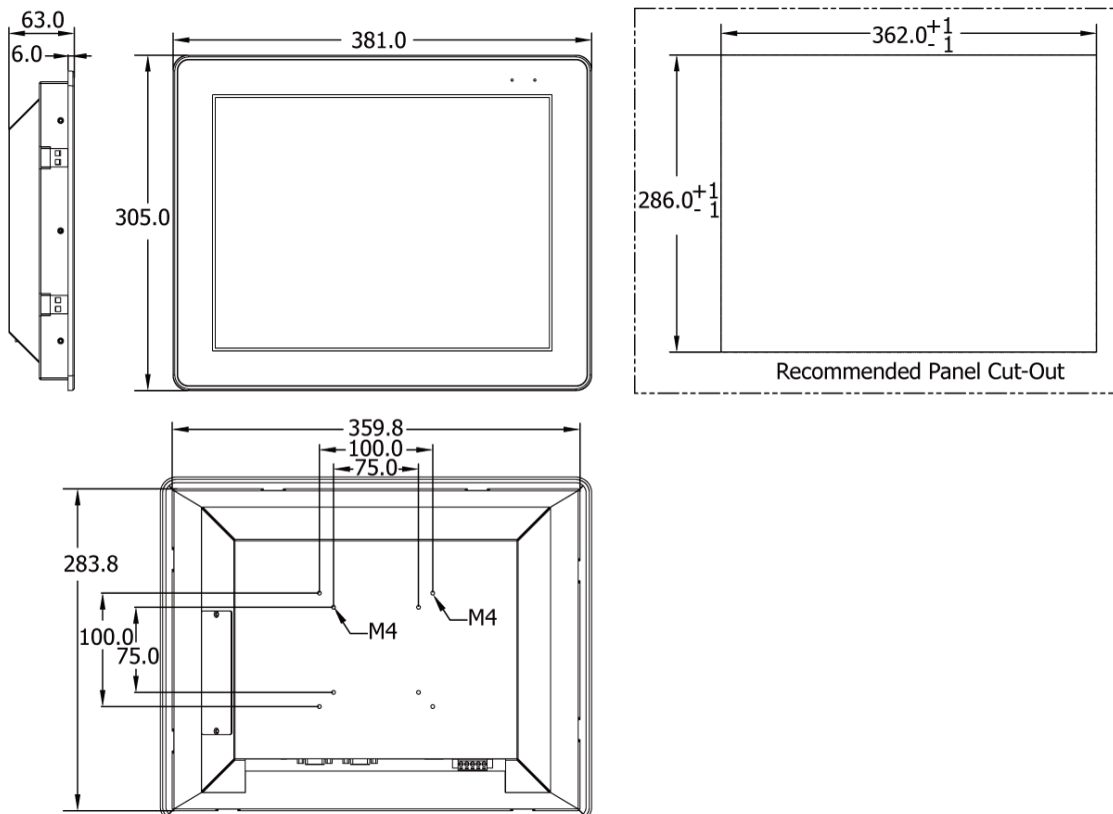

1.5. Companion CD

This package comes with a CD that provides a collection of the software utility, documentation, drivers, demo program and application. The CD contains several subdirectories located in \VP-x231 directory. All of them are listed below.

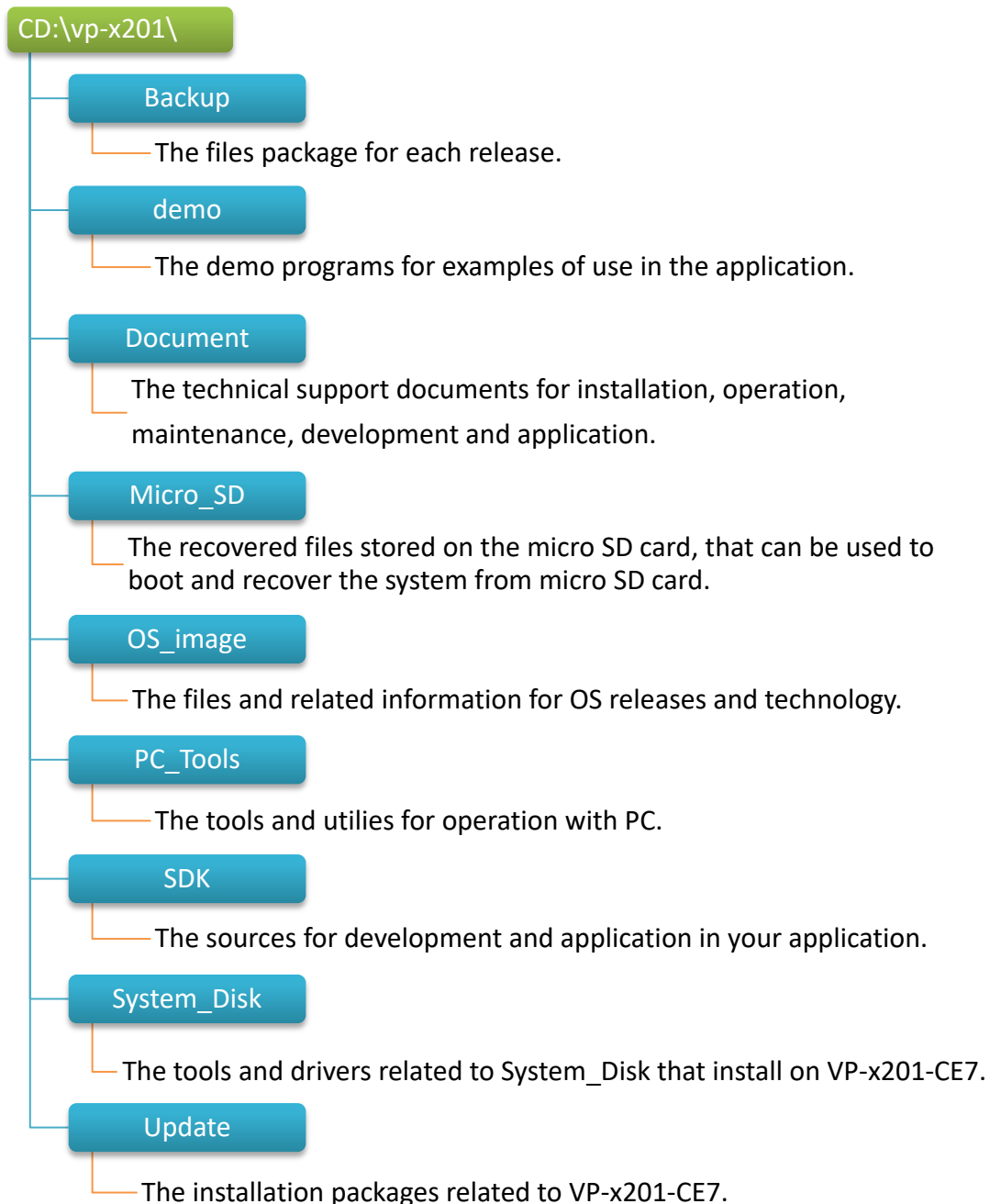

2. Getting Started

This chapter provides a guided tour of the VP-X201-CE7 installation and configuration that describes the steps needed to download, install, configure, and run the basic procedures for user working with the VP-X201-CE7 for the first time.

Before starting any task, please check the package contents. If any of the following package contents are missing or damaged, contact your dealer, distributor.



VP-X201-CE7



A microSD Card and A microSD to SD Adapter

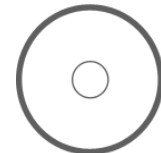

Software Utility CD



Touch Pen



Screw Driver



Panel clip x 4



M4 x 30L, Screw x 4

2.1. Mounting the VP-X201-CE7

The VP-X201-CE7 can be mounted on a panel of maximum thickness 12 mm. Adequate access space can be available at the rear of the instrument panel for wiring and servicing purposes.

Tips & Warnings



To ensure proper ventilation for the VP-X201-CE7, leave a minimum of 50 mm space between the top and bottom edges of the VP-X201-CE7 and the enclosure panels.

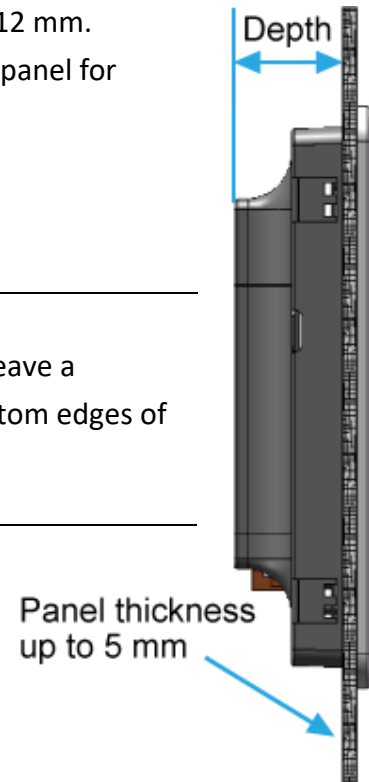

Models	Depth
VP-2201-CE7	32.0 mm
VP-3201-CE7	51.1 mm
VP-4201-CE7	41.1 mm
VP-5201-CE7	51.0 mm
VP-6201-CE7	51.3 mm

Step 1: Prepare the panel and cut the hole to the specified size

Models	Panel Cut-Out (Width x Height)
VP-2201-CE7	200 mm x 133 mm, ± 1 mm
VP-3201-CE7	234 mm x 192 mm, ± 1 mm
VP-4201-CE7	276 mm x 214 mm, ± 1 mm
VP-5201-CE7	309 mm x 240 mm, ± 1 mm
VP-6201-CE7	362 mm x 287 mm, ± 1 mm

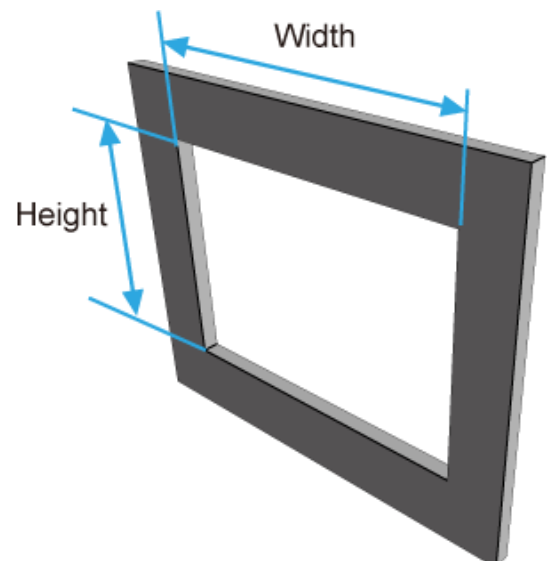

Step 2: Attach the VP-X201-CE7 to the cut-out hole



Step 3: Insert the panel mounting clips into the upper and lower ventilation holes

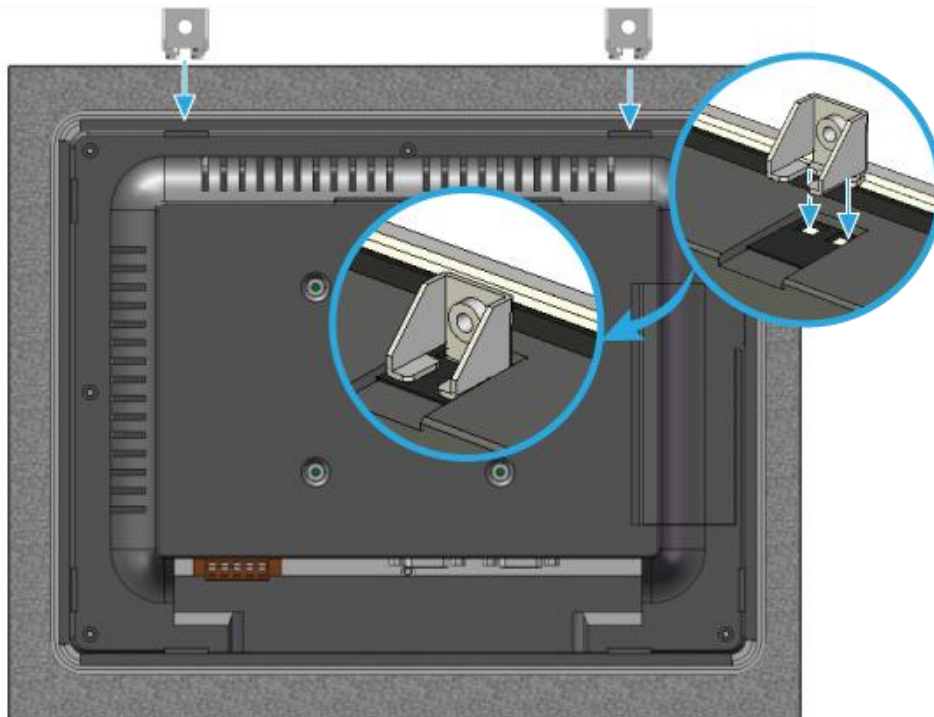

Step 4: Screw the panel mounting clips to the panel.

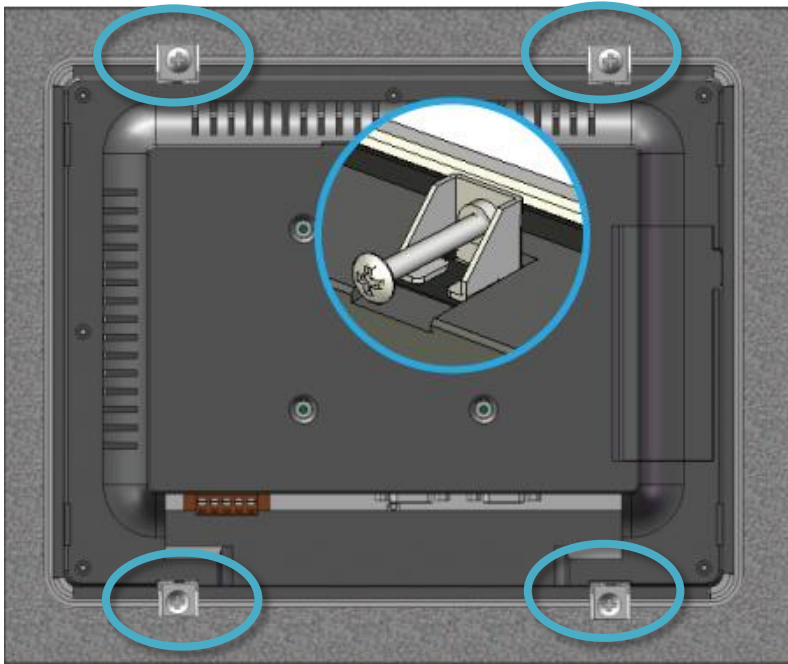

Tips & Warnings



Recommended Screw Torque: 3.4 ~ 4.5 kgf-cm.

2.2. Deploying a Basic VP-X201-CE7 System

The VP-X201-CE7 provides a variety of communication interface to suit a range of application. Here is a simple application for using the VP-X201-CE7.

Step 1: Make sure that the rotary switch is in the 0 position

Step 2: Connect the positive terminal (+) of the power supply to the terminal PWR1/2 and the negative terminal (-) of the power supply to the P.GND

Step 3: Connect the USB mouse or the USB keyboard to the USB port

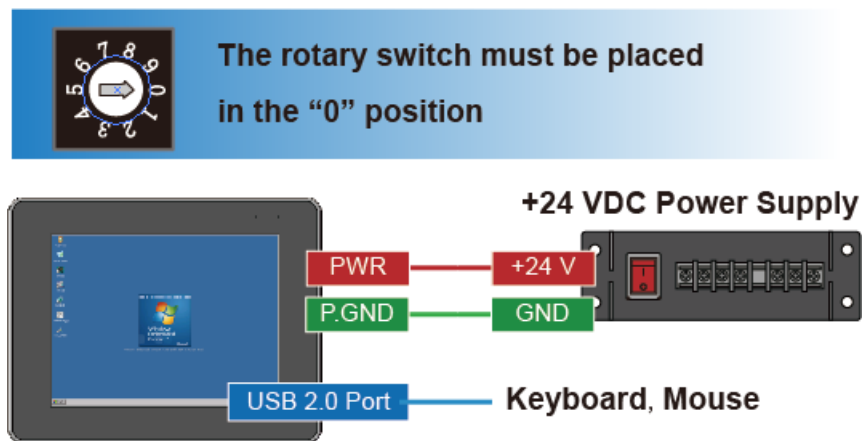

2.3. Configuring the Boot Mode

The VP-X201-CE7 has several operating modes, which can be selected by a rotary switch.



The table below lists the operation modes available with the VP-X201-CE7.

Position	Operating Mode
0	Normal mode (Default)
1	Safe mode
2	Debug mode
3	OS update mode by Ethernet
4	Reserve
5	OS update mode by Micro_SD
6	Reserve (OS Development Mode)
7 ~ 9	User Mode

The following is a brief introduction of these modes.

Normal Mode (Default mode)

Normal mode is the default mode of operation and the one you will use most of the time. Use this mode for more tasks and configurations. Programs also are executed in this mode.

Safe Mode

Safe mode is a trouble shooting. The mode loads the minimum required device drivers and system services to boot the VP-X201-CE7.

If you have malicious software or a program caused the VP-X201-CE7 cannot be boot or run the normal mode, you can boot in safe mode to solve the problem.

Debug Mode

Debug mode is a special environment in which program debug functions can be used in addition to normal system functions.

Debug mode is unsupported.

OS Update Mode

OS update mode is a way used to update OS. For more information on updating the VP-X201-CE7 OS image, please refer to section 6.1. OS updates

Reserve → OS Development Mode

The positions 4, 6, of rotary switch are reserved for OS development.

User Mode

The positions 7, 8, 9 of rotary switch are reserved for user's applications.

When VP-X201-CE7 is boot with one of these positions, it is boot at normal mode.

User's application can check the position of the rotary switch position to run at different mode.

2.4. Changing the User Interface Language

The **Regional and Language Settings** is a Windows CE functionality that allows users to change the VP-X201-CE7 user interface with your native language.

Step 1: Click Start menu, point to Settings, click Control Panel, and then click Regional Settings

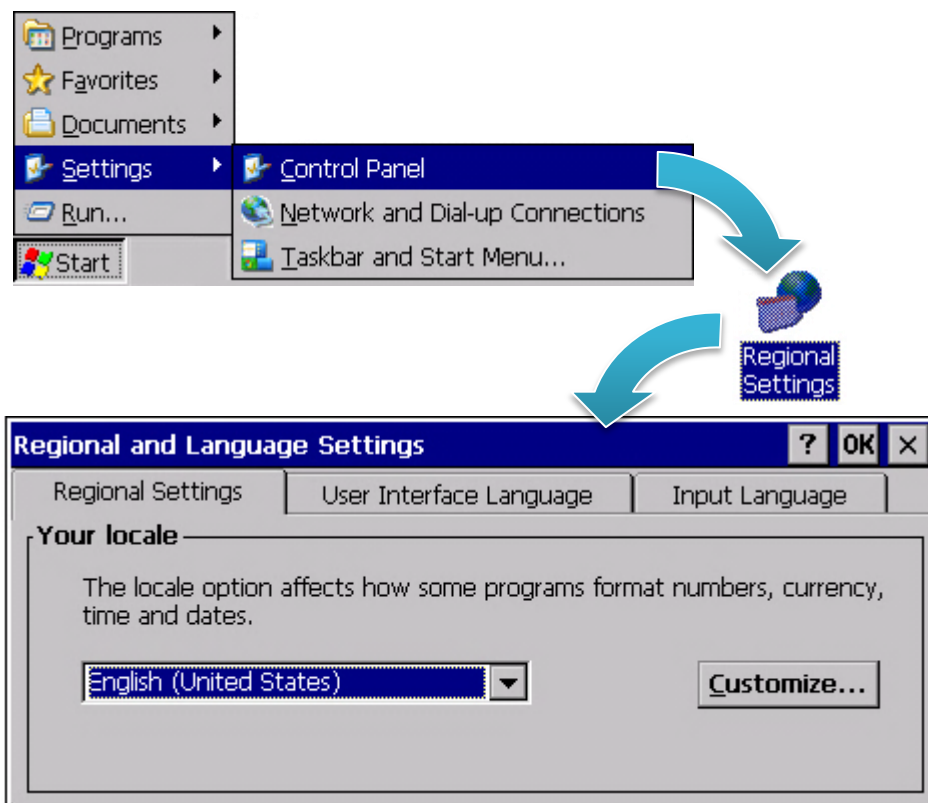

Step 2: Click User Interface Language tab, choose to your local language, and then click OK button



Step 3: Double-click the PAC Utility on the desktop, and then reboot the VP-X201-CE7 for changes to take effect

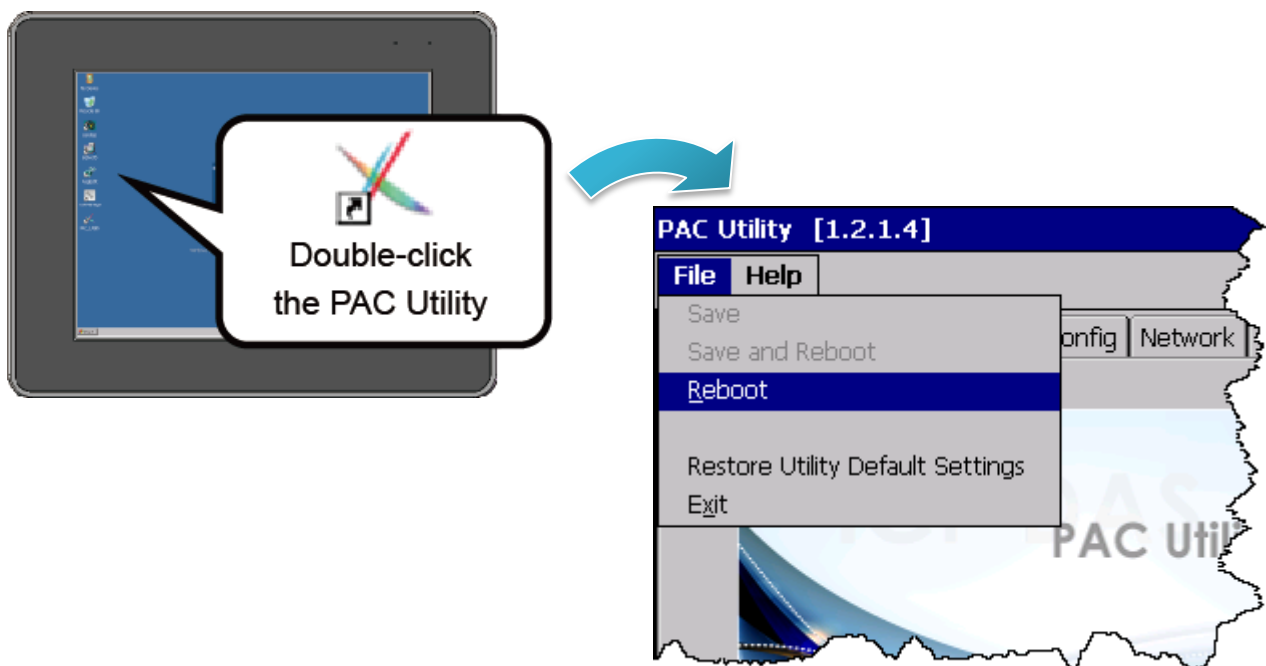

2.5. Using PAC Utility to Manage the VP-X201-CE7

The PAC Utility is a collection of the VP-X201-CE7 system tool that allows users to manage and configure the VP-X201-CE7 quickly and easily.

For more detailed information on PAC Utility applications, please refer to “3.1. PAC Utility”

Step 1: Double-click the PAC Utility on the desktop

Step 2: Configure IP address (DHCP), FTP Server, Auto Execution files..., etc

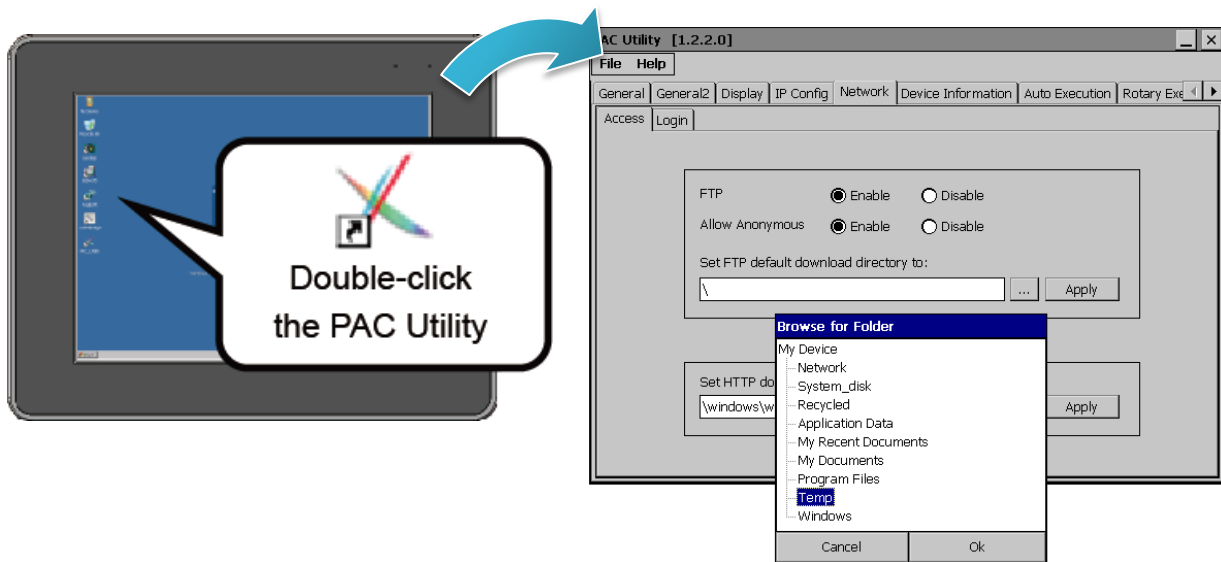

Step 3: Reboot the VP-X201-CE7

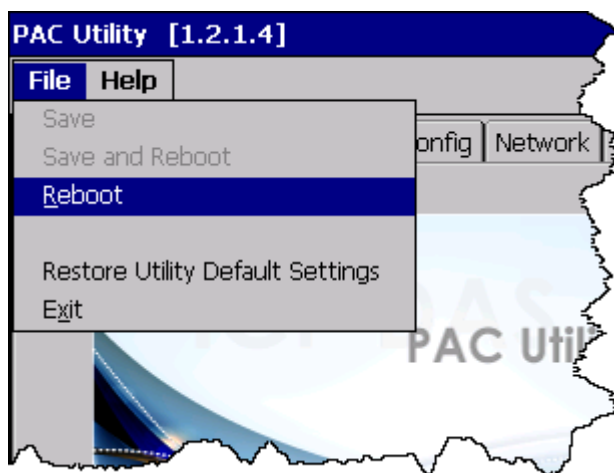

3. Tools and Tasks

This chapter provides a brief introduction of the VP-X201-CE7 service tools and its benefits.

There are several tools and utilities built-in and designed for use with VP-X201-CE7. Some of these are pre-installed on VP-X201-CE7 and can work directly on VP-X201-CE7, and some of these are supporting tools and can help you to manage the VP-X201-CE7 remotely on a PC.

The following tools are pre-installed on VP-X201-CE7 and can work directly on VP-X201-CE7 that can be found on the CD that was provided with the package or by downloading the latest version from ICP DAS web site.

CD:\vp-x201\System_Disk\Tools\

http://ftp.icpdas.com/pub/cd/winpac_am335x/vp-x201/system_disk/tools/

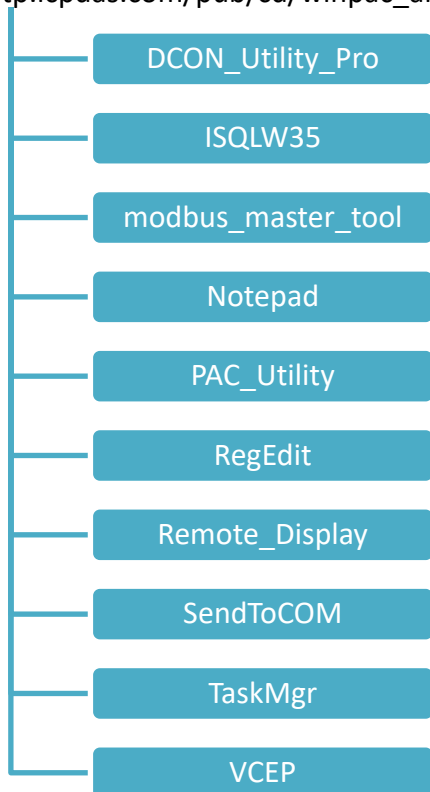

3.1. PAC Utility

PAC Utility is a collection of software applications that enable management and configuration of VP-X201-CE7 system and features.

PAC Utility is subject to change

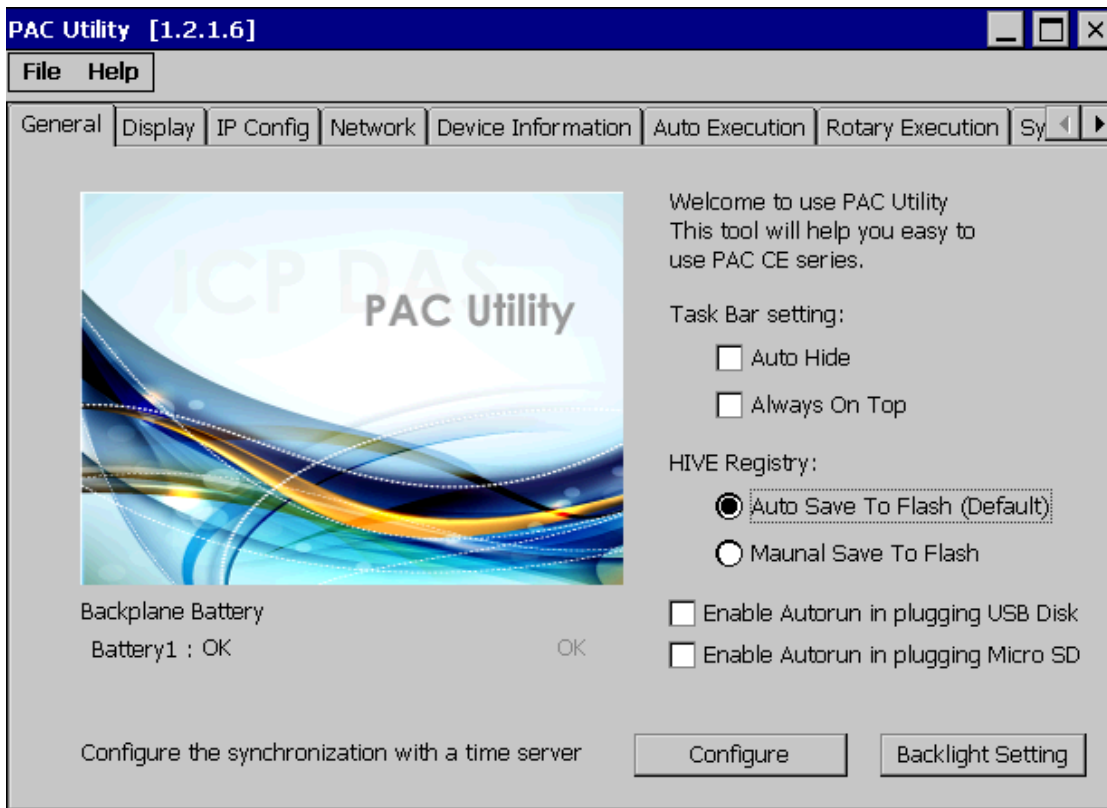

The PAC Utility includes the following menu bars and property tabs.

All of these functions will be explained later.

Menu bar	Property Tab
File	General
Help	Display
	IP Config
	Network
	Device Information
	Auto Execution
	Rotary Execution

3.1.1. Menu Bar – File

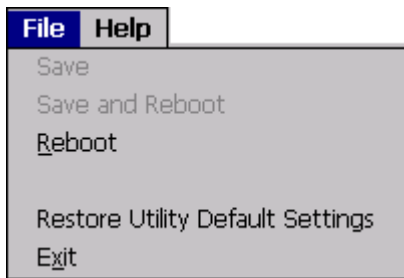

The menus use to	How to use
Reboot	Restarts the VP-X201-CE7
Restore Default Settings	Restore the VP-X201-CE7 settings to its default.
Exit	Exits the PAC Utility.

3.1.2. Menu Bar – Help

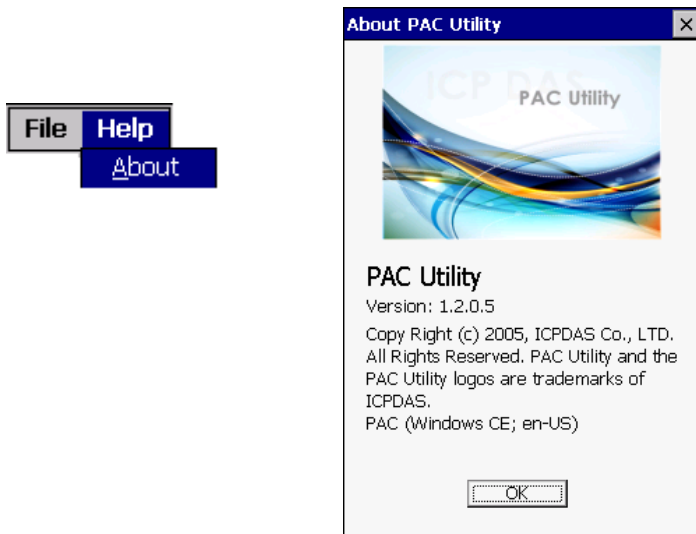

The menus use to	How to use
About	Displays a dialog box with information about PAC Utility, including the current version and copyright information.

3.1.3. Property Tab - General

The **General** tab provides functions to configure the task bar, check the status of the battery..., etc.

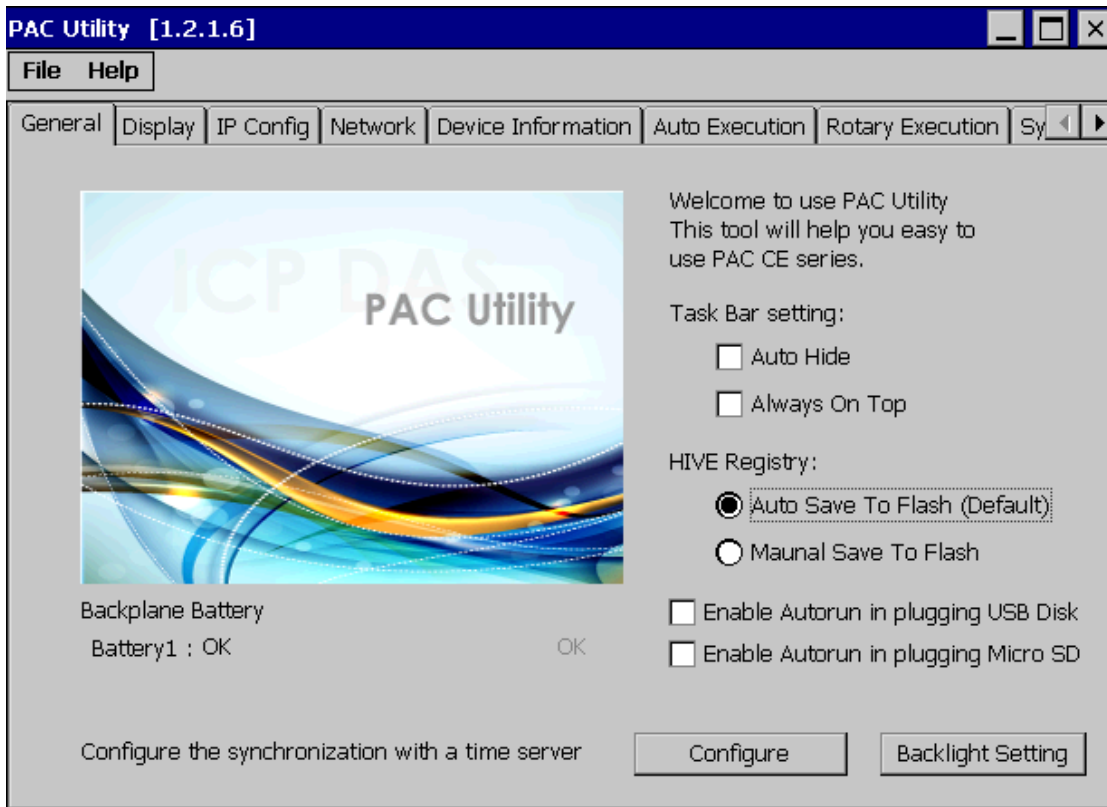

The tab use to	How to use
Lock or Auto-Hide the taskbar	<p>Auto-Hide the taskbar: Select the Auto Hide check box.</p> <p>Lock the taskbar: Select the Always On Top check box.</p>
Auto save or manual save to flash	<p>Auto save to flash: Select the Auto Save To Flash (Default) check box. Any changes made to the VP-X201-CE7 will be saved and only take effect after the VP-X201-CE7 reboots.</p> <p>Manual save to flash: Select the Manual Save to Flash check box. Any changes made to the VP-X201-CE7 will be saved by clicking the Save and Reboot from File menu.</p>

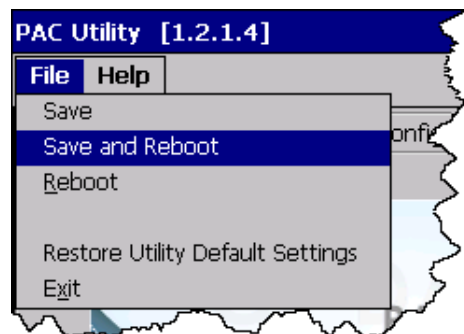

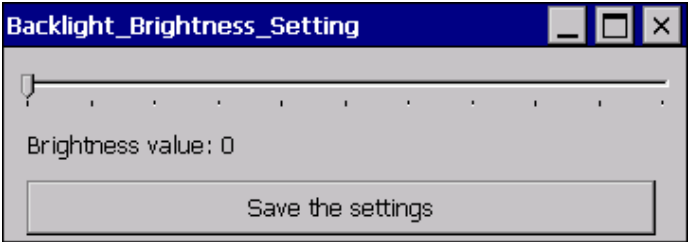
The tab use to	How to use
Enable USB autorun	Select the Enable Autorun in plugging USB Disk check box.
Enable microSD auotrun	This item is temporarily unavailable.
Automatic synchronization of system time	Refer to the Appendix A.2. How to configure the service for automatically synchronizing with the internet time server.
Adjust the backlight	<p>Move the slider to the left to decrease the brightness or move the slider to the right to increase the brightness, and then click the Save the settings button.</p> 

3.1.4. Property Tab – Display

The **Display** tab provides functions to configure the monitor settings.

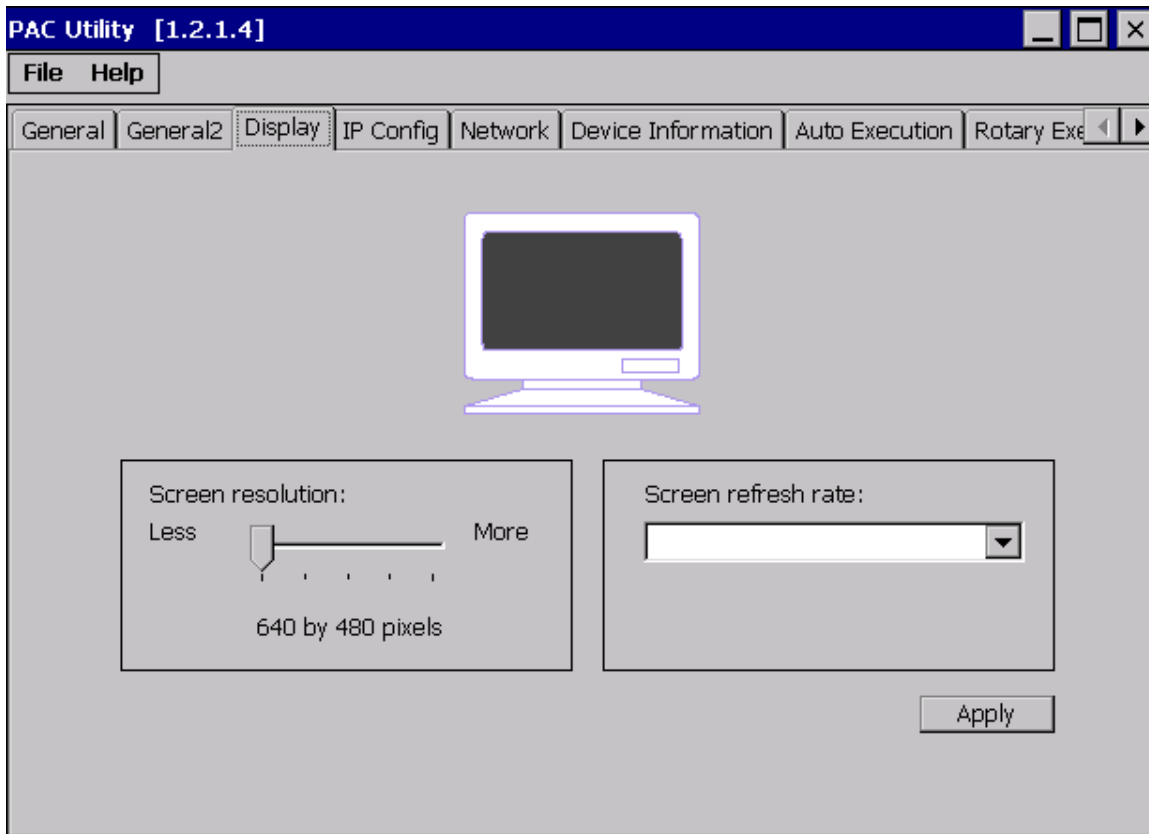

The tab use to	How to use
Adjust the screen resolution	Move the slider to the left to decrease the resolution or move the slider to the right to increase the resolution, and then click the Apply button.
Change the screen refresh rate	Select the desired refresh rate from the Screen refresh rate drop-down list, and then click the Apply button.

3.1.5. Property Tab – IP Config

The **IP Config** tab provides functions to configure either DHCP (Roaming) or manually configured (Static) network settings and to monitor the MAC address. Generally, DHCP is the default settings, but if you don't have a DHCP server, you must configure the network settings by using manual configuration.

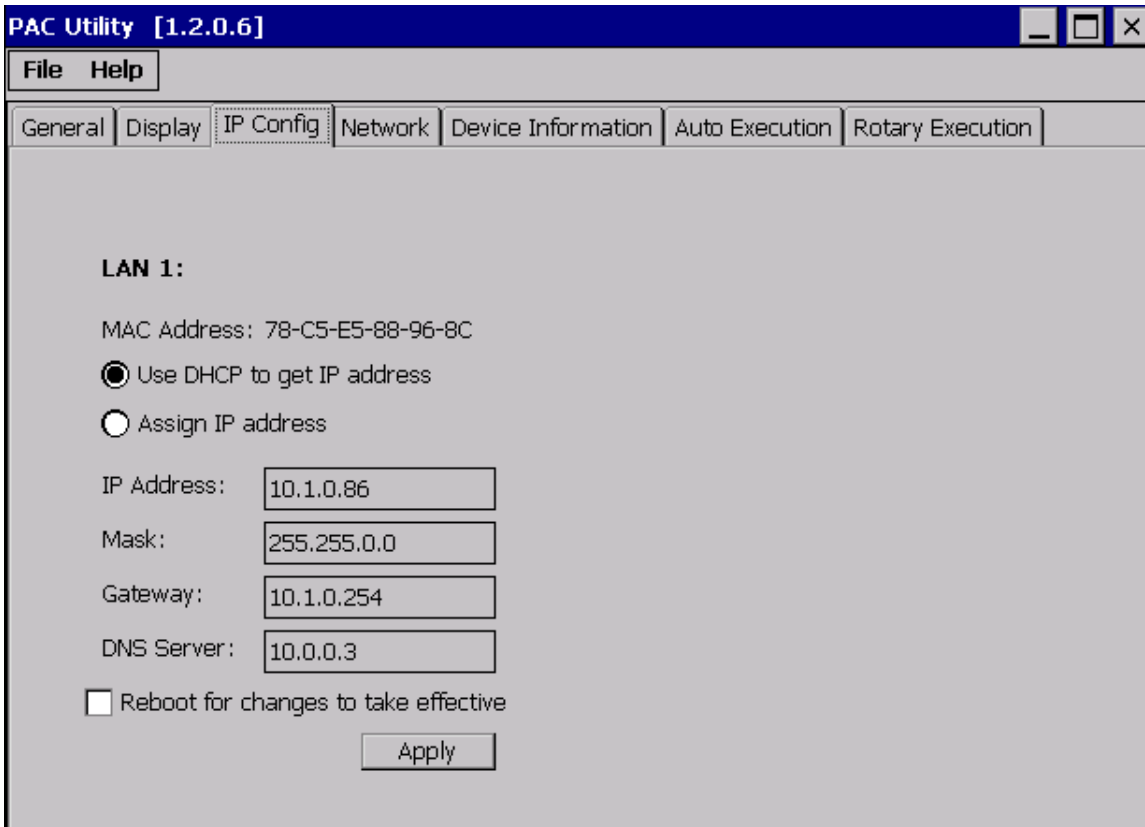

The tab use to	How to use
Set the network settings	<p>Use DHCP to get IP address: Select the Use DHCP to get IP address option, and then click the Apply button.</p> <p>Assign an IP address: Select the Assign IP address option, and then click the Apply button.</p>

3.1.6. Property Tab – Network

The **Network** tab comprises three tabs – Access, Login and File Server Settings.

Access

The **Access** tab provides functions to enable/disable the FTP access, enable/disable anonymous FTP access, and configure the FTP and HTTP directory path.

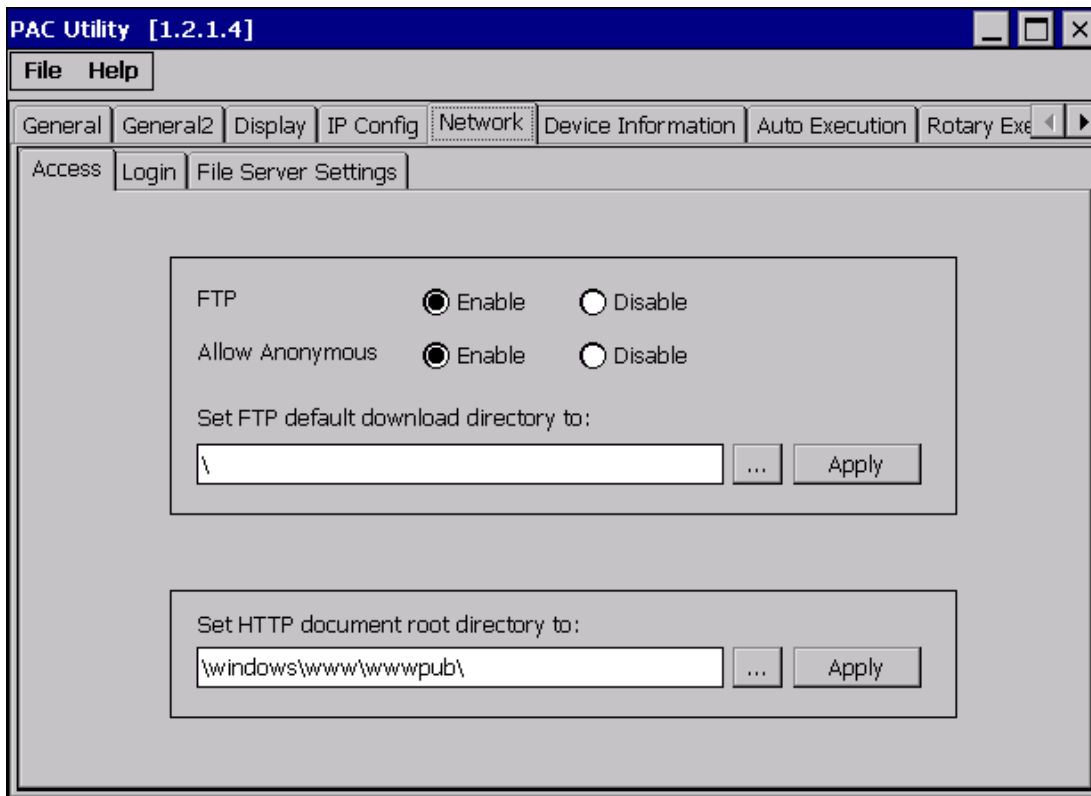

The tab use to	How to use
Enable or disable the FTP access	<p>Enable the FTP access: Select the Enable check box in the FTP field, and then click the Apply button.</p> <p>Disable the FTP access: Select the Disable check box in the FTP field, and then click the Apply button.</p>

The tab use to	How to use
Enable or disable anonymous FTP access	<p>Enable anonymous FTP access: Select the Enable check box in the Allow Anonymous field, and then click the Apply button.</p> <p>Disable anonymous FTP access: Select the Disable check box in the Allow Anonymous field, and then click the Apply button.</p>
Set the FTP directory path	Enter a new path in the Set FTP default download directory to: field, and then click the Apply button.
Set the HTTP directory path	Enter a new path in the Set HTTP document root directory to: field, and then click the Apply button.

Login

The **Login** tab provides functions to maintain the FTP accounts.

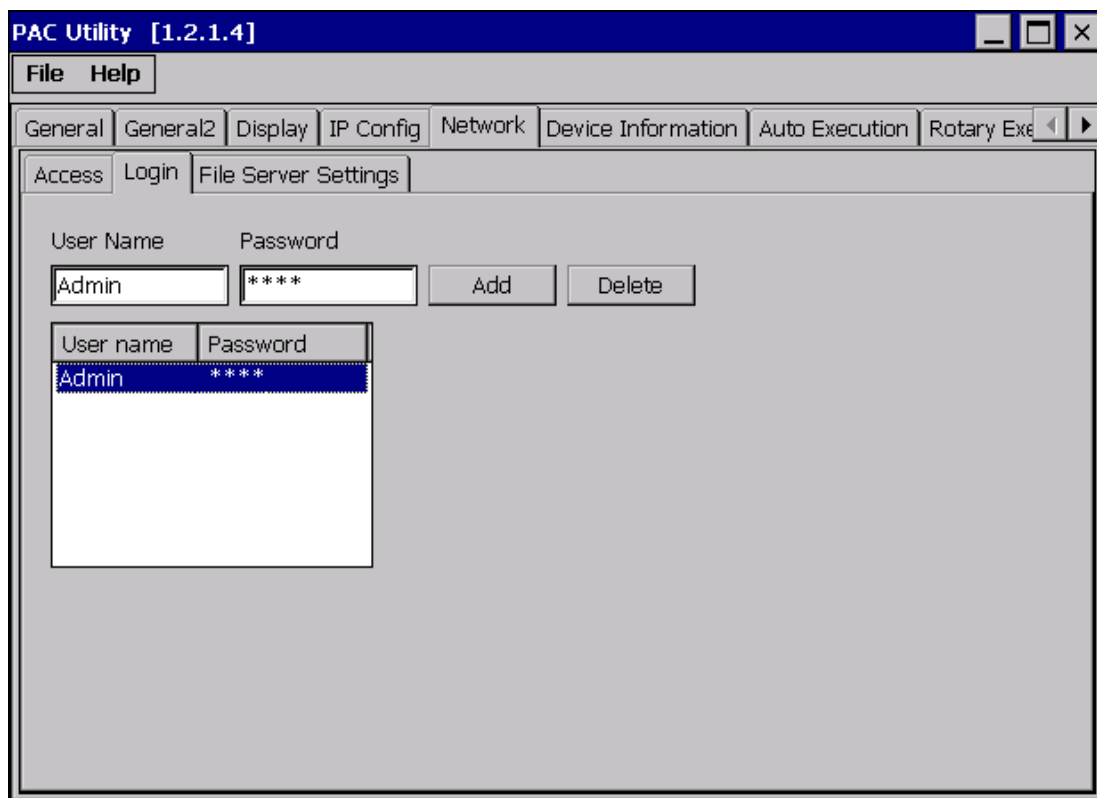

The tab use to	How to use
Maintain the FTP accounts	Refer to the Appendix C.1 How to add a user account to remote login the VP-X201-CE7 from PC.

File Server Settings

The **File Server Settings** tab provides functions to set the SMB server.

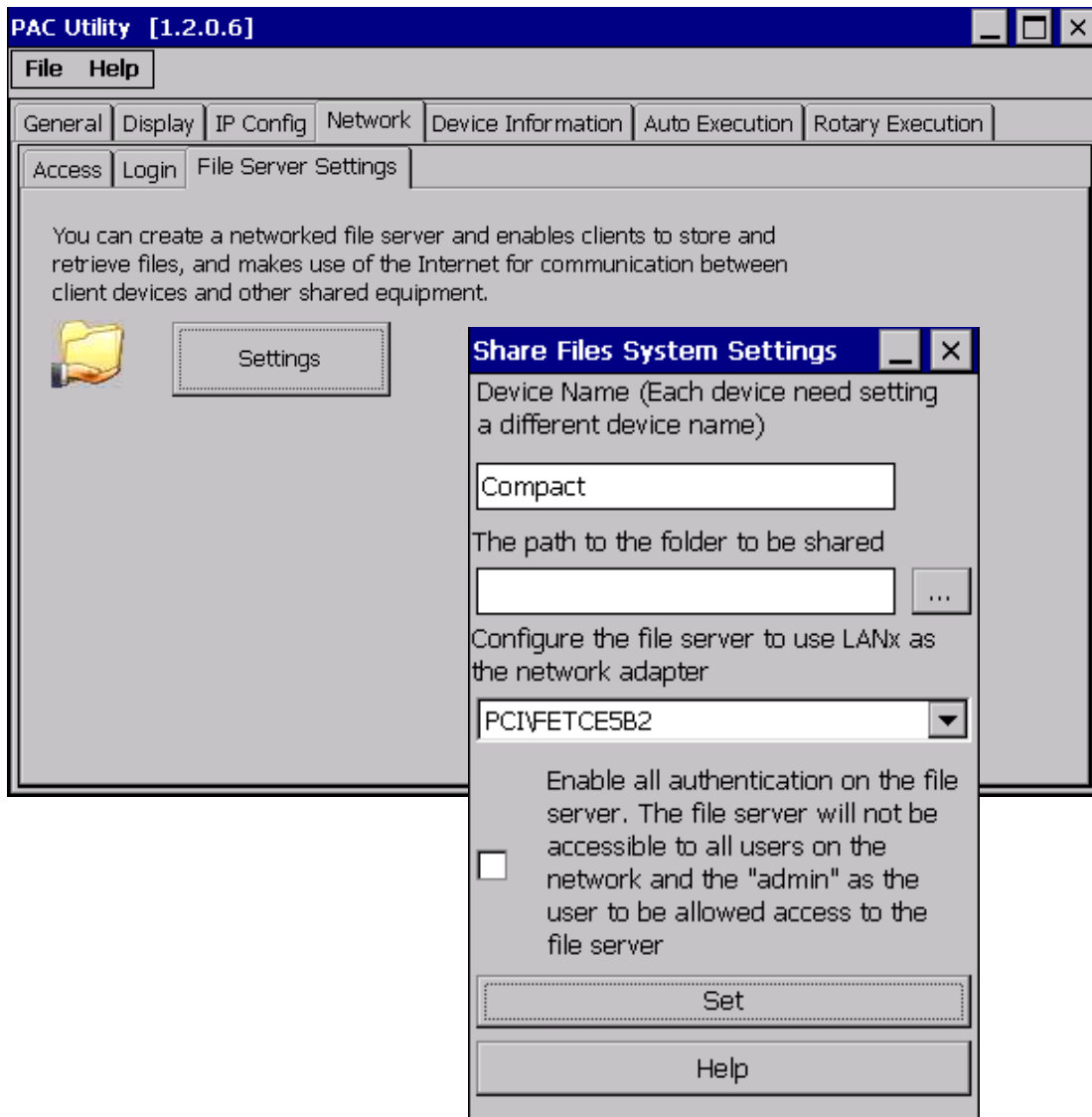

The tab use to	How to use
Set the SMB server	Click the Settings button to set the SMB server path.

3.1.7. Property Tab – Device Information

The **Device Information** tab provides functions to monitor necessary system information of the VP-X201-CE7. The information is the most important note of version control for upgrading system.

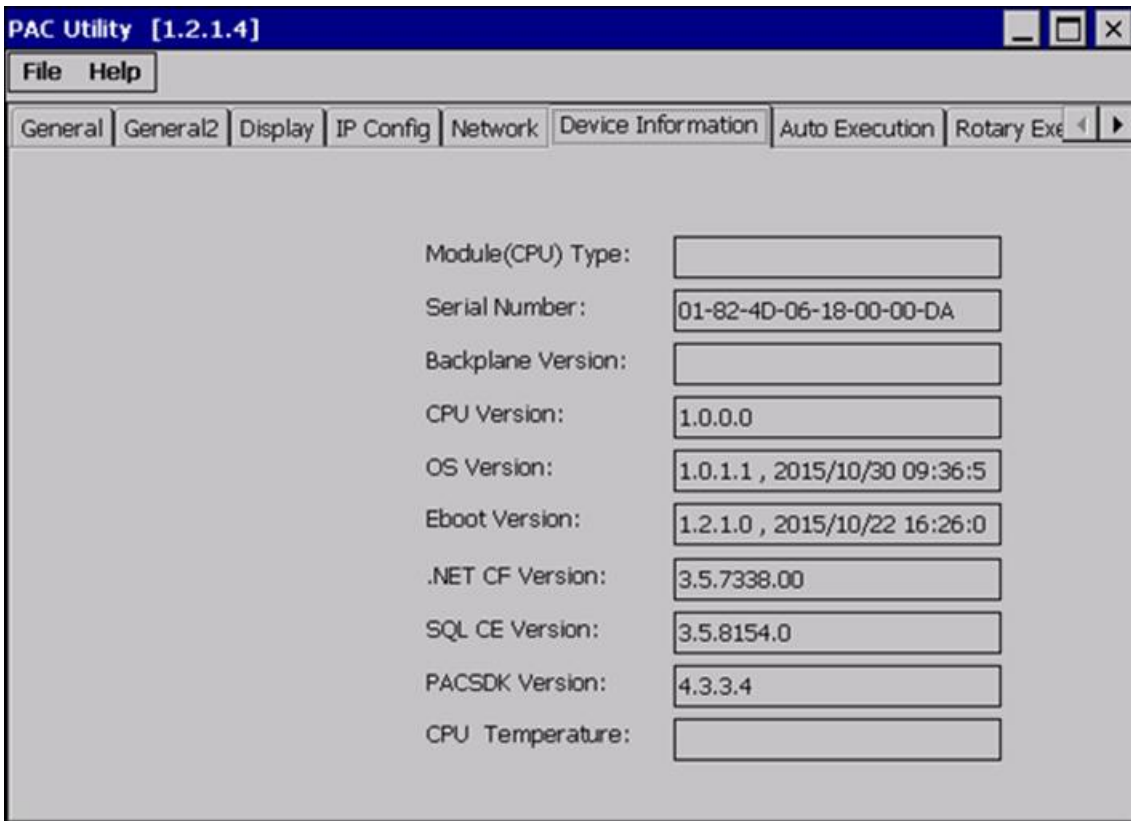

3.1.8. Property Tab – Auto Execution

The **Auto Execution** tab provides functions to configure programs running at VP-X201-CE7 startup, it allows users to configure ten execute files at most.

Tips & Warnings



The specific extensions are .exe and .bat, and they are executed in order of program 1, program 2, etc.

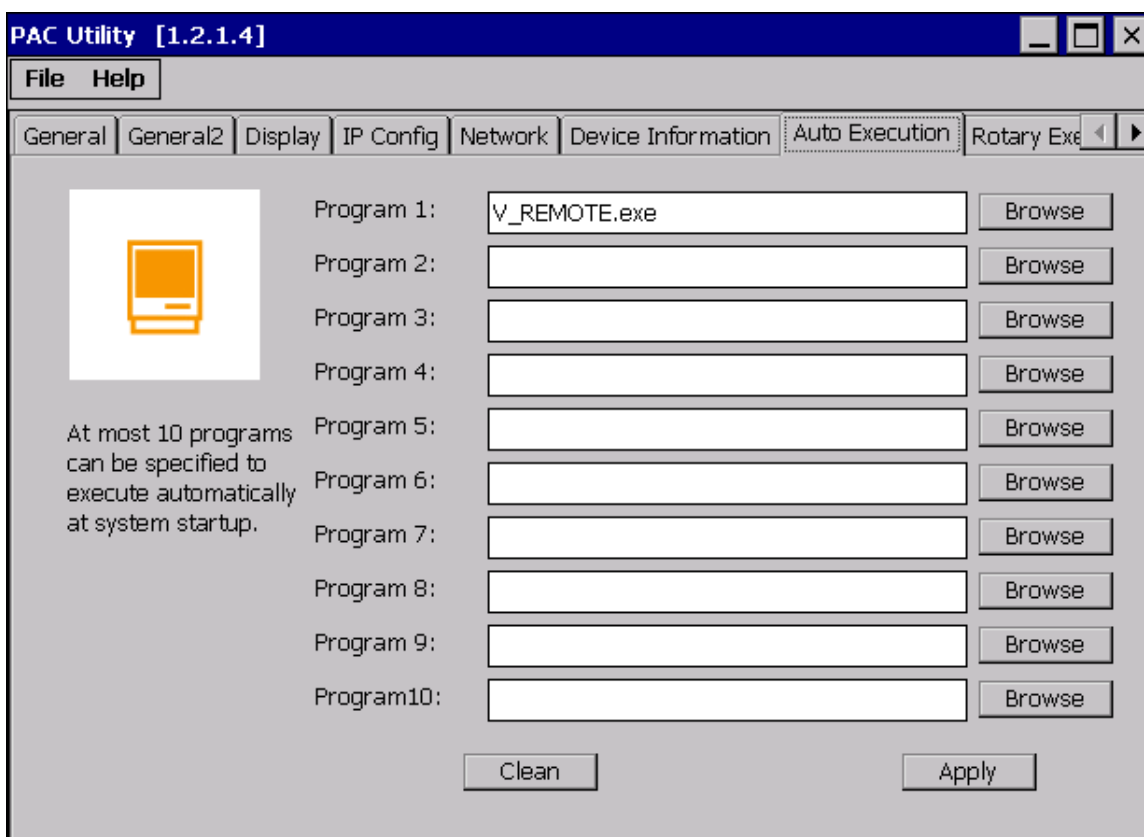

The tab use to	How to use
Configure programs running at startup	Click the Browse button to select the execute file which you want, and then click the Apply button.

3.1.9. Property Tab – Rotary Execution

The **Rotary Execution** tab provides functions to configure programs running at VP-X201-CE7 startup in one of the user defined mode, it allows users to configure ten execute files at most.

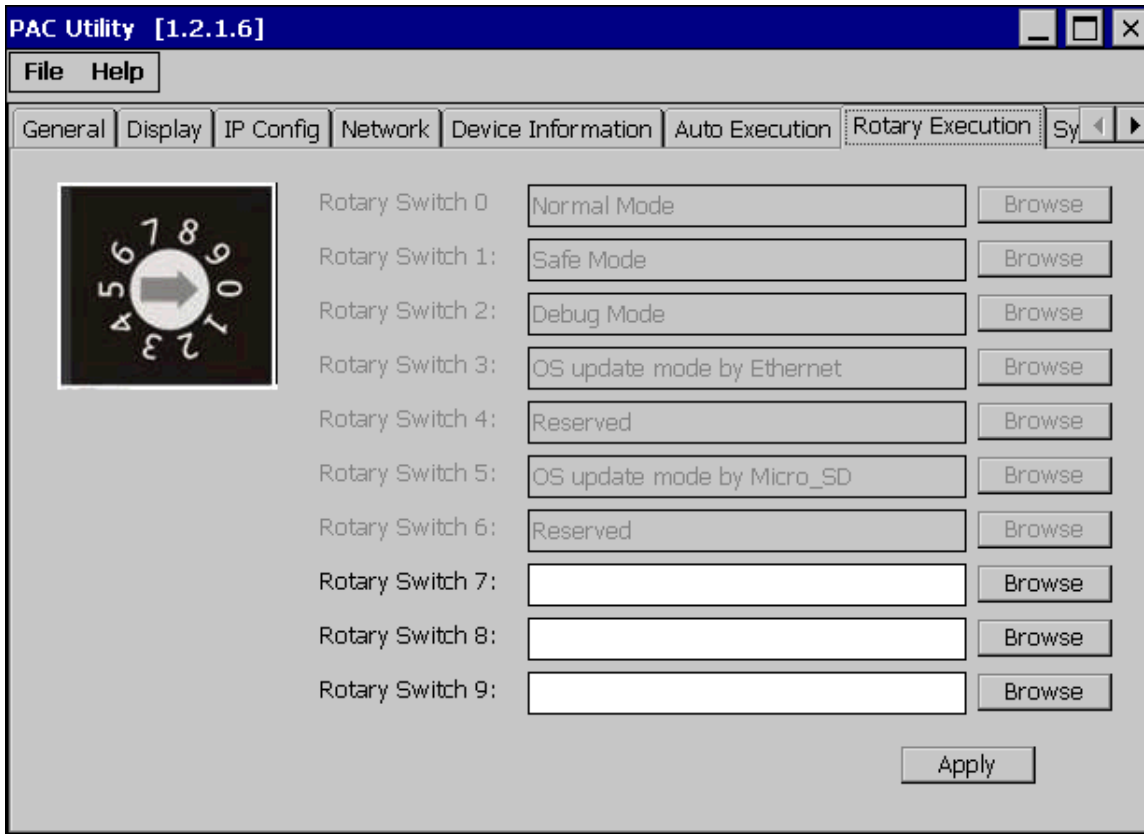

The tab use to	How to use
Configure programs running at startup in one of the user defined mode	Click the Browse button to select the execute file which you want, and then click the Apply button.

3.2. DCON Utility Pro

DCON Utility Pro enables users easily to configure and manage the I/O modules via Ethernet or serial ports (RS-232/RS-485).

For more information on how to use DCON Utility Pro to configure I/O modules, please refer to 2.5. Using DCON Utility Pro to Configure I/O Modules

For more detailed information on DCON Utility application, please refer to:

http://www.icpdas.com/root/product/solutions/software/utilities/dcon_utility_pro.html

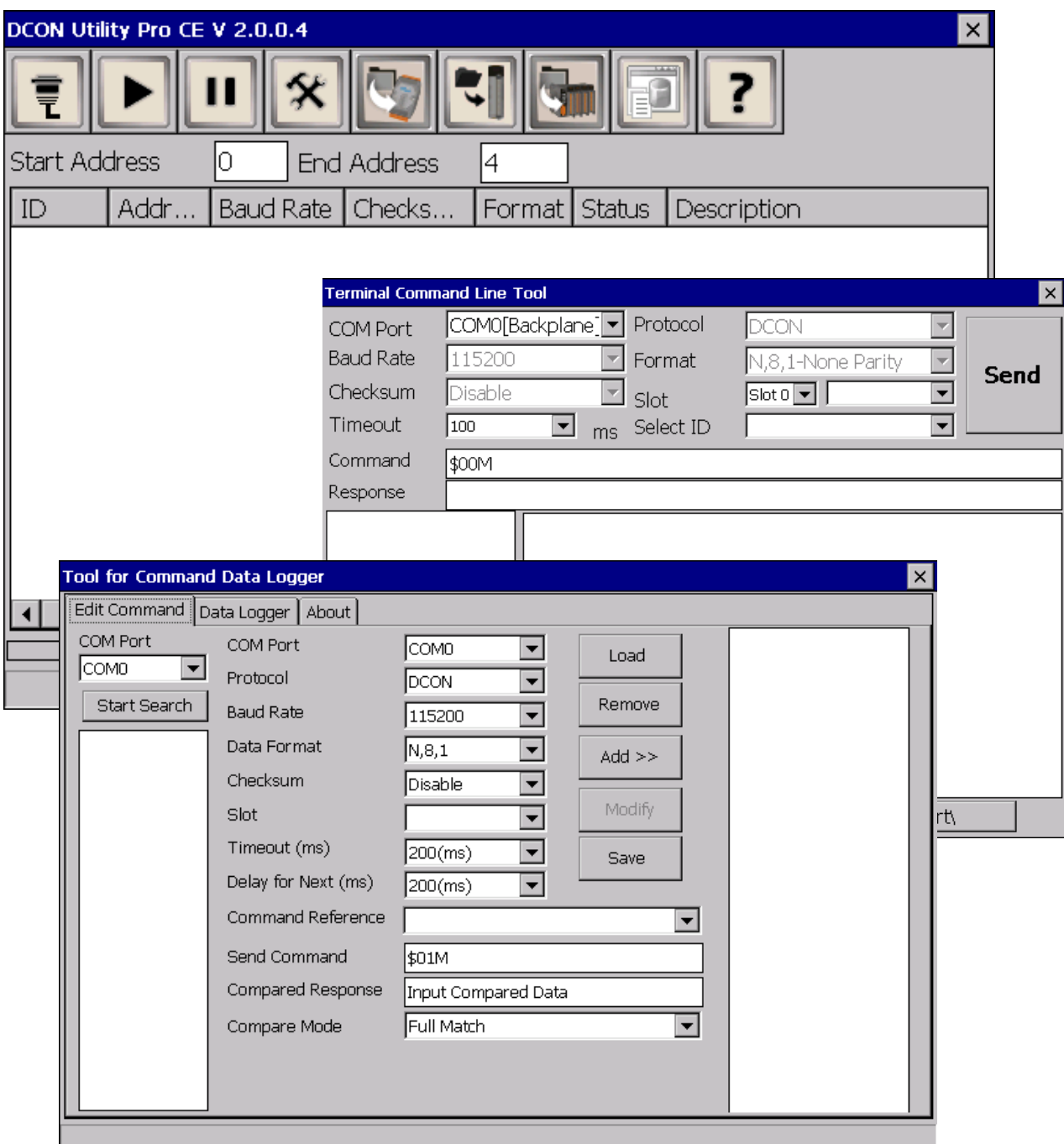

3.3. TaskMgr

The TaskMgr is a Windows CE application, which provides real time info on all processes and threads including System threads, similar in appearance to the Windows Task Manager.

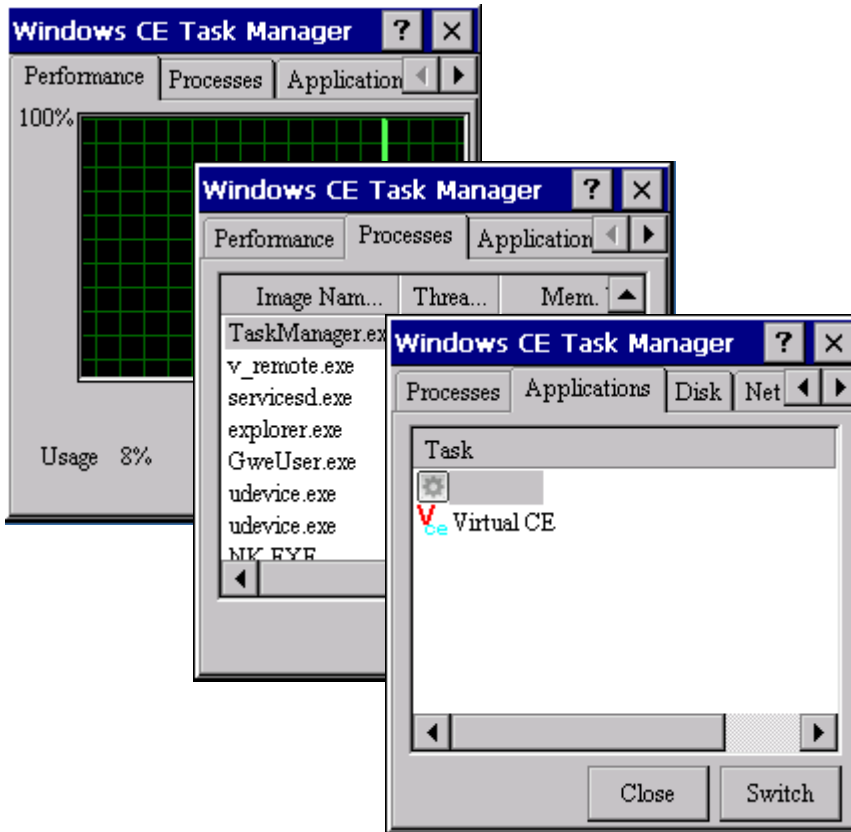

3.4. VCEP

ICP DAS VCEP is designed for managing your VP-X201-CE7 anywhere. No matter where you are, ICP DAS VCEP provides a convenient environment on the Desktop PC and lets you control your VP-X201-CE7 remotely.

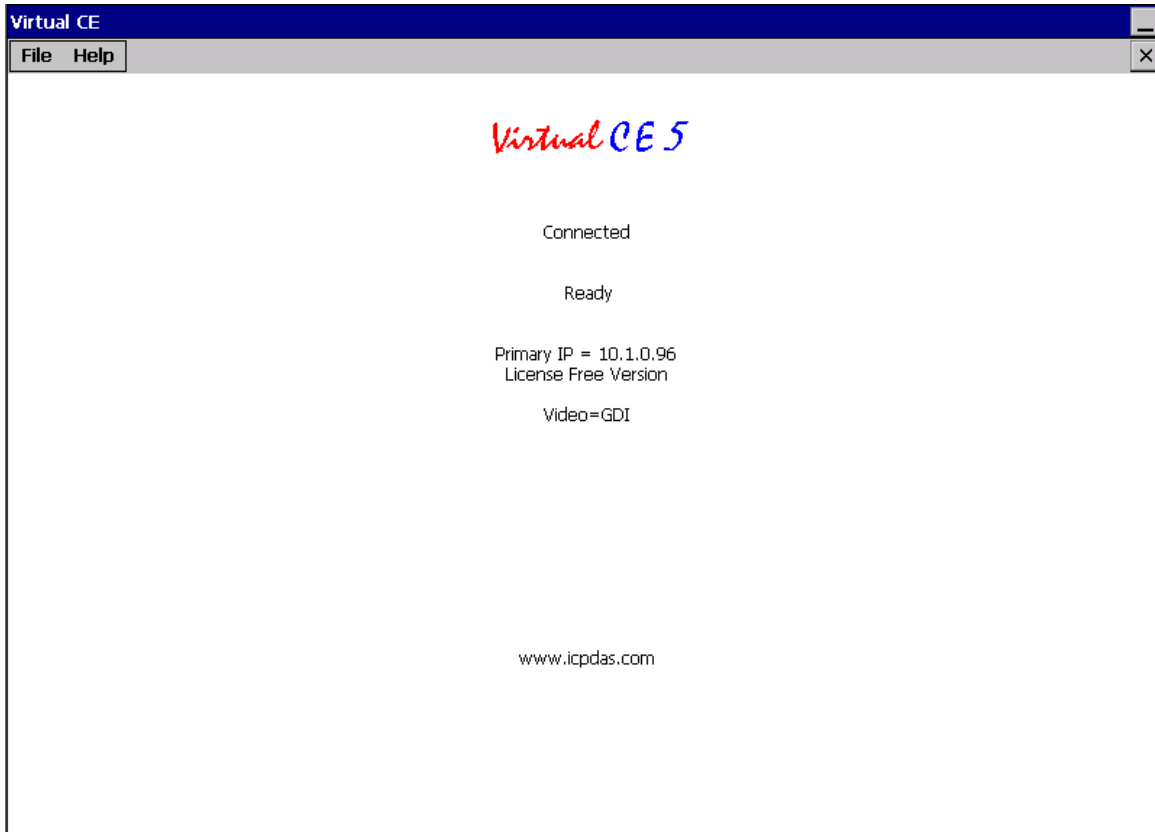

ICP DAS VCEP is composed of two main components: The **Server** which runs on VP-X201-CE7 and the **Client** which runs on a Desktop PC.

Once a connection is established between the client and server (initiated by the client), the client will periodically send requests for screen updates and send mouse/key click information to the server to simulate.

Each video frame is inter-compressed against the previous frame and then intra-compressed with a modified LZW scheme to minimize the amount of data transmitted from server to client.

For more detailed information on VCEP application, please refer to http://ftp.icpdas.com.tw/pub/cd/winpac_am335x/VP-X201-CE7/pc_tools/vcep/

3.5. Remote_Display

The **Remote Display** allows VP-X201-CE7 to be controlled and monitored from a remote location.

This tool is composed of two parts, a client and a server. The server is a program named cerdisp.exe running on VP-X201-CE7. The client is a PC-based program named cerhost.exe running on the PC.



cerdisp



cerhost

Once a connection is established between the client and server (initiated by the client), the client will periodically send requests for screen updates and send mouse/key click information to the server to simulate.

3.6. SendToCOM

The **SendToCOM** uses the serial port to communicate with expansion module. To use the SendToCOM, you can send data to expansion module through the serial port, and receive data from other device through the serial port.

For more information about these commands for communicating with expansion module, please refer to:

http://www.icpdas.com/root/product/solutions/remote_io/rs-485/i-8k_i-87k/i-8k_i-87k_selection.html#b

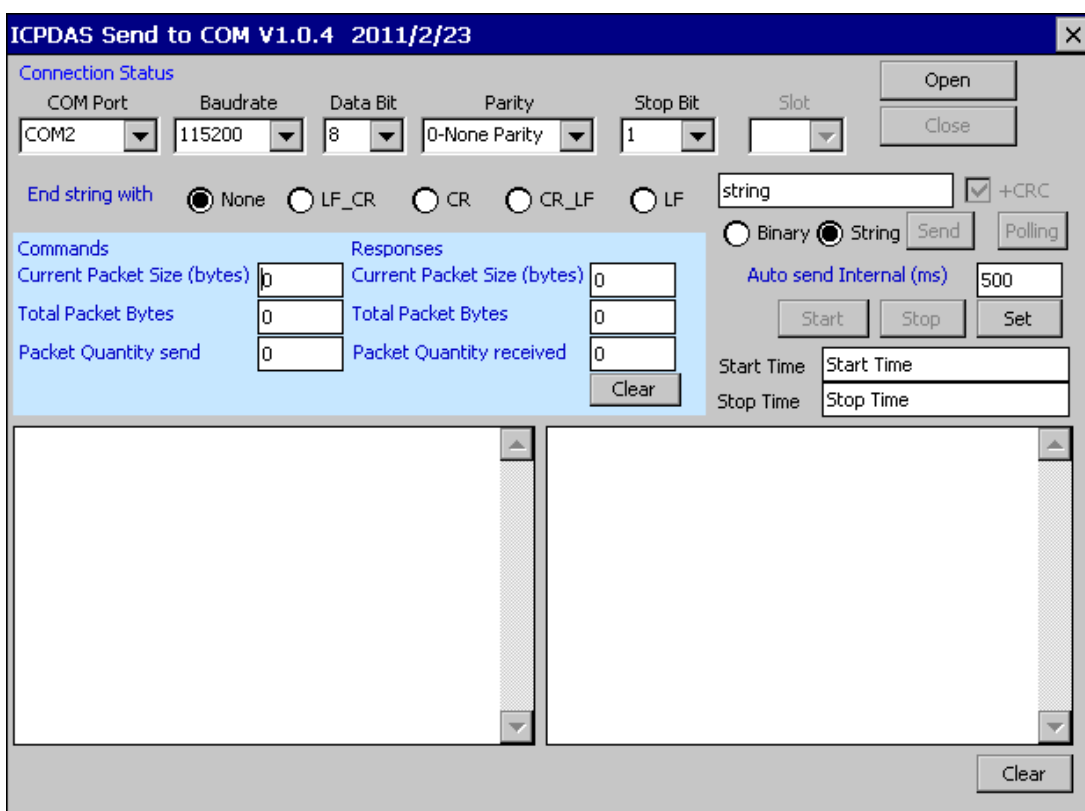

3.7. RegEdit

The **RegEdit** provides a hierarchical representation of the registry on a target computer, similar in appearance to the Windows Registry Editor. The standard registry roots are represented; you can add keys beneath a root to point to existing registry keys, or you can add your own keys. Values can be changed for existing keys, or added for new keys, and default keys can be specified. For more information, see Registry Settings Management in Deployment.

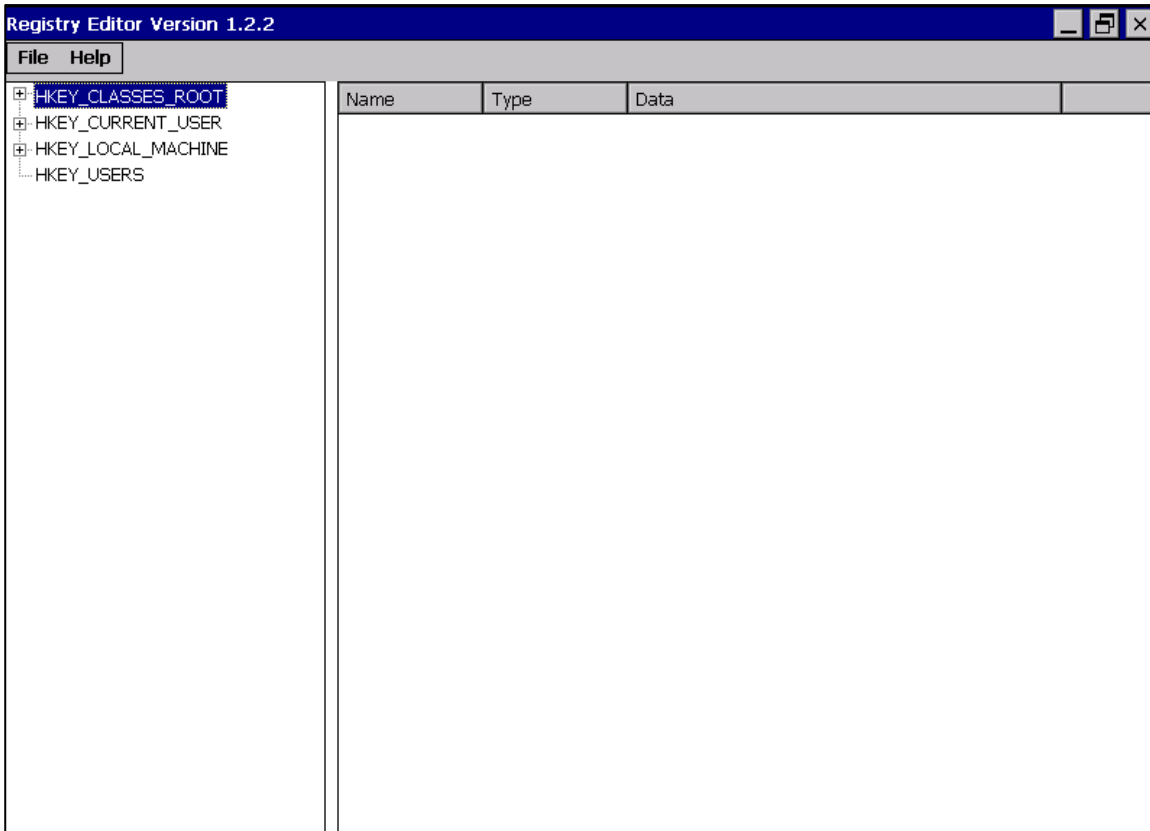

3.8. ISQLW35

The **ISQLW35** is a Windows Embedded Compact 7 functionality that implements SQL Server Compact 3.5 Query.

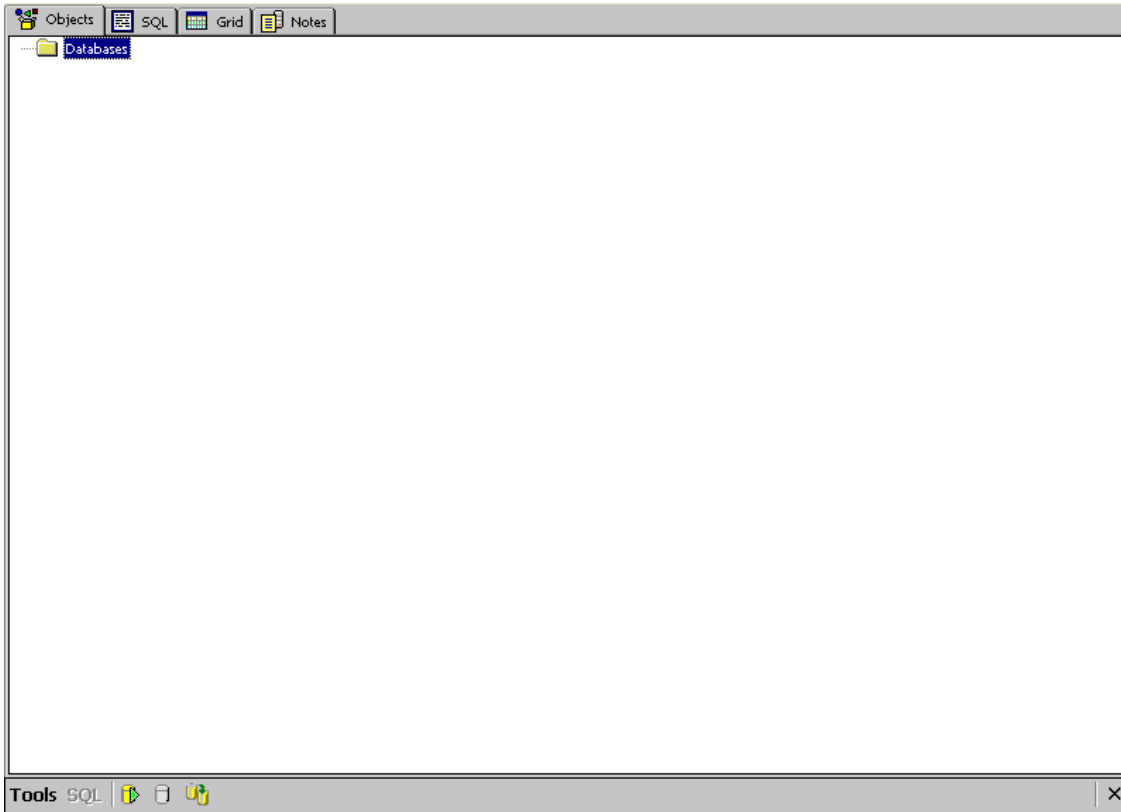

3.9. INotepad

The **INotepad** is a common text-only editor. The resulting files have no format tags or styles.

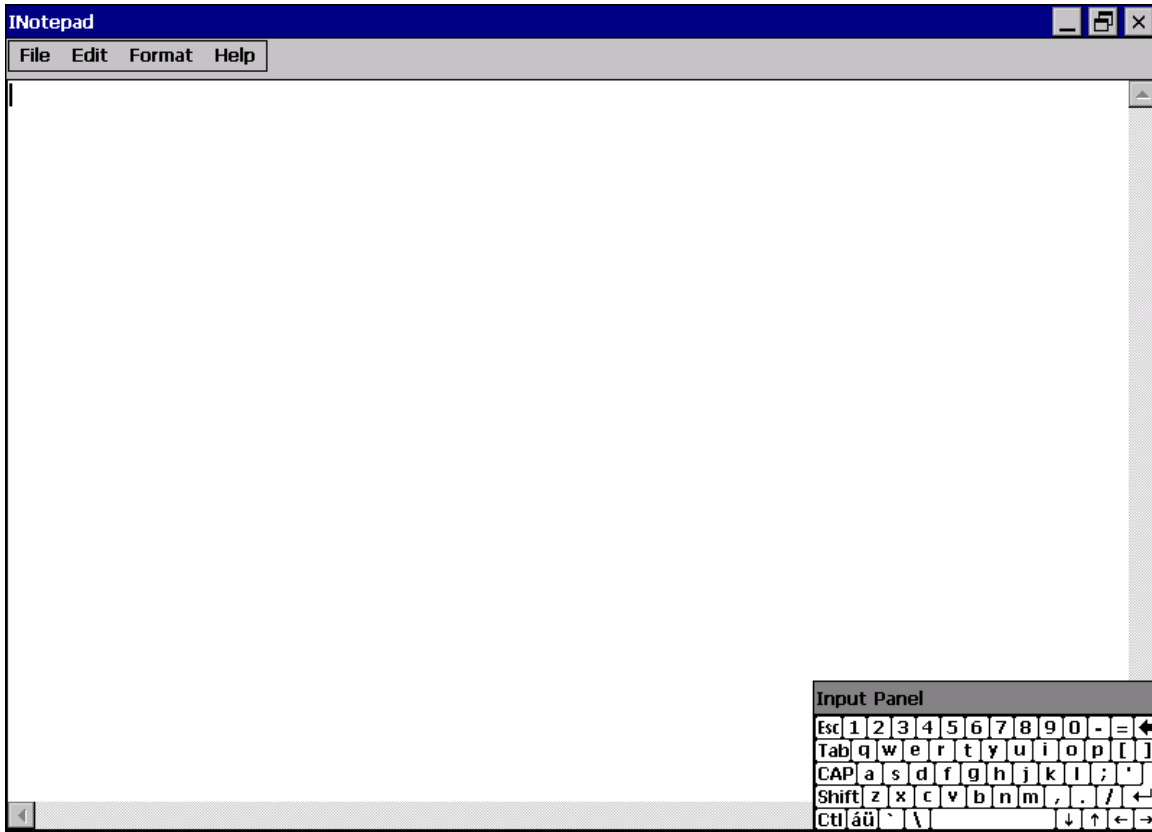

4. Your First VP-X201-CE7 Program

This chapter provides a guided tour that describes the steps needed to set-up a development environment, download, install, configure for user programming with VP-X201-CE7 modules.

4.1. Setting up the Development Environment

Before writing your first program, ensure that you have the necessary development tool and the corresponding SDKs are installed on your system.

4.1.1. Preparing the Development Tools and Programming Languages

VP-X201-CE7 is a Windows CE-based device that supports three programming languages for developing Windows CE applications.

- Visual Basic.NET
- Visual C#
- Visual C++

Development Tools

VP-X201-CE7 supports the application development with the Professional Edition application of Visual Studio 2008.



Tips & Warnings



There are some updates for Visual Studio 2008 to provide support for Windows Embedded Compact 7.

If you have Professional Edition of Visual Studio 2008 are installed, make sure all of the following package are installed

1. Visual Studio 2008 Service Pack 1

<http://www.microsoft.com/en-us/download/details.aspx?id=10986>

2. Visual Studio 2008 update for Windows Embedded Compact 7

<http://www.microsoft.com/en-us/download/confirmation.aspx?id=11935>

3. Windows Embedded Compact 7 ATL Update for Visual Studio 2008 SP1

<http://support.microsoft.com/kb/2468183/en-us>

4.1.2. Installing the VP-X201-CE7 SDK

The VP-X201-CE7 SDK offers several APIs for customizing the standard features and integrating with other applications, devices and services.

Step 1: Get the latest version of the VP-X201-CE7 SDK, AM335x_WINCE7_SDKV100B03

The VP-X201-CE7 SDK can be found from the CD that was provided with the package or by downloading the latest version from ICP DAS web site.

CD:\vp-x201\SDK\PlatformSDK\

http://ftp.icpdas.com/pub/cd/winpac_am335x/vp-x201/sdk/platformsdk/

Step 2: Execute the AM335x_WINCE7_SDK_YYYYMMDD.msi

Follow the prompts until the installation process is complete.

Step 3: Execute the VisualStudioDeviceWindowsEmbeddedCompact7

Follow the prompts until the installation process is complete.

4.1.3. Setting up the Global Compiler Settings (for Visual C++)

The directories can be specified where the compiler will search for include files and libraries.

Step 1: Start Visual Studio 2008



Step 2: On the Tools menu, click Options...

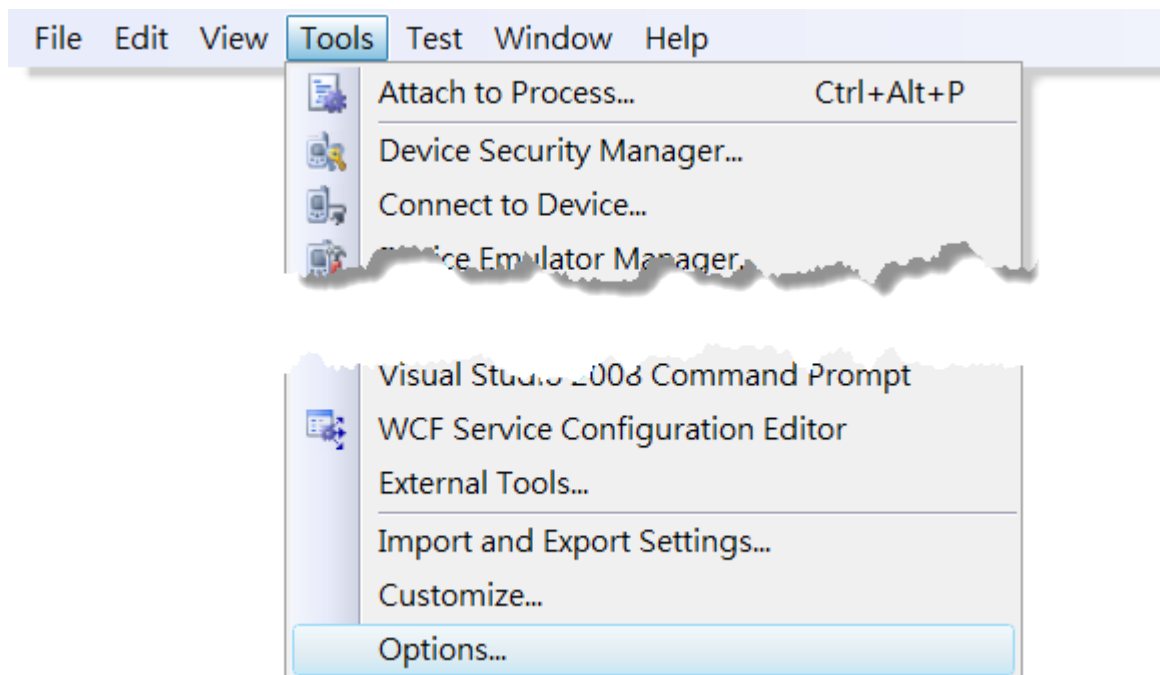

Step 3: In the Options dialog box, expand the Projects folder, and then then click the VC++ Directories

Step 4: In the Show directories for: drop-down list, select Include files

Step 5: Use the buttons in the Options dialog box to add additional include paths

The path of “\$(VCInstallDir)ce7\include” and “\$(VCInstallDir)ce7\atlmfc\include” must be moved to the top of the list.

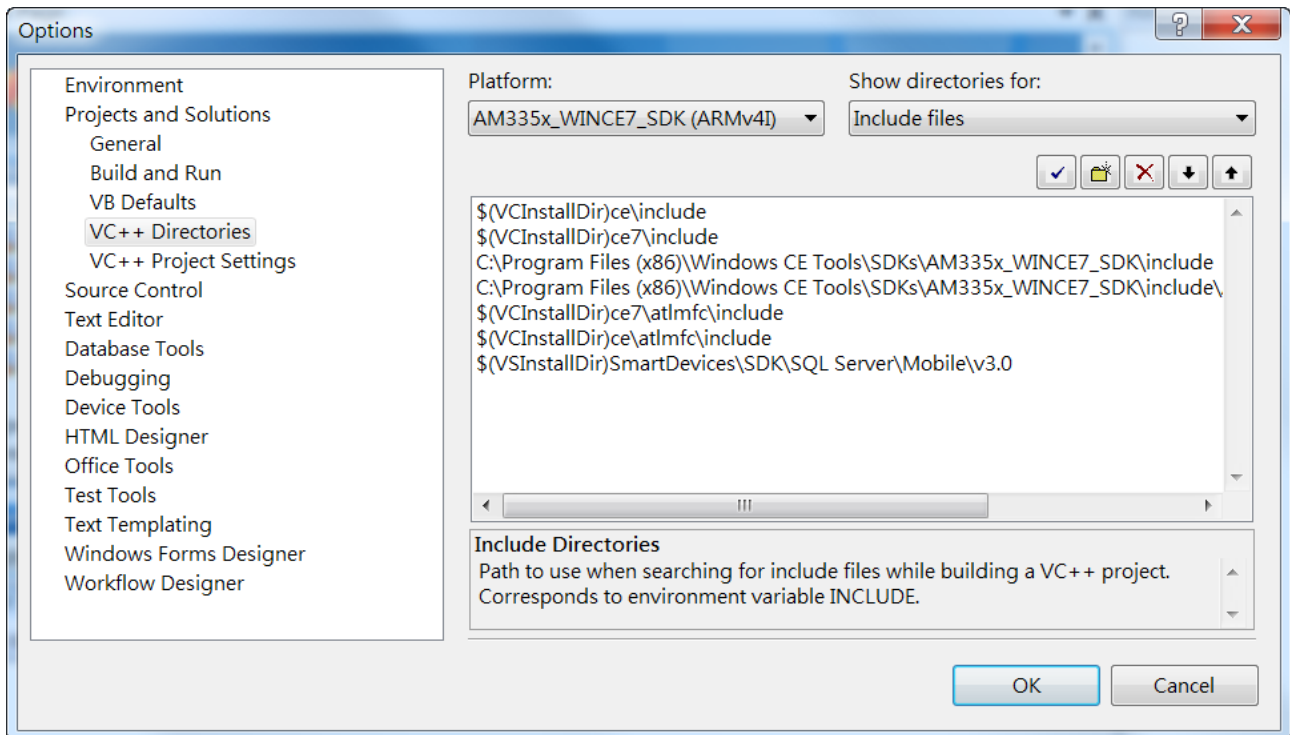

4.2. First VP-X201-CE7 Program in VB.NET

The best way to learn programming with VP-X201-CE7 is to actually create a VP-X201-CE7 program.

The example below demonstrates how to create a demo program running on VP-X201-CE7 with VB.NET.

To create a demo program with VB.NET that includes the following main steps:

1. Create a new project
2. Specify the path of the PAC reference
3. Add the control to the form
4. Add the event handling for the control
5. Upload the application to VP-X201-CE7
6. Execute the application on VP-X201-CE7

All main steps will be described in the following subsection.

In this tutorial, we will assume that you have installed VP-X201-CE7 SDK on PC and used the Visual Studio 2008 for application development.

4.2.1. Create a new project

The Visual VB.net project template is a composite control that you use in this example creates a new project with this user control.

Step 1: Start Visual Studio 2008



Step 2: On the File menu, point to New, and then click Project

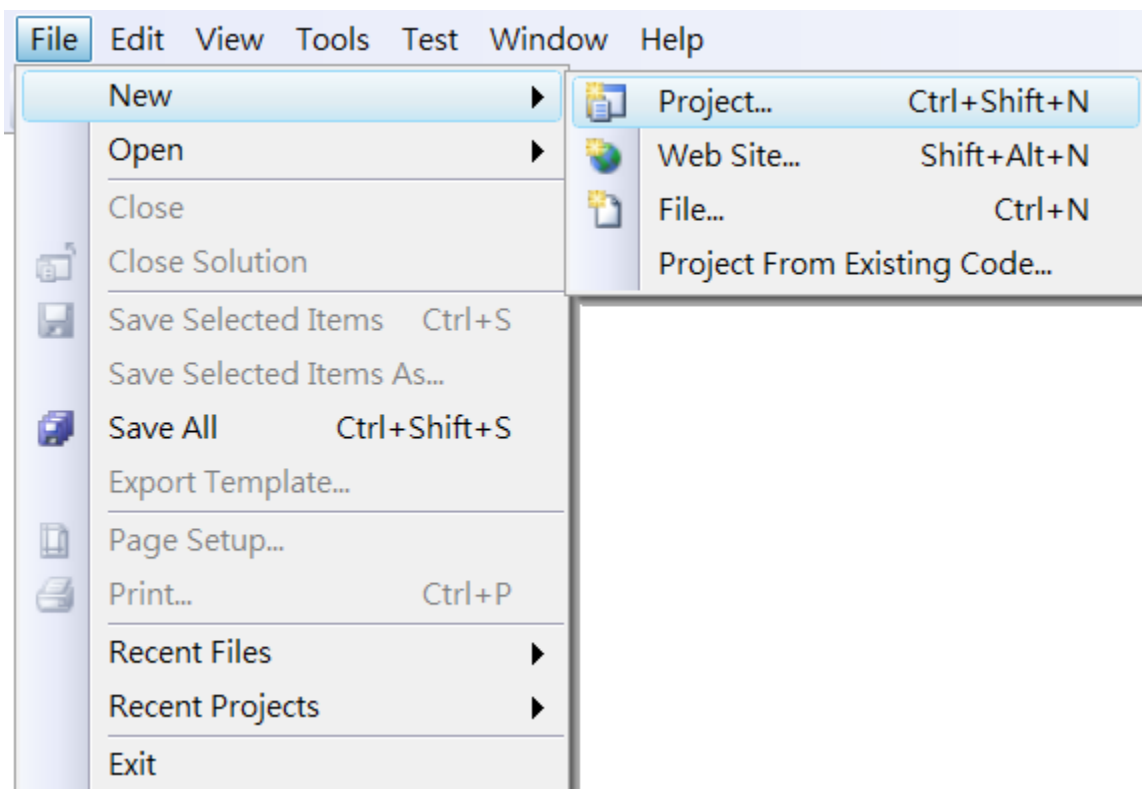

Step 3: In the Project types pane, expand Visual Basic node and select Smart Device

Step 4: In the list of Templates, select Smart Device Project

Step 5: Specify a name and a location for the application and then click OK

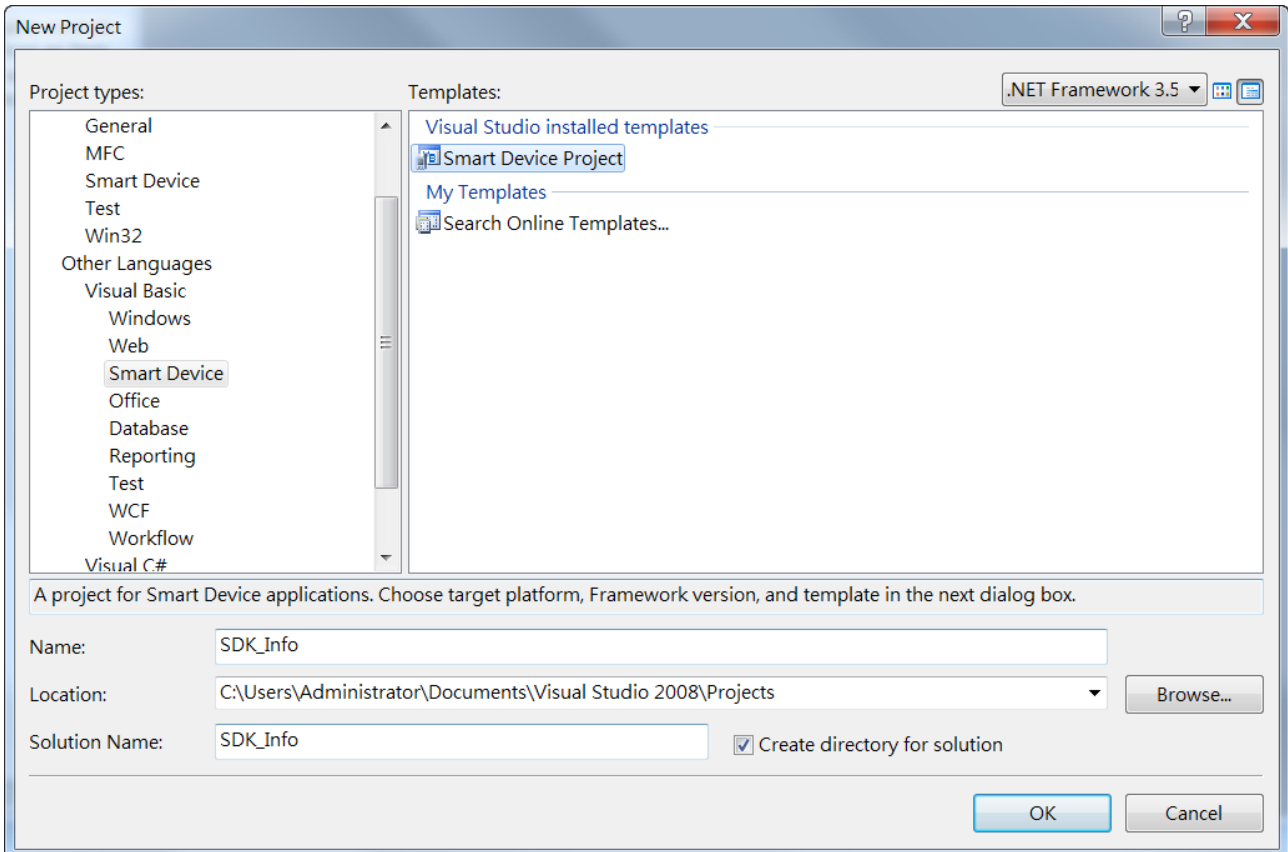

Step 6: In the Target platform, select Windows CE

Step 7: In the .NET Compact Framework version, select .NET Compact Framework Version 3.5.

Tips & Warnings



Windows CE7 only supports .NET Compact Framework Version 3.5, if your application uses .NET Compact Framework Version 2.0 there is no guarantee that the program will function correctly.

Step 8: In the list of templates, select Device Application. Click OK

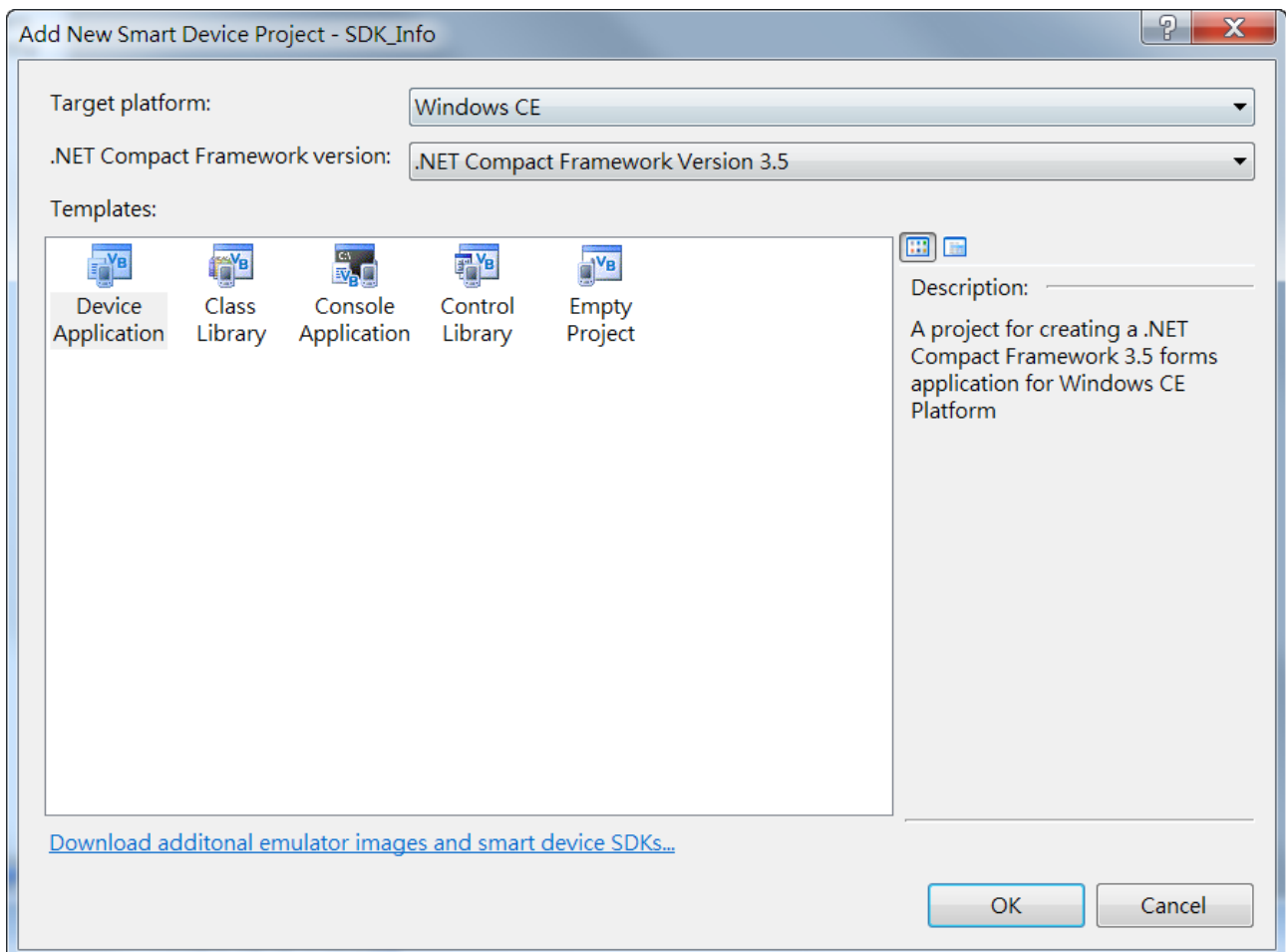

4.2.2. Specify the path of the PAC reference

The PAC SDK provides a complete solution to integrate with VP-X201-CE7 and it's compatible with Visual C#, Visual Basic.NET and C++. In order to use a component in your application, you must first add a reference to it.

Step1: Get the PACNET.dll



The PACNET.dll can be found from the CD that was provided with the package or by downloading the latest version from ICP DAS web site.

CD:\vp-x201\SDK\PACNET\

http://ftp.icpdas.com/pub/cd/winpac_am335x/vp-x201/sdk/pacnet/

Step 2: On the Project menu, and then click Add Reference...

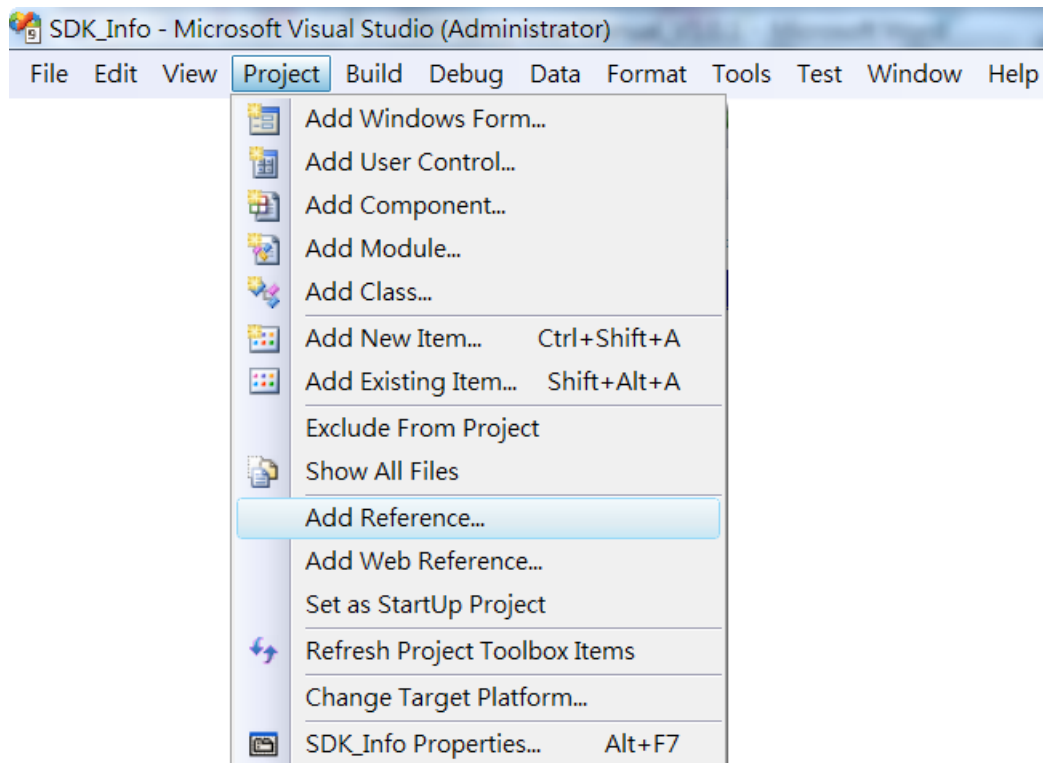

Step 3: On the Browse tab and browse to where the PACNET.dll are installed, and then click OK

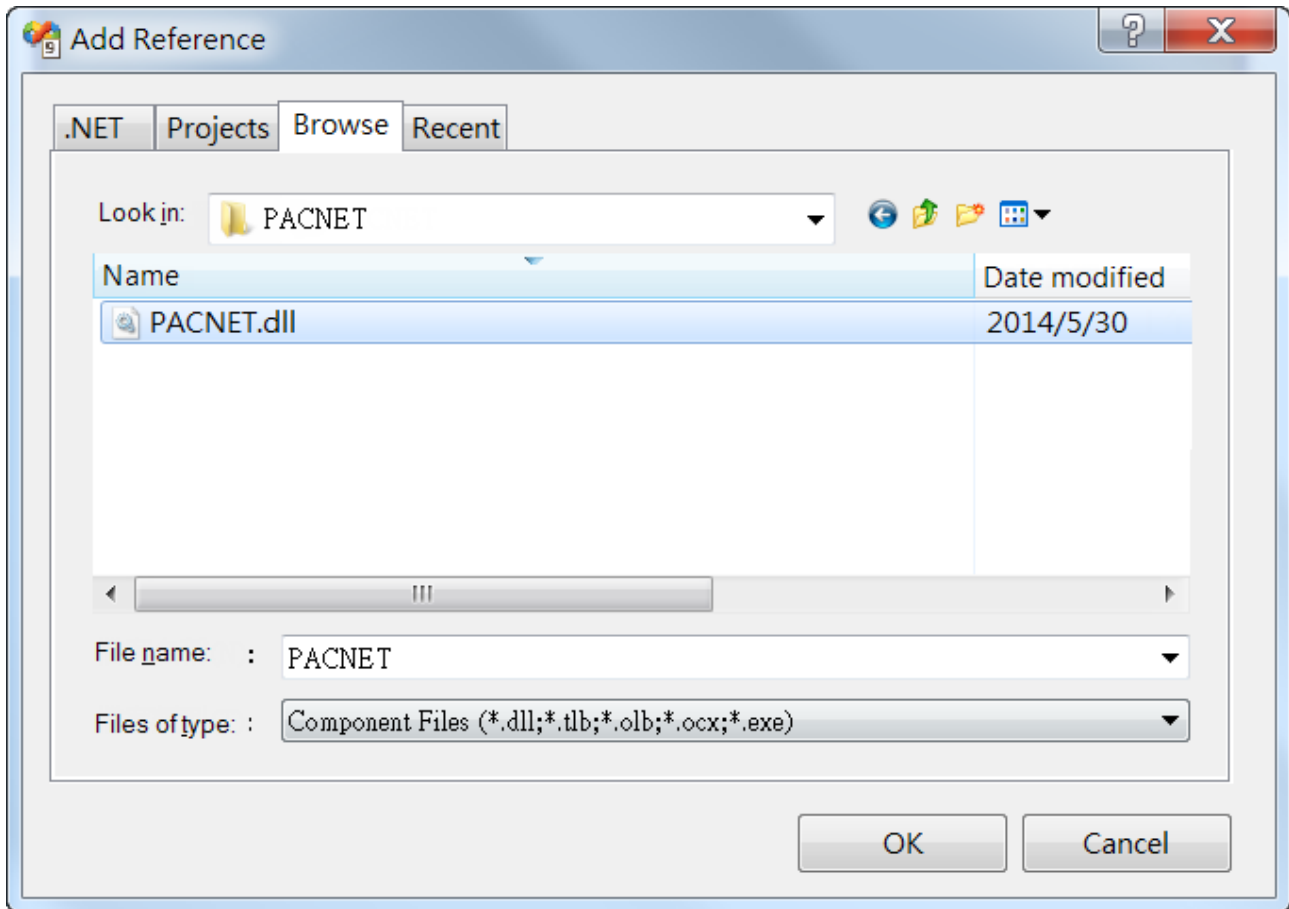

4.2.3. Add the control to the form

You can drag various controls from the Toolbox onto the form. These controls are not really "live"; they are just images that are convenient to move around on the form into a precise location.

After you add a control to your form, you can use the Properties window to set its properties, such as background color and default text. The values that you specify in the Properties window are the initial values that will be assigned to that property when the control is created at run time.

Step 1: On the Toolbox panel, drag a Button control onto the form

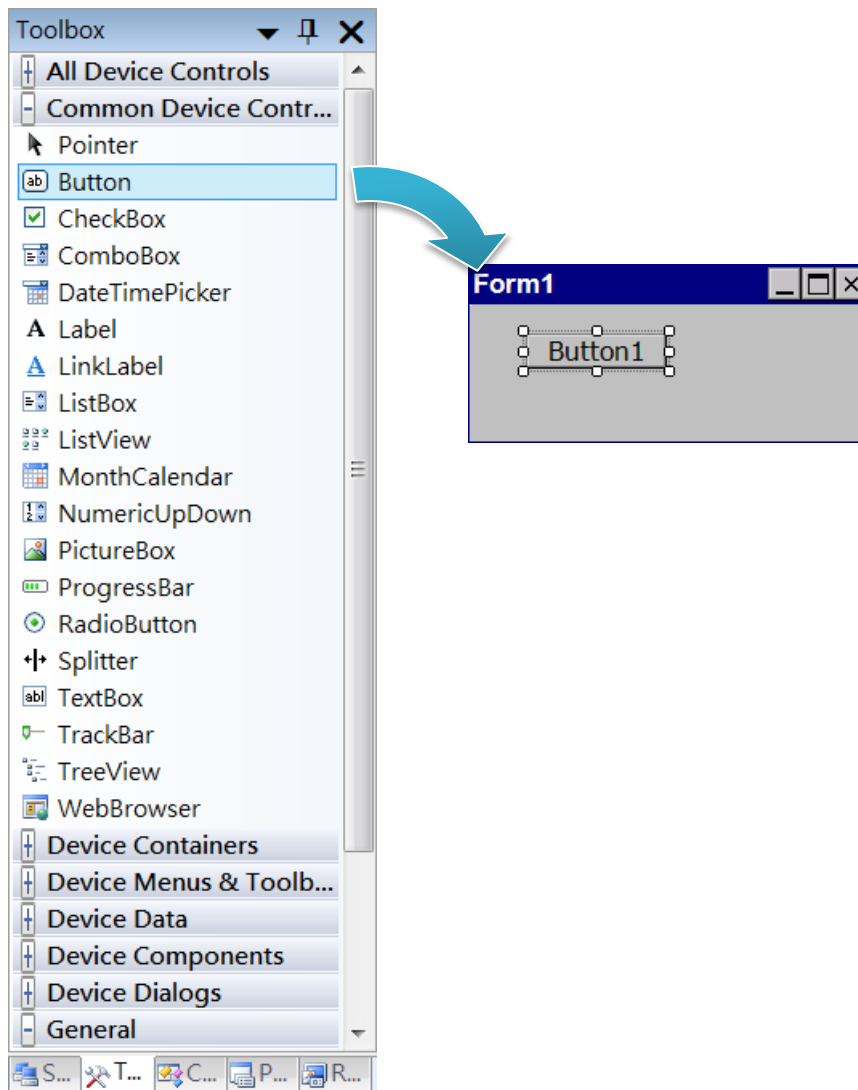

Step 2: On the Properties panel, type Check the SDK version in the Text field

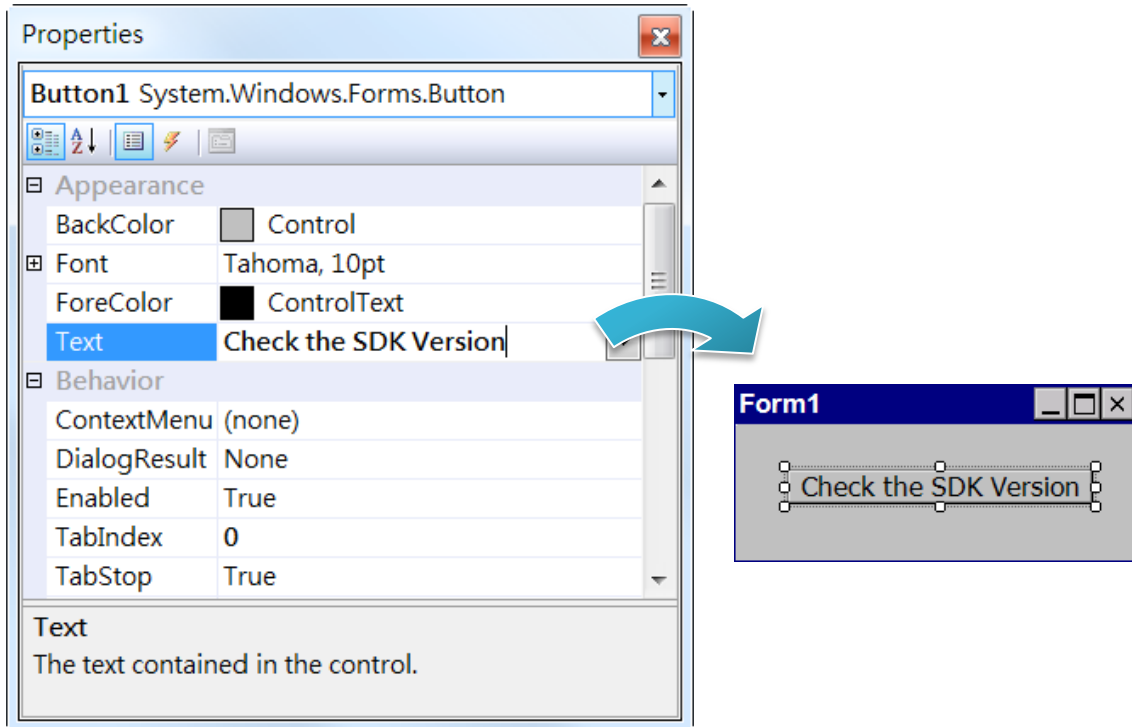

4.2.4. Add the event handling for the control

You have finished the design stage of your application and are at the point when you can start adding some code to provide the program's functionality.

Step 1: Double-click the button on the form

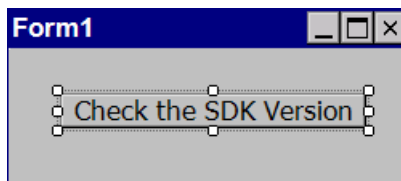

Step 2: Inserting the following code

```
Dim data(30) As Byte
PACNET.Sys.GetSDKVersion(data)
MessageBox.Show(PACNET.MISC.WideString(data))
```

```
Public Class Form1
    Private Sub Button1_Click(ByVal sender As System.Object, ByVal e As EventArgs)
        Dim data(30) As Byte
        PACNET.Sys.GetSDKVersion(data)
        MessageBox.Show(PACNET.MISC.WideString(data))
    End Sub
End Class
```

Tips & Warnings



The "PACNET" of "using PACNET" is case-sensitive.

4.2.5. Upload the application to VP-X201-CE7

VP-X201-CE7 supports FTP server service. You can upload files to VP-X201-CE7 or download files from a public FTP server.



Step 1: On the Build menu, and then click Build [Project Name]

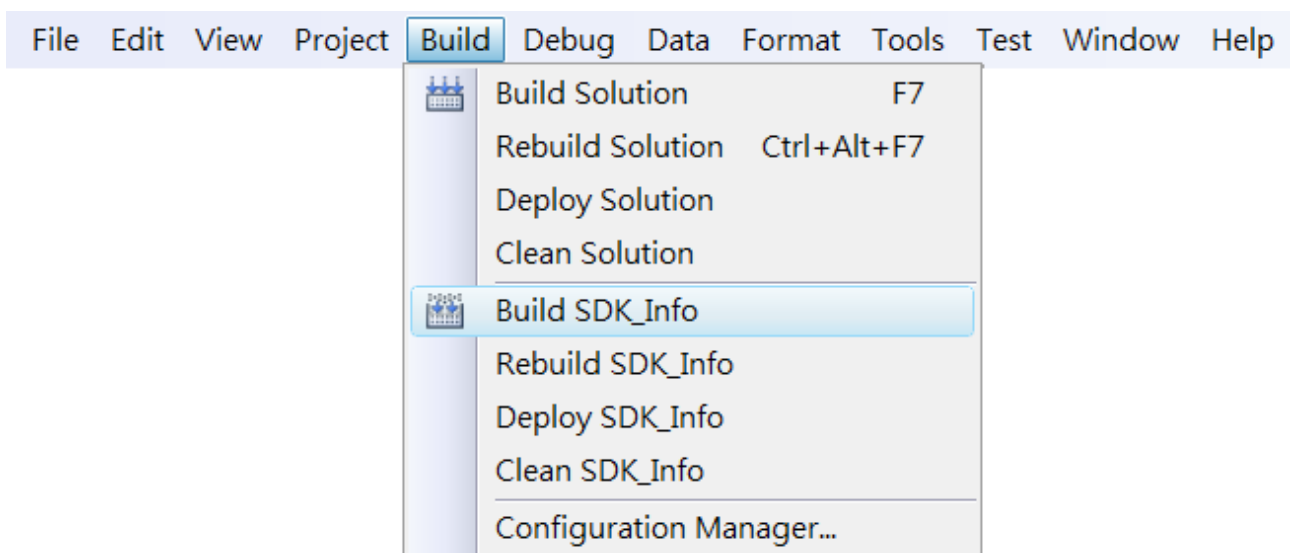

Step 2: Open the browser and type the IP address of VP-X201-CE7

Step 3: Upload the application and the corresponding PACNET.dll files to VP-X201-CE7

Tips & Warnings



For applications programming in C# and VB.net with .net compact framework, when executing these application on VP-X201-CE7, the corresponding PACNET.dll must be in the same directory as the .exe file.

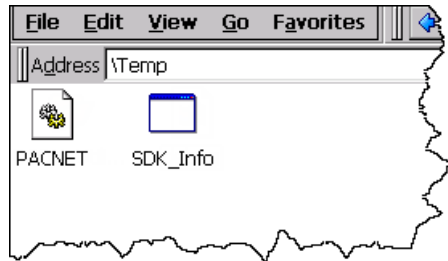

4.2.6. Execute the application on VP-X201-CE7

After uploading the application to VP-X201-CE7, you can just double-click it on VP-X201-CE7 to execute it.

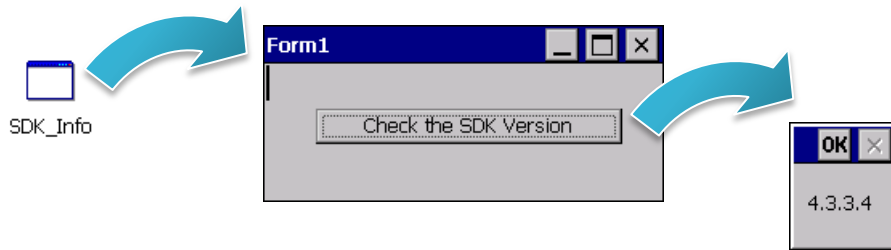

4.3. First VP-X201-CE7 Program in Visual C#

The best way to learn programming with VP-X201-CE7 is to actually create a VP-X201-CE7 program.

The example below demonstrates how to create a demo program running on VP-X201-CE7 with Visual C#.

To create a demo program with Visual C# that includes the following main steps:

1. Create a new project
2. Specify the path of the PAC reference
3. Add the control to the form
4. Add the event handling for the control
5. Upload the application to VP-X201-CE7
6. Execute the application on VP-X201-CE7

All main steps will be described in the following subsection.

In this tutorial, we will assume that you have installed VP-X201-CE7 SDK on PC and used the Visual Studio 2008 for application development.

4.3.1. Create a new project

The Visual C# project template is a composite control that you use in this example creates a new project with this user control.

Step 1: Start Visual Studio 2008



Step 2: On the File menu, point to New, and then click Project

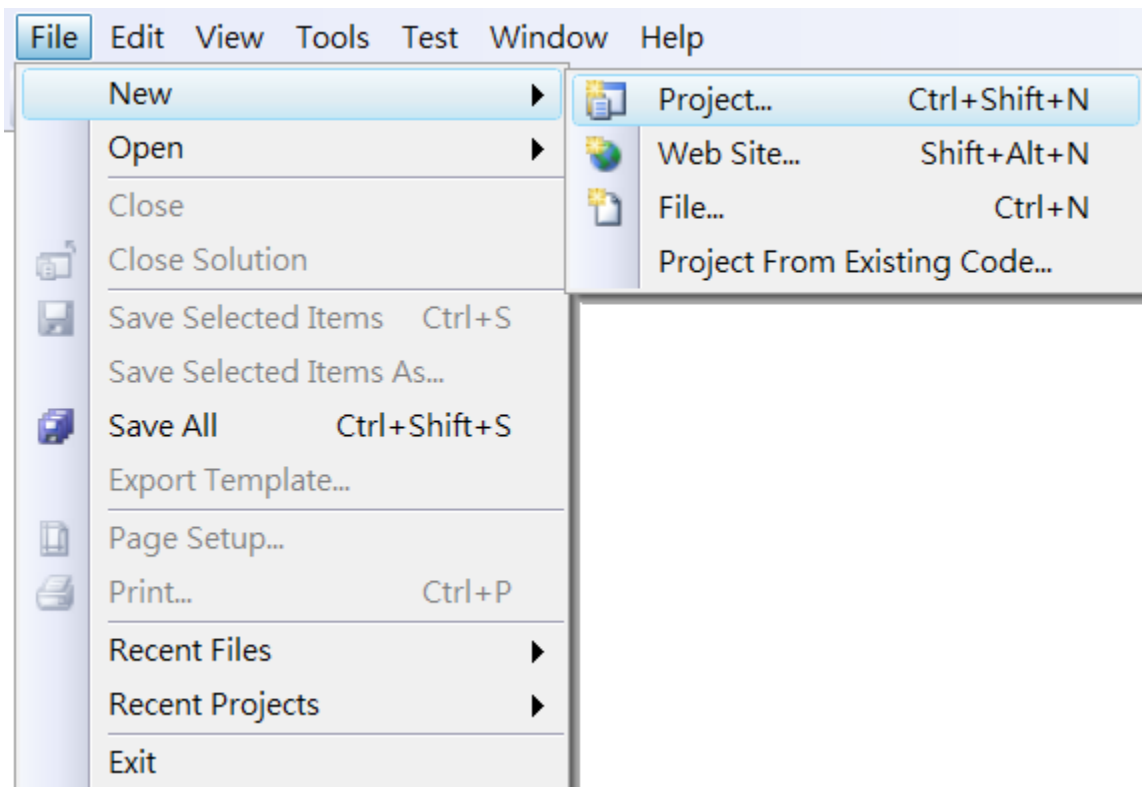

Step 3: In the Project types pane, expand Visual C# node and select Smart Device

Step 4: In the list of Templates, select Smart Device Project

Step 5: Specify a name and a location for the application and then click OK

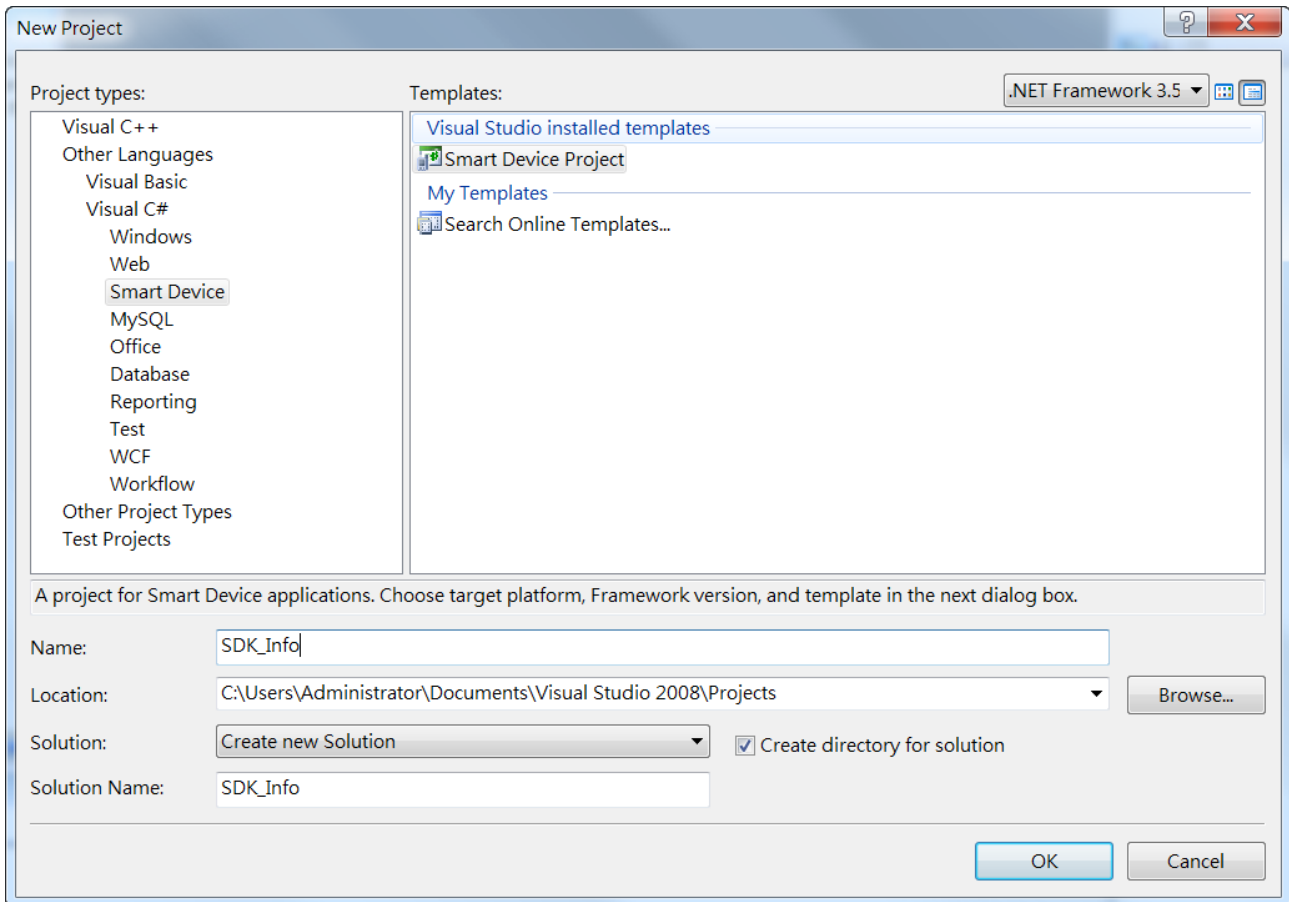

Step 6: In the Target platform, select Windows CE

Step 7: In the .NET Compact Framework version, select .NET Compact Framework Version 3.5.

Tips & Warnings



Windows CE7 only supports .NET Compact Framework Version 3.5, if your application uses .NET Compact Framework Version 2.0 there is no guarantee that the program will function correctly.

Step 8: In the list of templates, select Device Application. Click OK

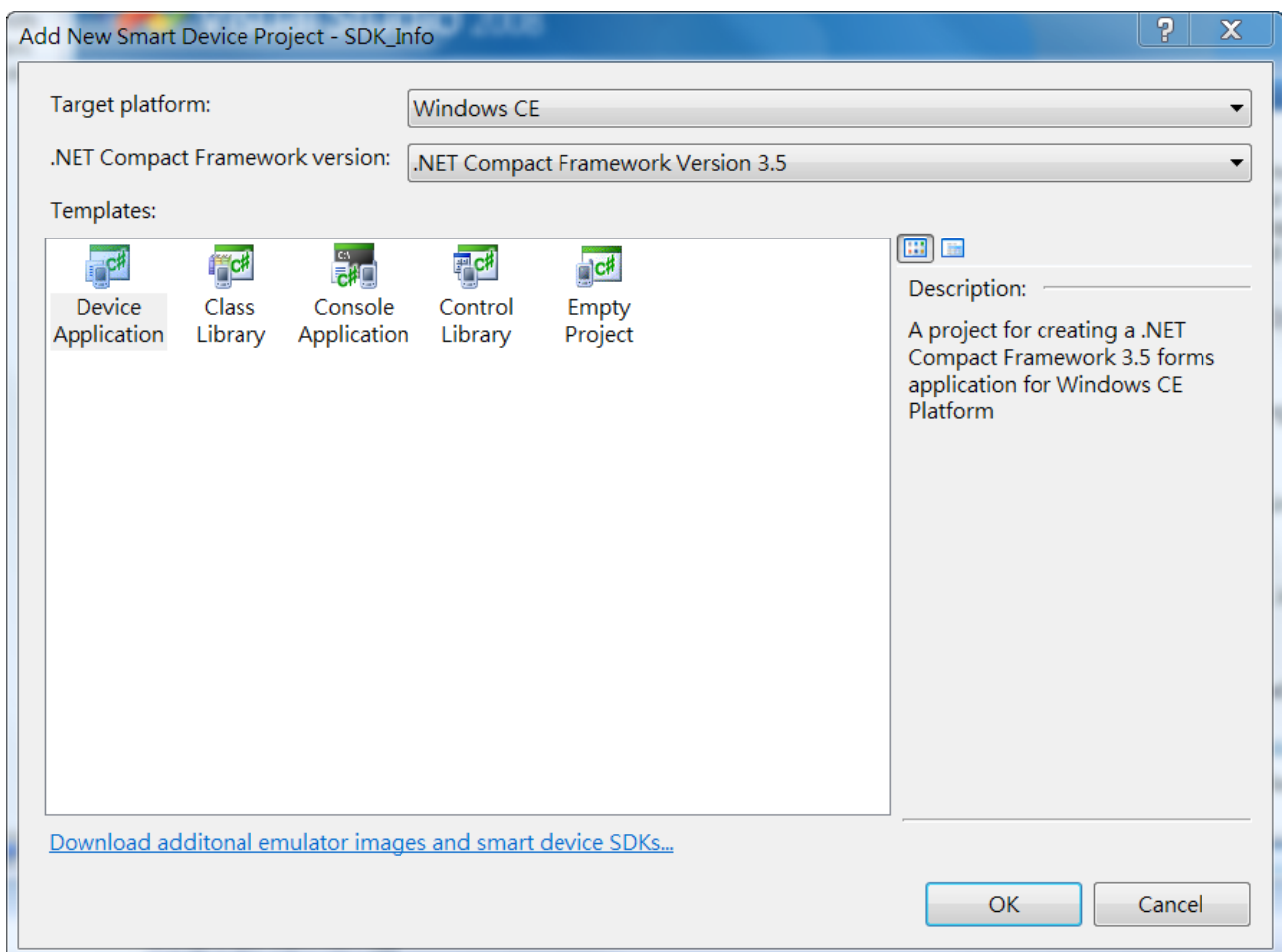

4.3.2. Specify the path of the PAC reference

The PAC SDK provides a complete solution to integrate with VP-X201-CE7 and it's compatible with Visual C#, Visual Basic.NET and C++. In order to use a component in your application, you must first add a reference to it.

Step1: Get the PACNET.dll



The PACNET.dll can be found from the CD that was provided with the package or by downloading the latest version from ICP DAS web site.

CD:\vp-x201\SDK\PACNET\

http://ftp.icpdas.com/pub/cd/winpac_am335x/vp-x201/sdk/pacnet/

Step 2: On the Project menu, and then click Add Reference...

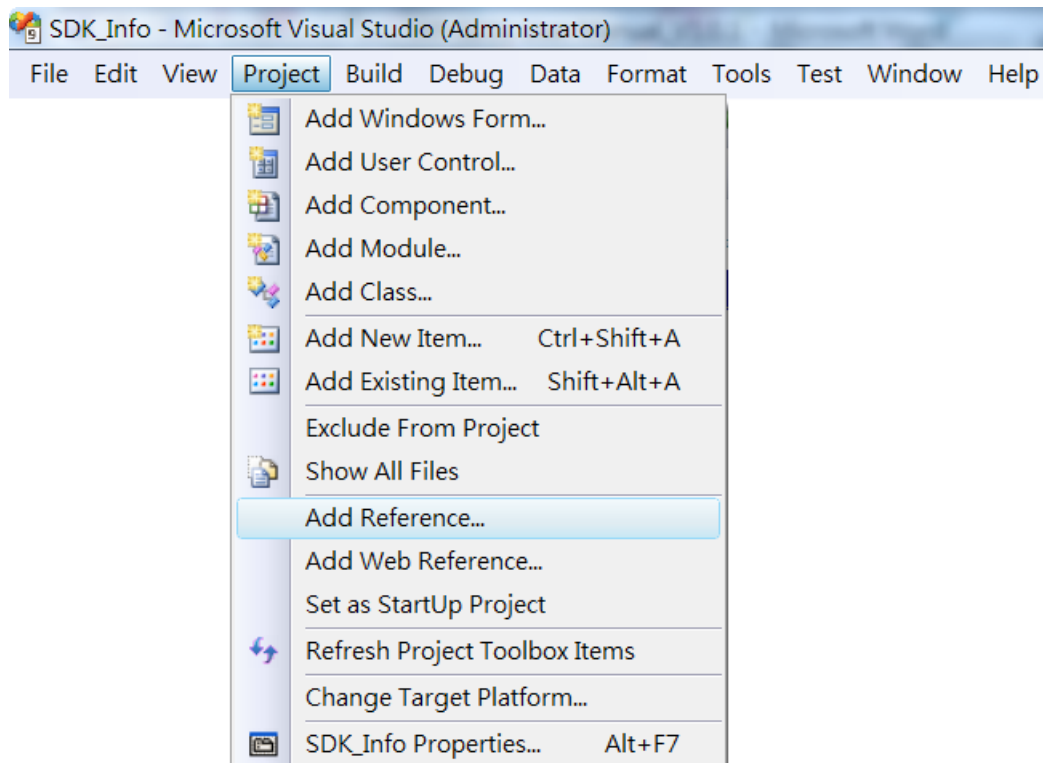

Step 3: On the Browse tab and browse to where the PACNET.dll are installed, and then click OK

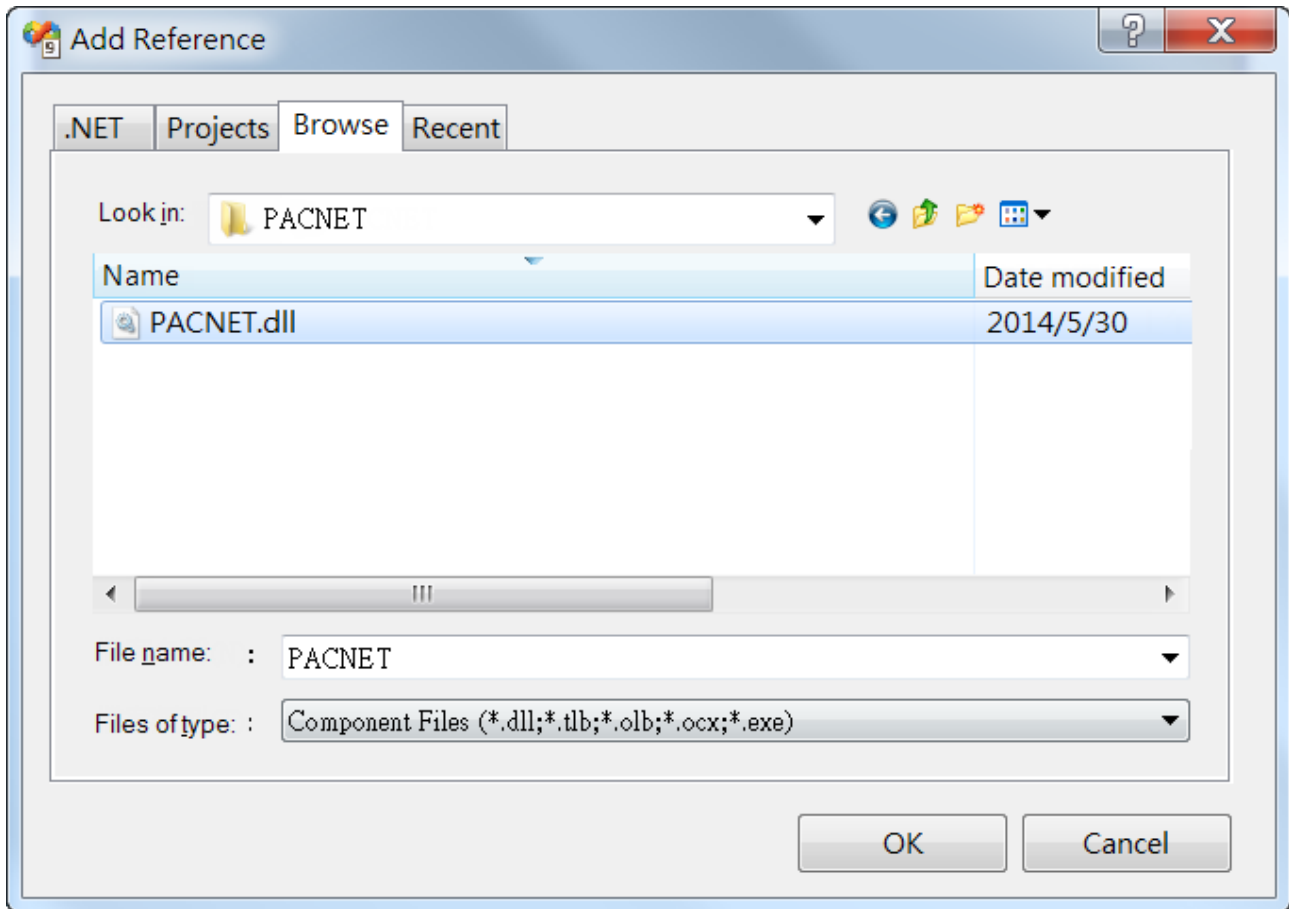

4.3.3. Add the control to the form

You can drag various controls from the Toolbox onto the form. These controls are not really "live"; they are just images that are convenient to move around on the form into a precise location.

After you add a control to your form, you can use the Properties window to set its properties, such as background color and default text. The values that you specify in the Properties window are the initial values that will be assigned to that property when the control is created at run time.

Step 1: On the Toolbox panel, drag a Button control onto the form

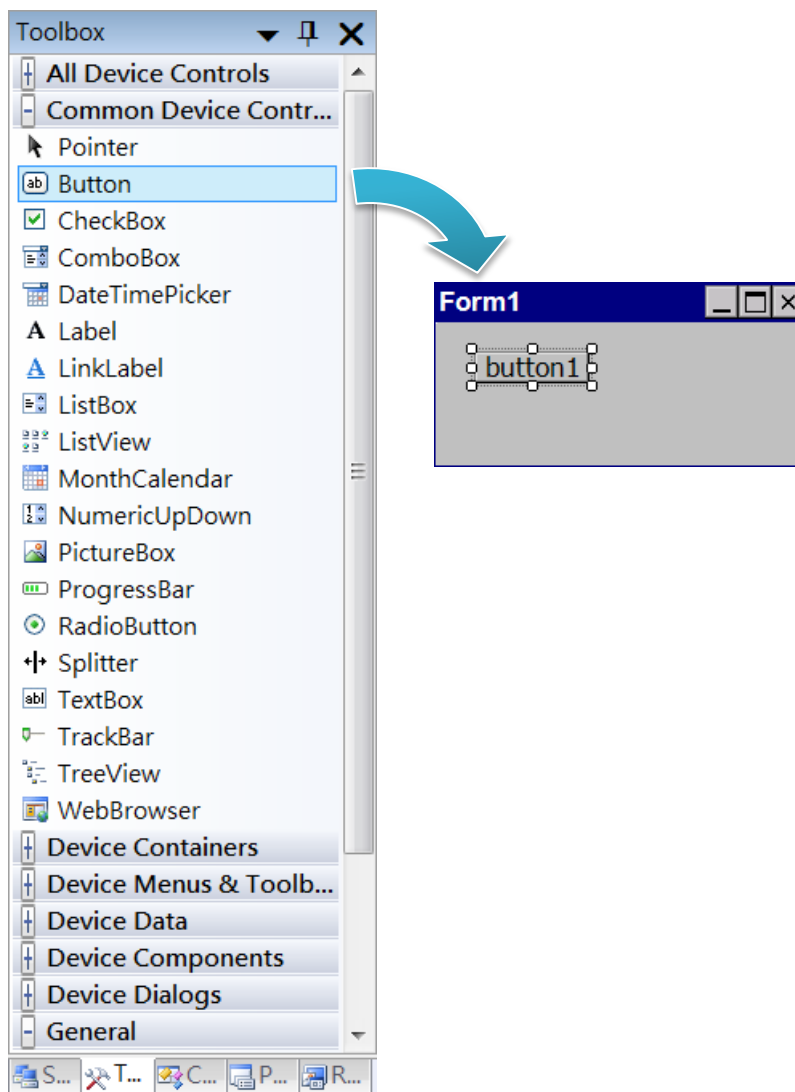

Step 2: On the Properties panel, type Check the SDK version in the Text field

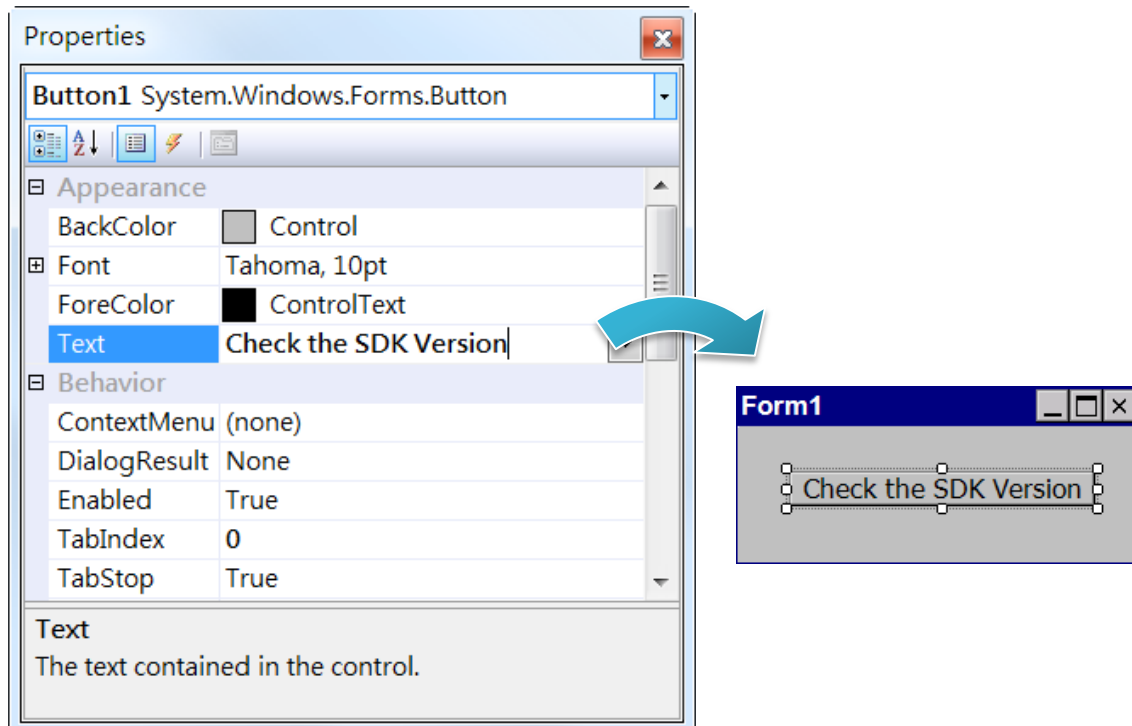

4.3.4. Add the event handling for the control

You have finished the design stage of your application and are at the point when you can start adding some code to provide the program's functionality.

Step 1: Double-click the button on the form

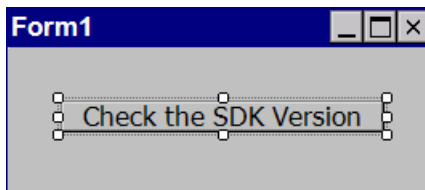

Step 2: Inserting the following code

```
byte[] data = new byte[30];  
PACNET.Sys.GetSDKVersion(data);  
MessageBox.Show(PACNET.MISC.WideString(data));
```

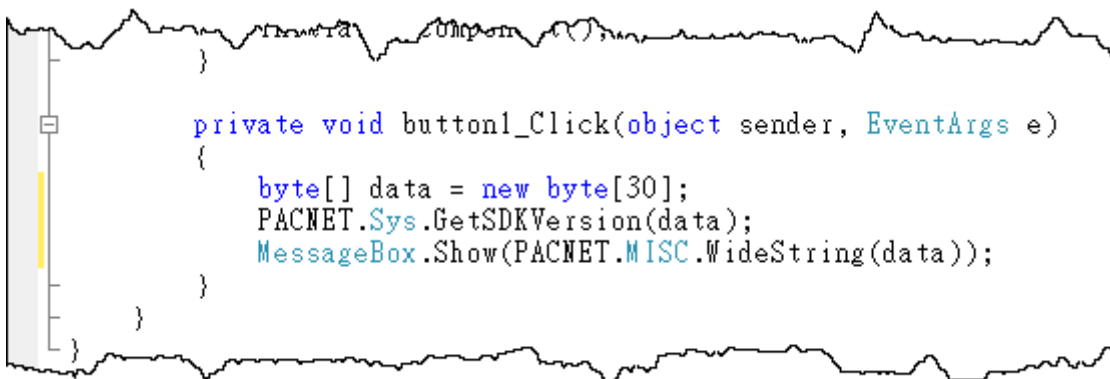

Tips & Warnings



The "PACNET" of "using PACNET" is case-sensitive.

4.3.5. Upload the application to VP-X201-CE7

VP-X201-CE7 supports FTP server service. You can upload files to VP-X201-CE7 or download files from a public FTP server.

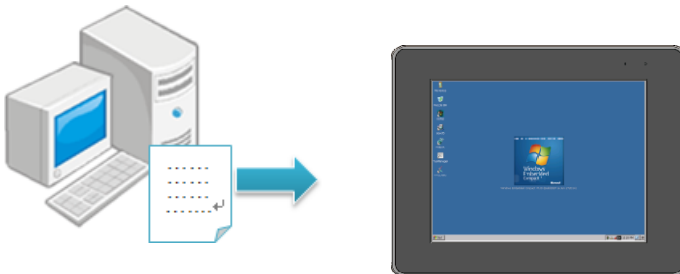

Step 1: On the Build menu, and then click Build [Project Name]

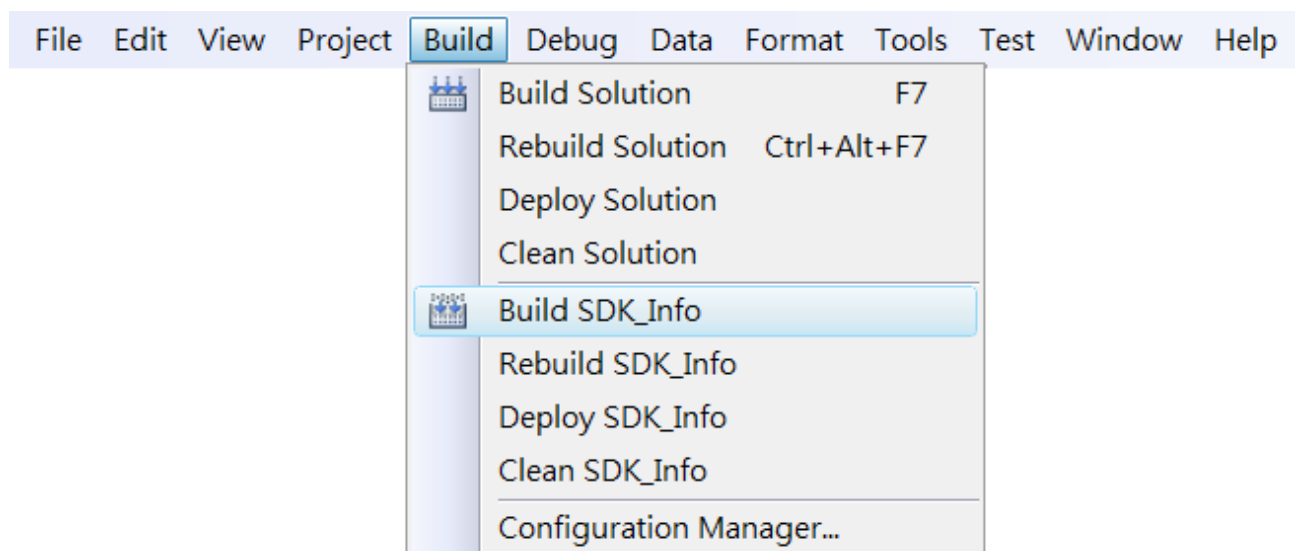

Step 2: Open the browser and type the IP address of VP-X201-CE7

Step 3: Upload the application and the corresponding PACNET.dll files to VP-X201-CE7

Tips & Warnings



For applications programming in C# and VB.net with .net compact framework, when executing these application on VP-X201-CE7, the corresponding PACNET.dll must be in the same directory as the .exe file.

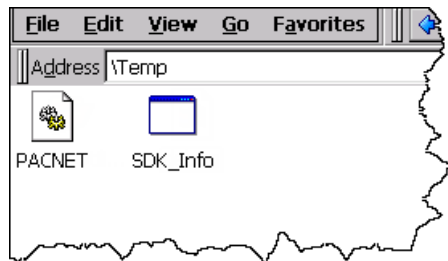

4.3.6. Execute the application on VP-X201-CE7

After uploading the application to VP-X201-CE7, you can just double-click it on VP-X201-CE7 to execute it.

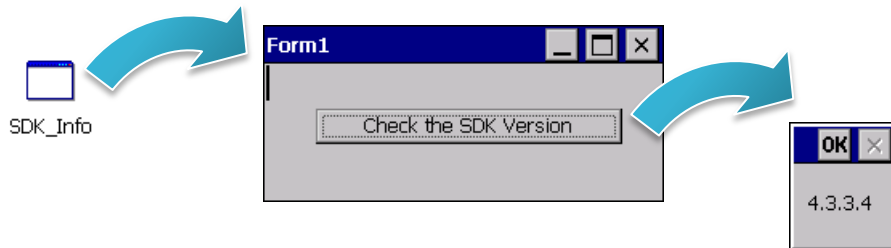

4.4. First VP-X201-CE7 Program in Visual C++

The best way to learn programming with VP-X201-CE7 is to actually create a VP-X201-CE7 program.

The example below demonstrates how to create a demo program running on VP-X201-CE7 with Visual C++.

To create a demo program with Visual C# that includes the following main steps:

1. Create a new project
2. Configure the Platform
3. Specify the path of the PAC reference
4. Add the control to the form
5. Add the event handling for the control
6. Upload the application to VP-X201-CE7
7. Execute the application on VP-X201-CE7

All main steps will be described in the following subsection.

In this tutorial, we will assume that you have installed VP-X201-CE7 SDK on PC and used the Visual Studio 2008 for application development.

4.4.1. Create a new project

The Visual C# project template is a composite control that you use in this example creates a new project with this user control.

Step 1: Start Visual Studio 2008



Step 2: On the File menu, point to New, and then click Project

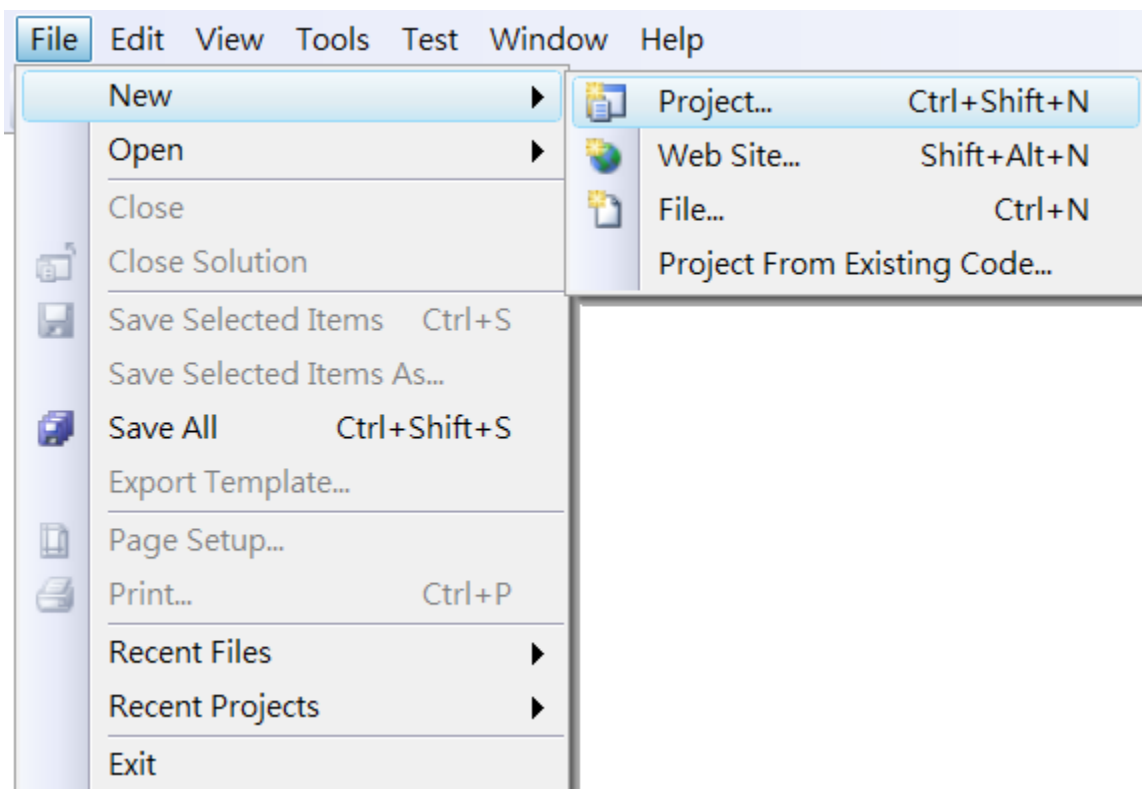

Step 3: In the Project types pane, expand Visual C++ node and select Smart Device

Step 4: In the list of Templates, select MFC Smart Device Application

Step 5: Specify a name and a location for the application and then click OK

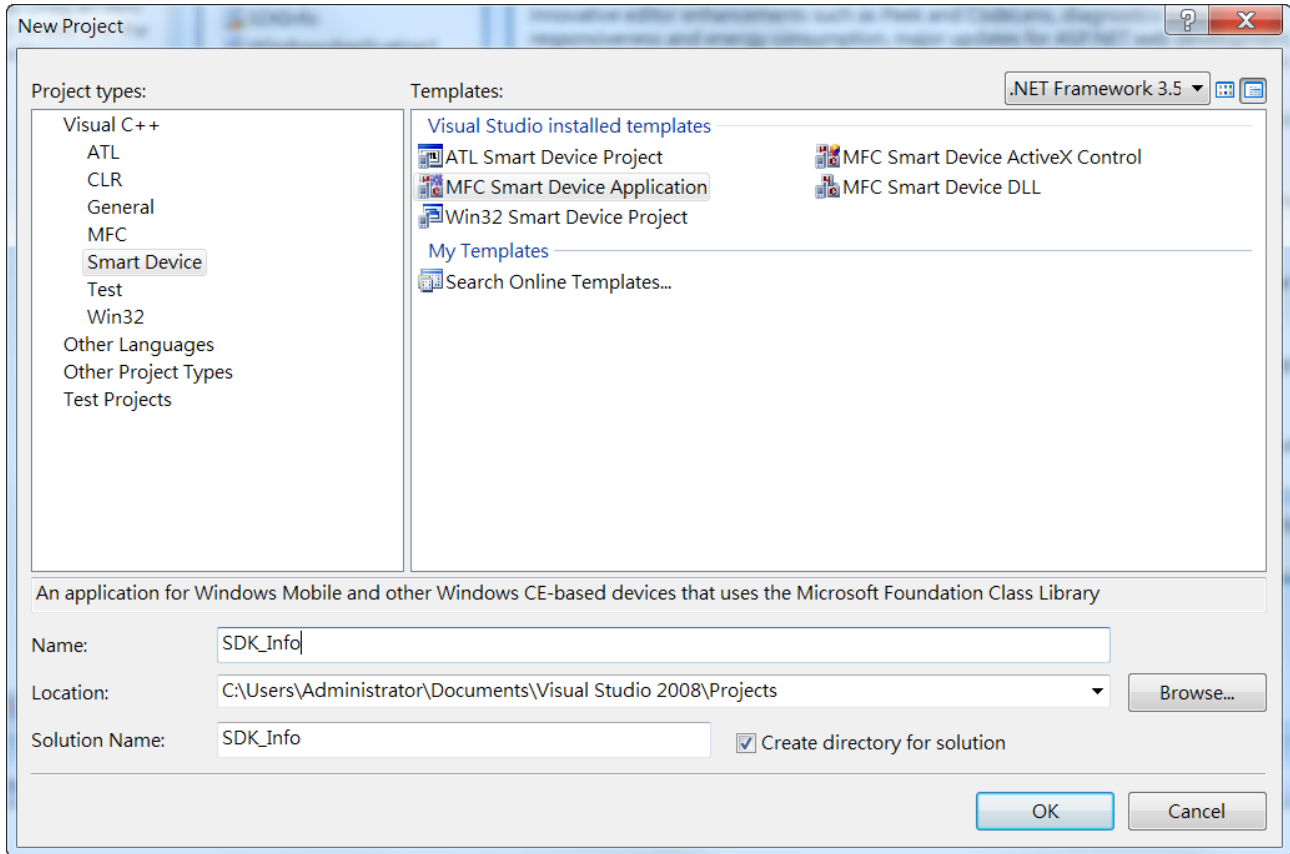

Step 6: On the first page of the wizard, click Next

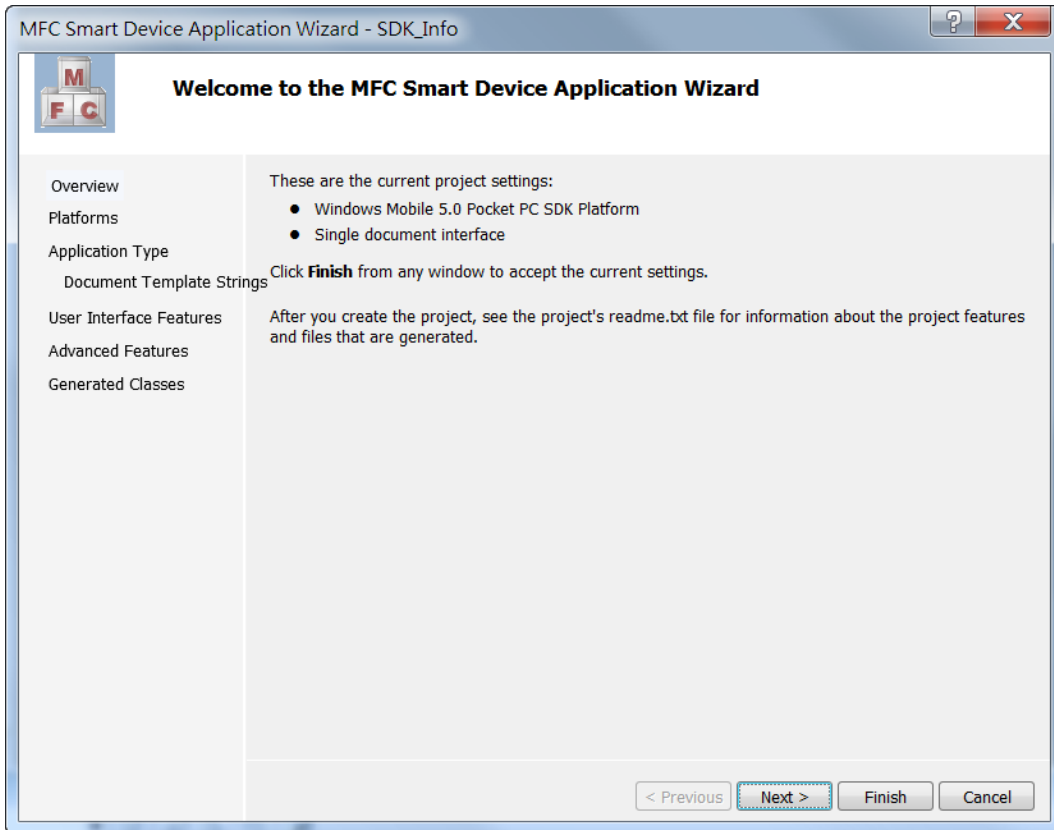

Step 7: On the next page of the wizard, select AM335x_WINCE7_SDK to be added to the project, and then click Next

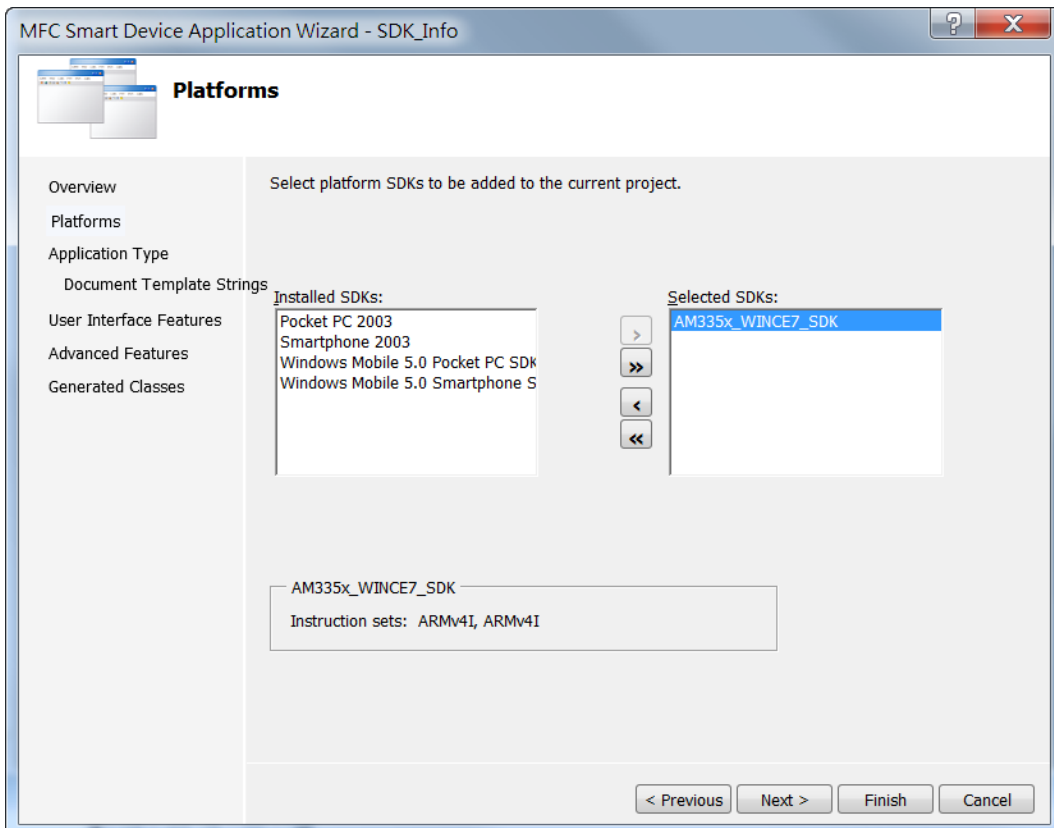

Step 8: On the next page of the wizard, select Dialog based, and then click next

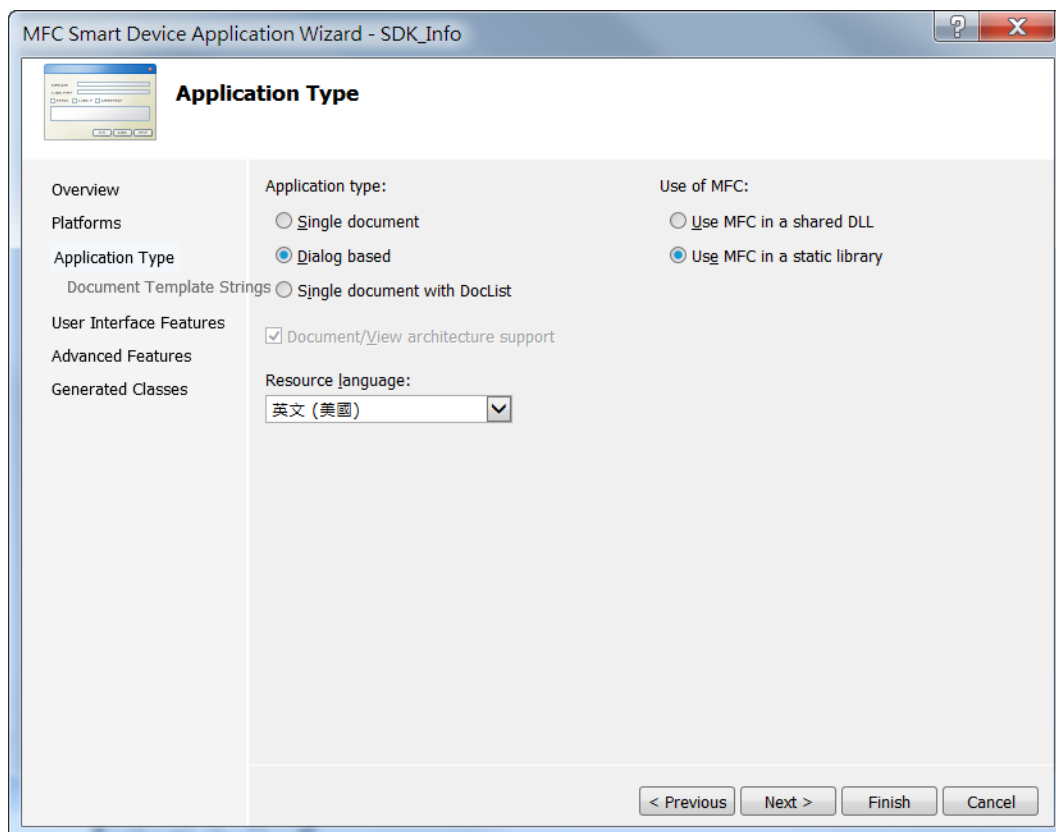

Step 9: On the next page of the wizard, click next

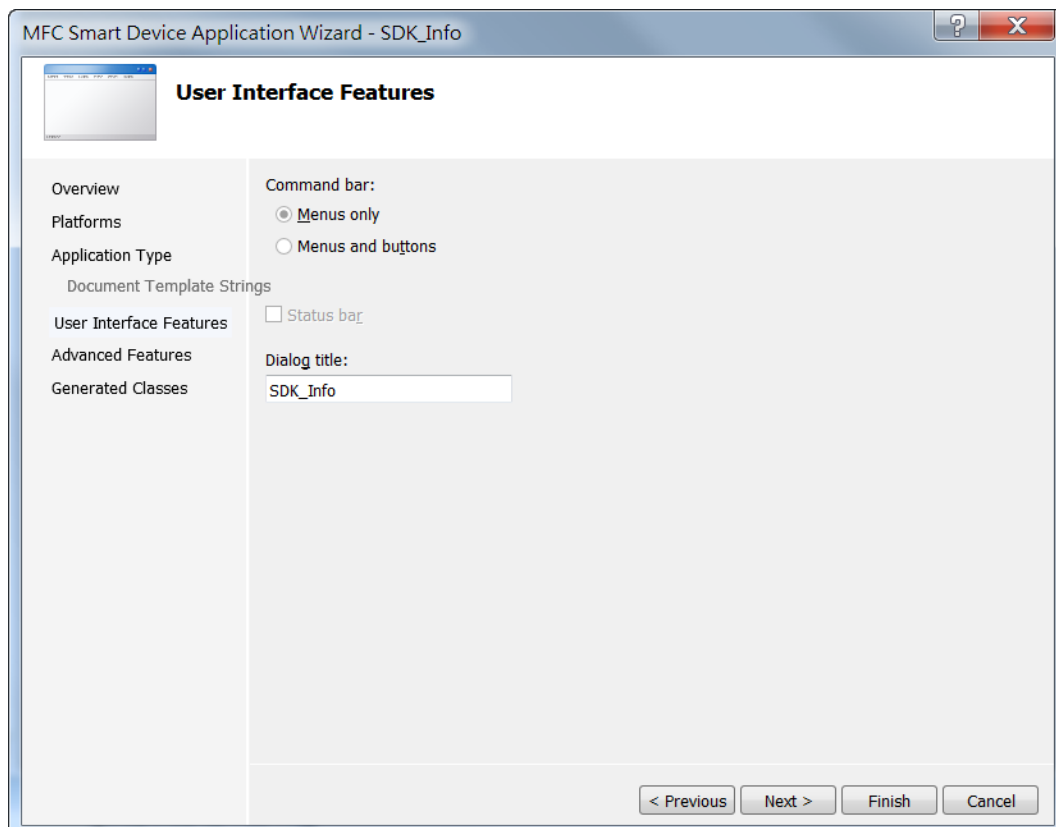

Step 10: On the next page of the wizard, click next

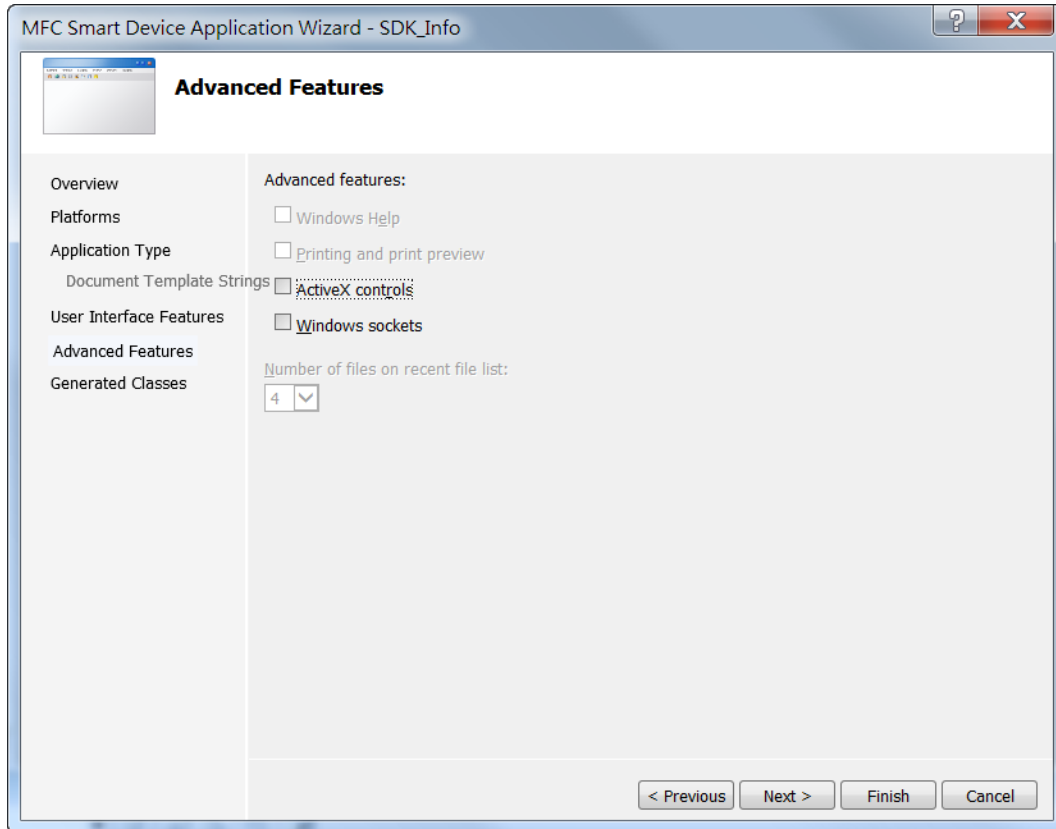

Step 11: On the next page of the wizard, click Finish

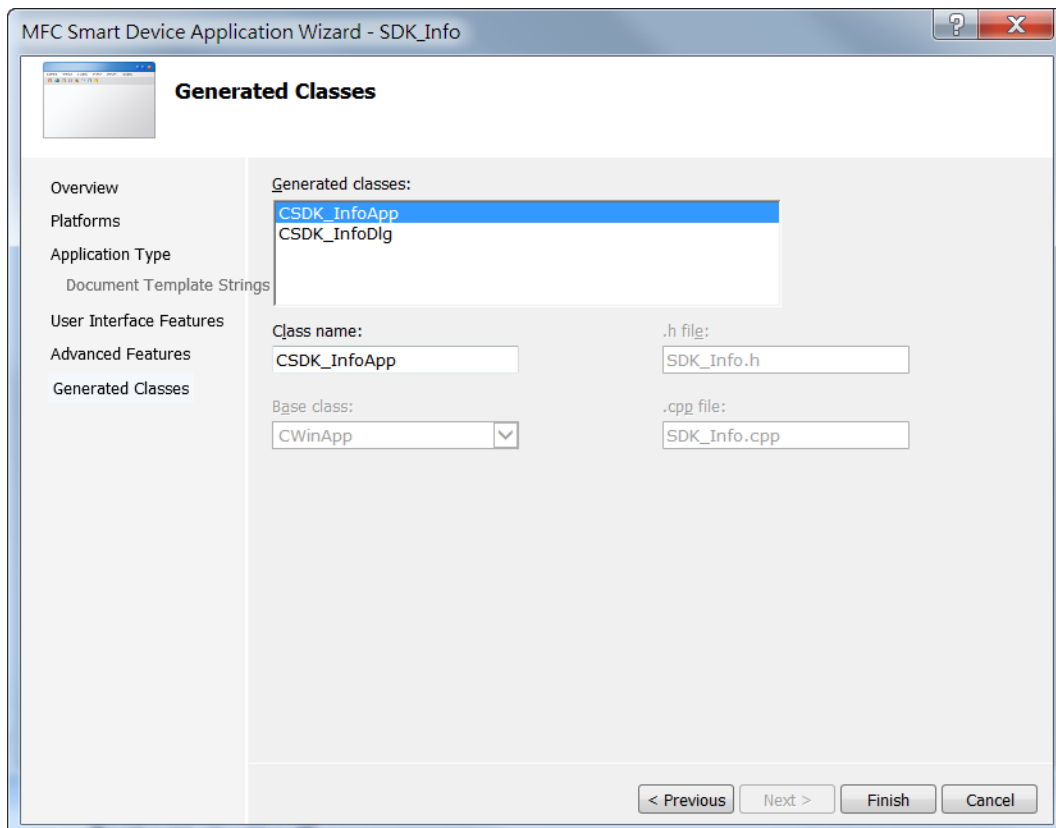

4.4.2. Configure the Platform

When developing applications by using Visual C++, you must configure the Platform to indicate what platform and device you intend to download the application to. Before you deploy your project, check the platform.

On the Debug configuration toolbar, select Release and select AM335x_WINCE7_SDK(ARMv4I) as shown in the following illustration.



4.4.3. Specify the Libraries of the PAC SDK

The PAC SDK provides the PACSDK libraries with WP-9000-CE7.

It's compatible with C++. In order to use a component in your application, you must first add a reference to it.

Step 1: On the View menu, and then click Property Pages

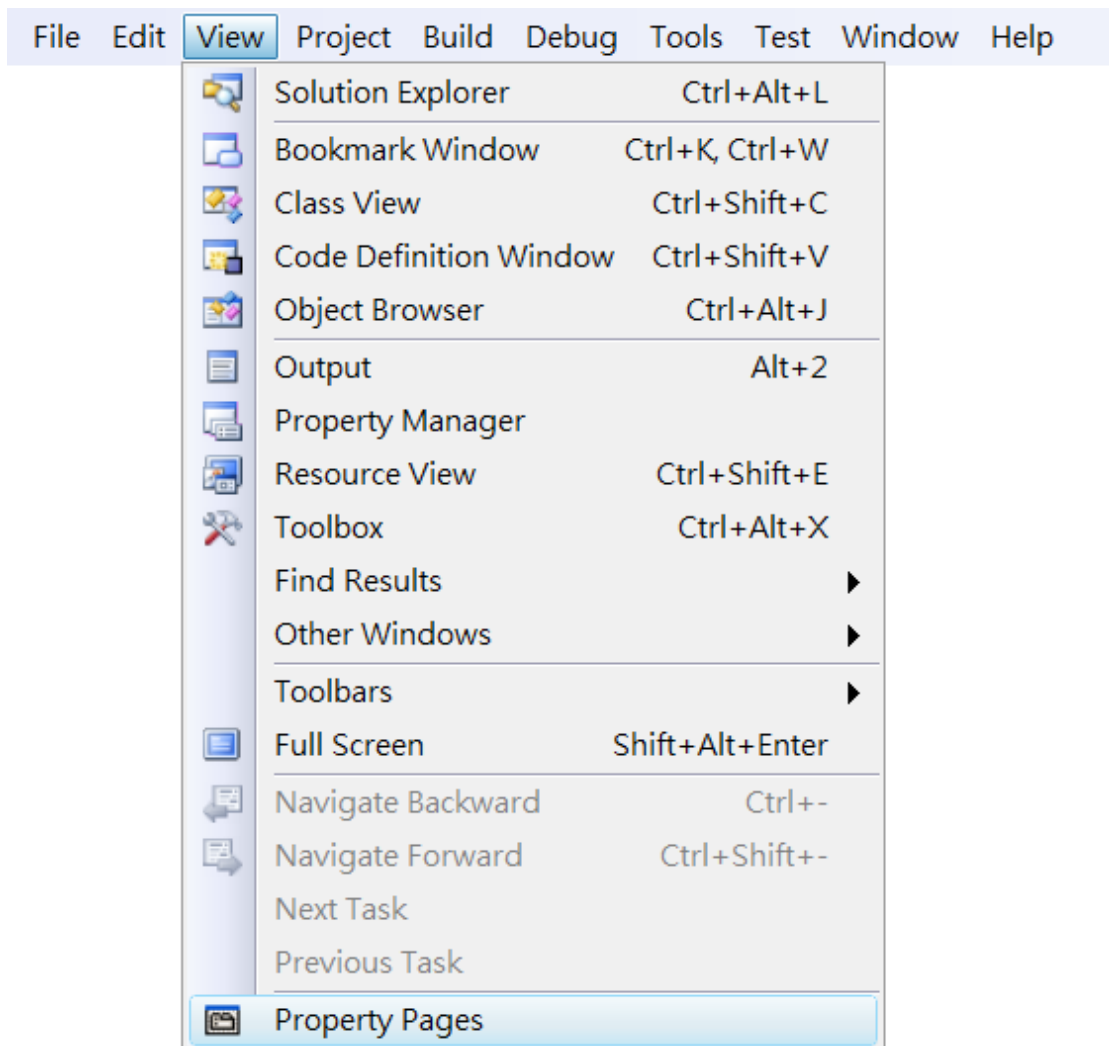

Step 2: In left pane, click Linker, and then click Input

Step 3: In the right pane, Type PACSDK.lib in the Additional Dependencies item

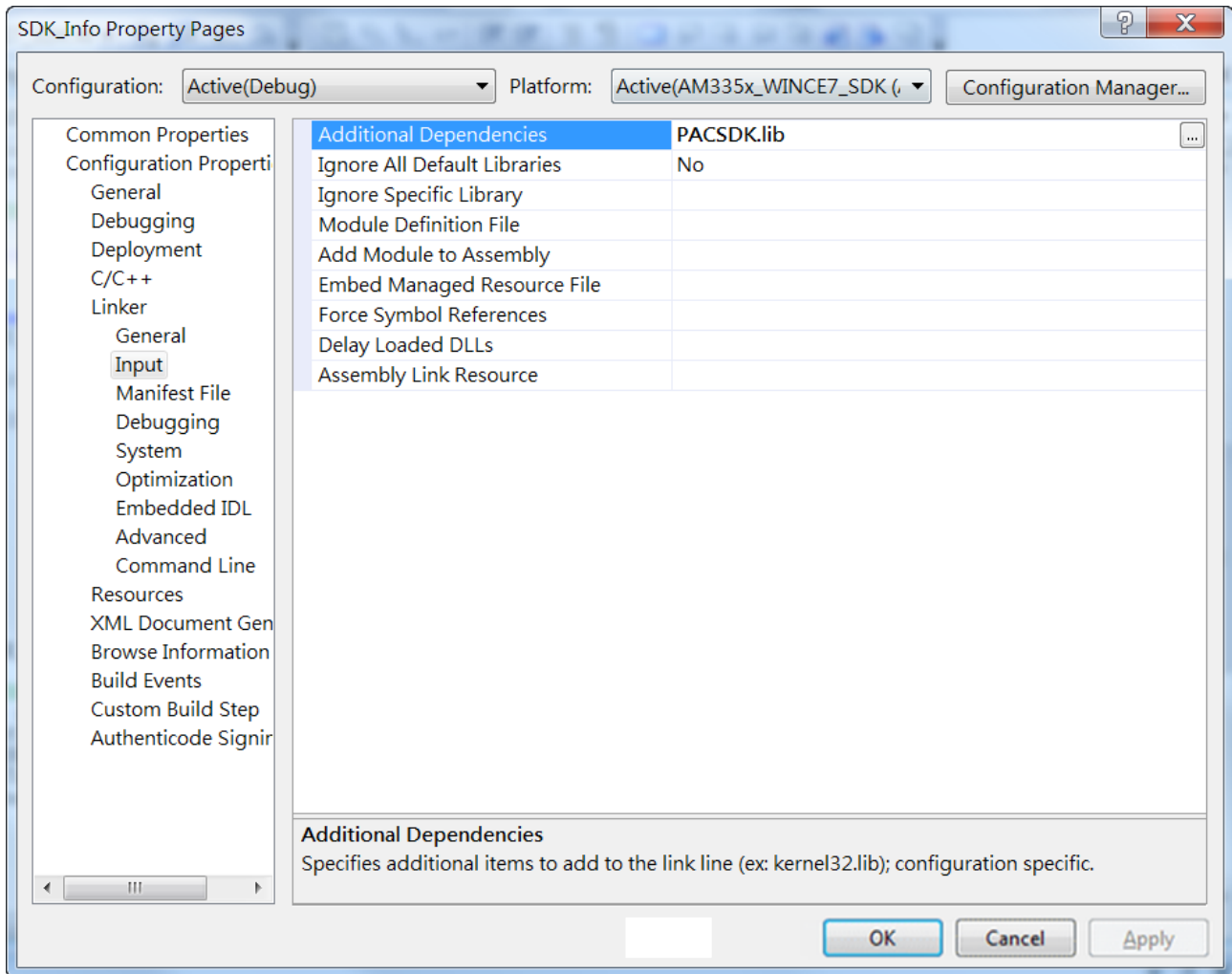

4.4.4. Add the control to the form

You can drag various controls from the Toolbox onto the form. These controls are not really "live"; they are just images that are convenient to move around on the form into a precise location.

After you add a control to your form, you can use the Properties window to set its properties, such as background color and default text. The values that you specify in the Properties window are the initial values that will be assigned to that property when the control is created at run time.

Step 1: On the View menu, and then click Resource View

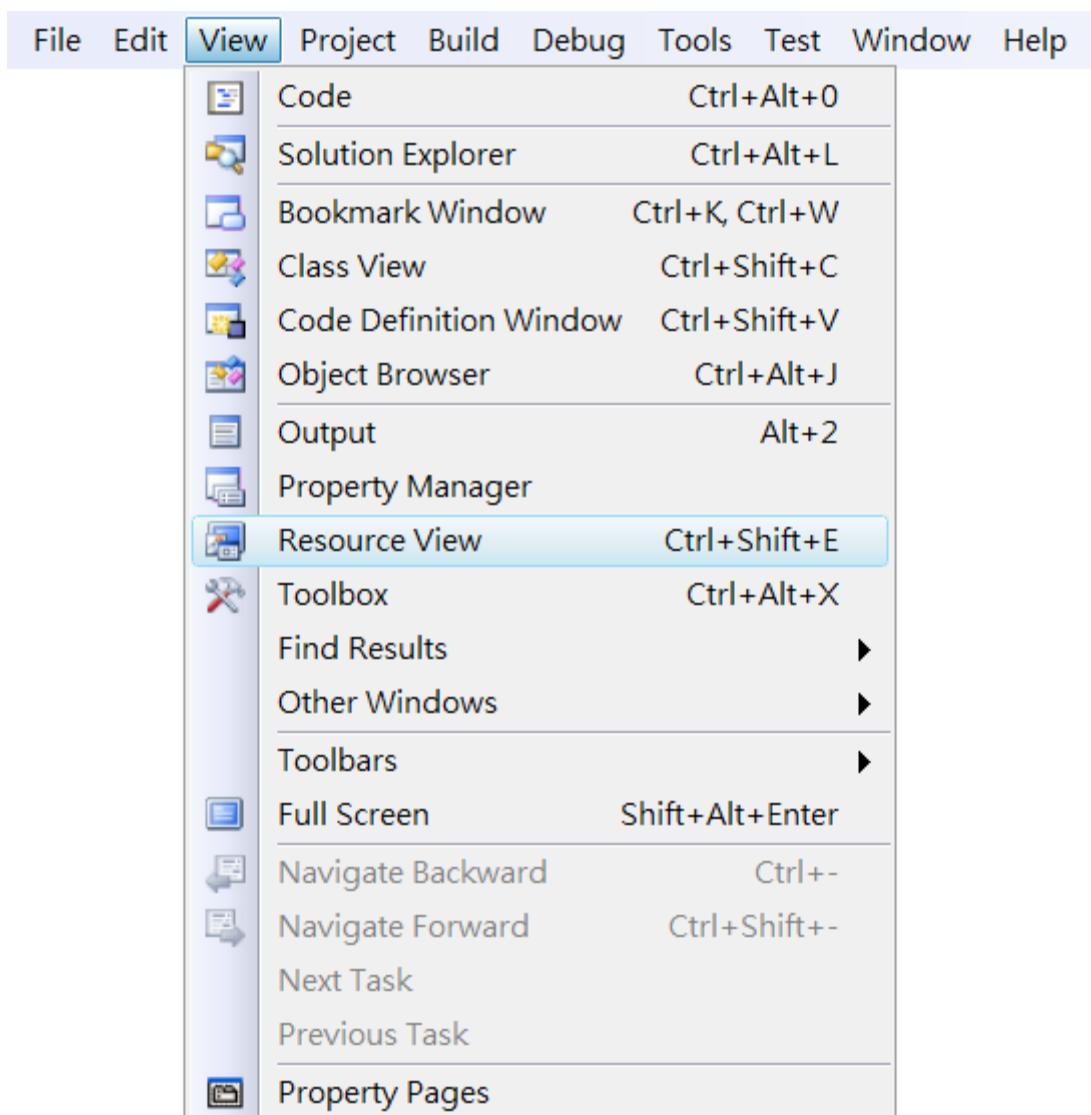

Step 2: In the Resource View Panel, Expand the [Project name].rc file and then expand the Dialog item to click the plug-in dialog

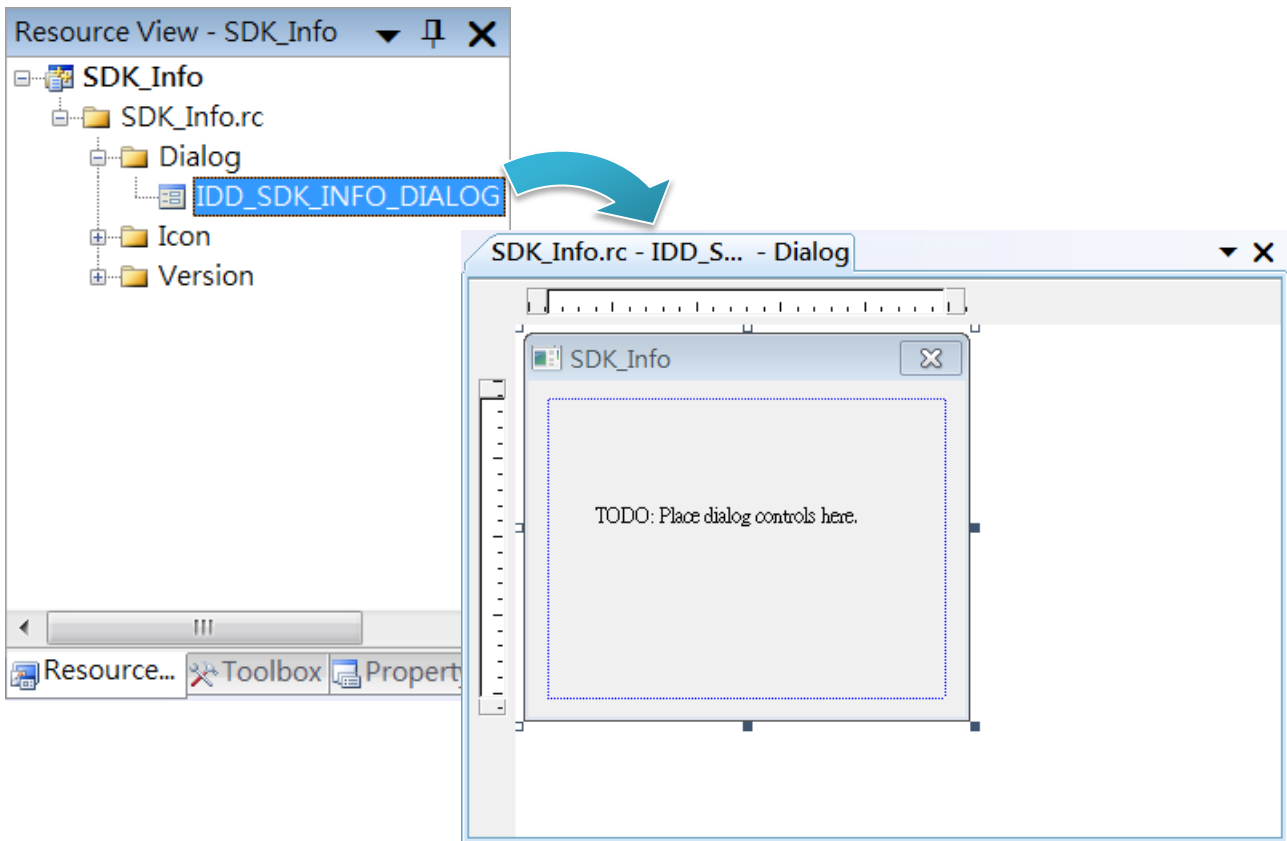

Step 3: On the Toolbox panel, drag a Button control onto the form

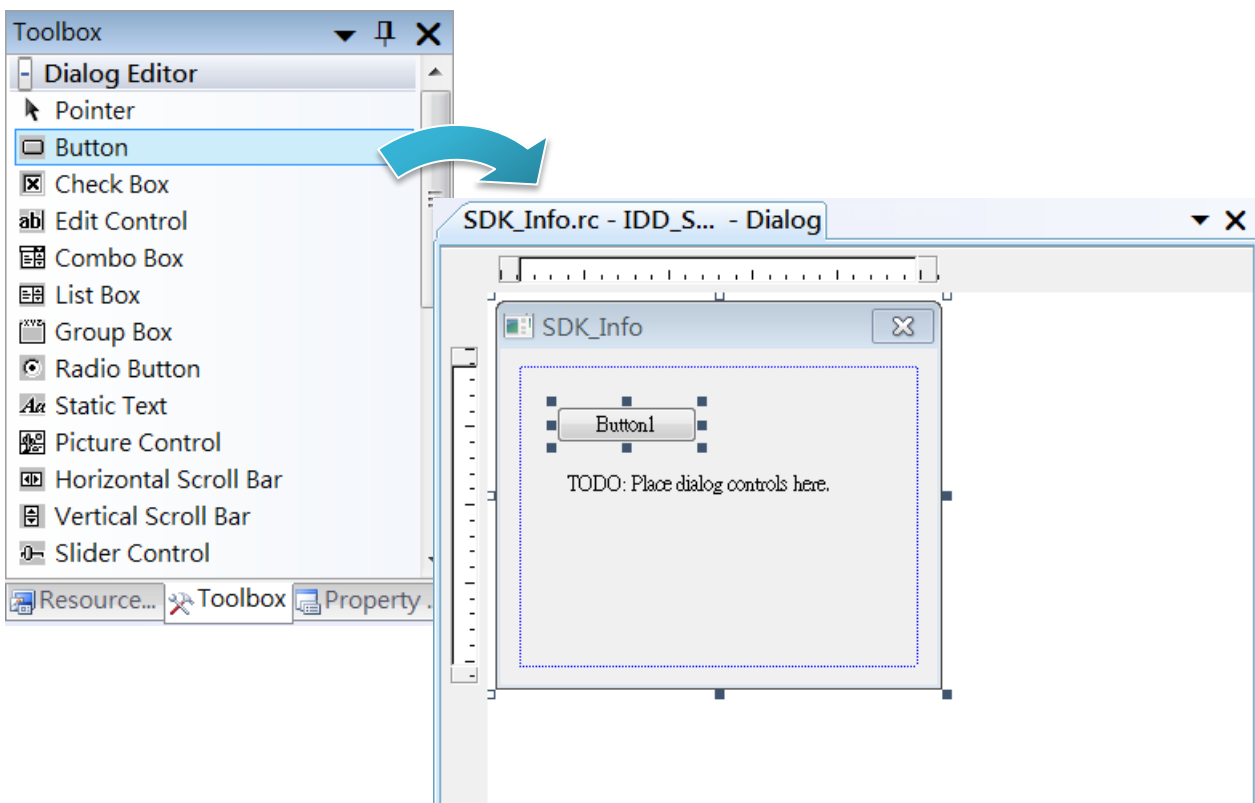

Step 4: On the Properties panel, type Check the SDK version in the Caption field

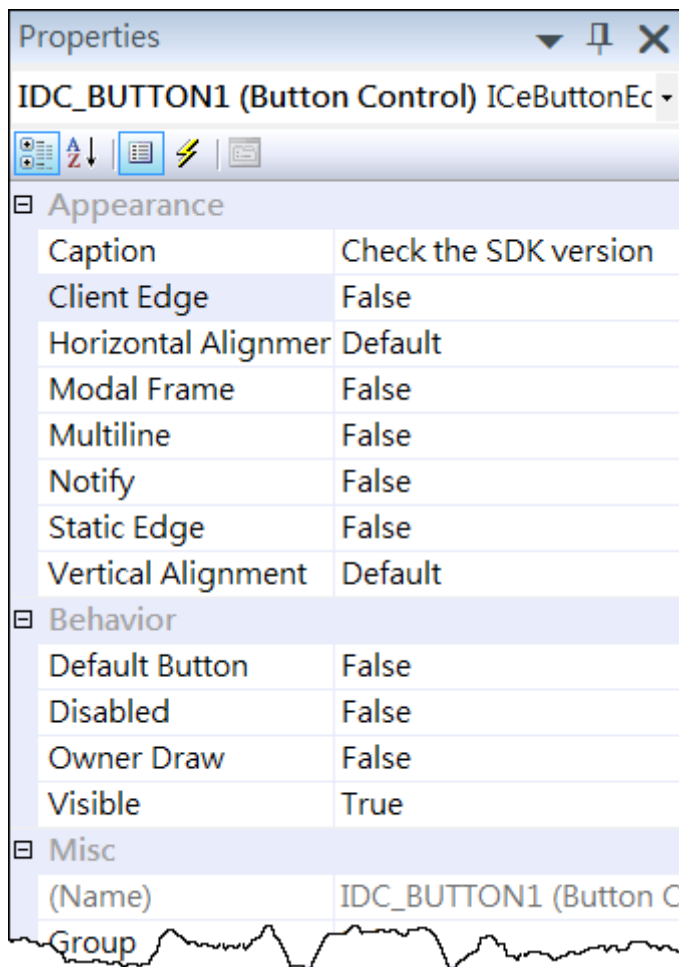

4.4.5. Add the event handling for the control

You have finished the design stage of your application and are at the point when you can start adding some code to provide the program's functionality.

Step 1: Double-click the button on the form

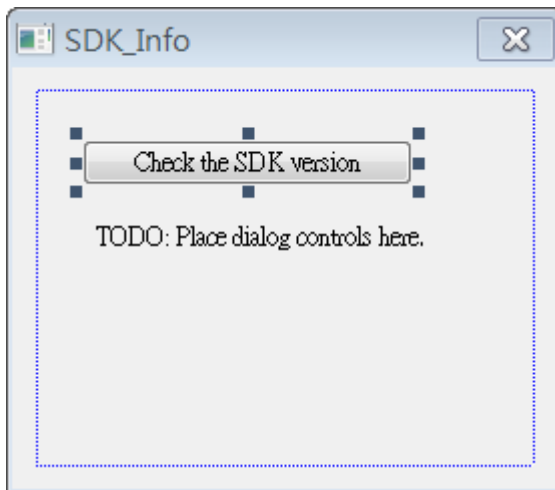

Step 2: Inserting the following code

```
char sdk_version[32];  
TCHAR buf[32];  
pac_GetSDKVersion(sdk_version);  
pac_AnsiToWideString(sdk_version, buf);  
MessageBox(buf,0,MB_OK);
```



Step 3: Inserting the following code into the header area

```
#include "PACSDK.h"
```

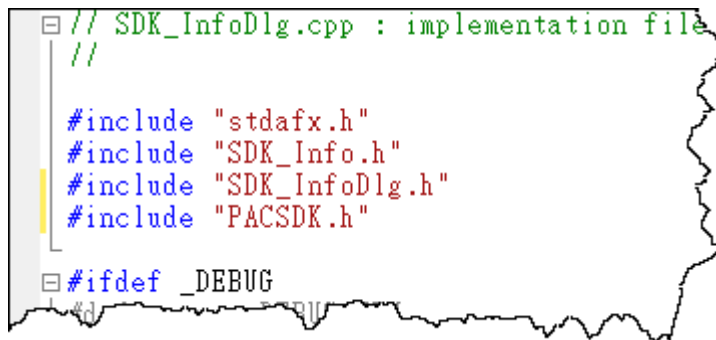

```
// SDK_InfoDlg.cpp : implementation file
//
#include "stdafx.h"
#include "SDK_Info.h"
#include "SDK_InfoDlg.h"
#include "PACSDK.h"
#ifdef _DEBUG
```

4.4.6. Upload the application to VP-X201-CE7

VP-X201-CE7 supports FTP server service. You can upload files to VP-X201-CE7 or download files from a public FTP server.

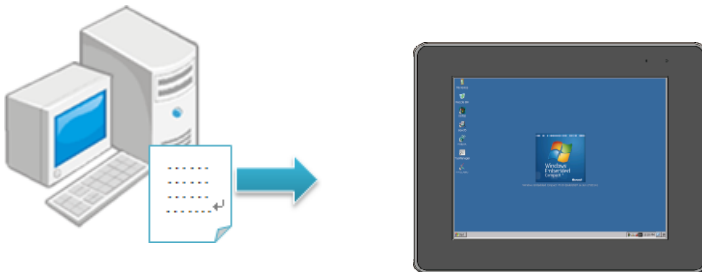

Step 1: On the Build menu, and then click Build [Project Name]

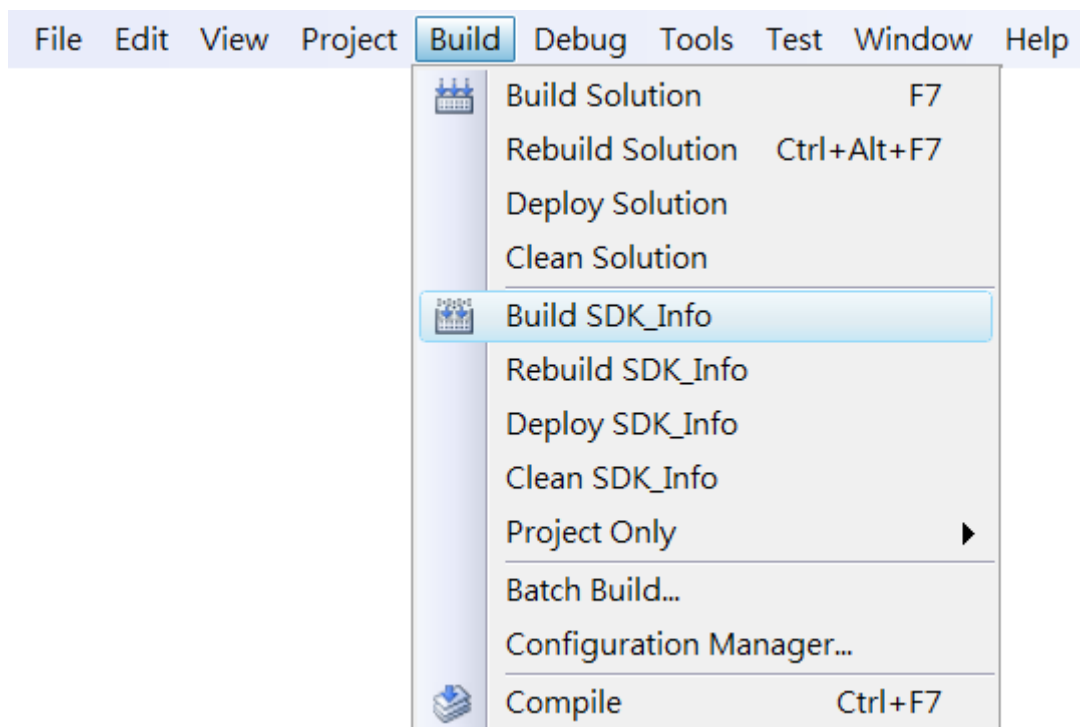

Step 2: Open the browser and type the IP address of VP-X201-CE7

Step 3: Upload the application to VP-X201-CE7

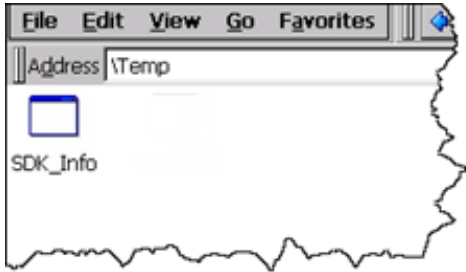

4.4.7. Execute the application on VP-X201-CE7

After uploading the application to VP-X201-CE7, you can just double-click it on VP-X201-CE7 to execute it.

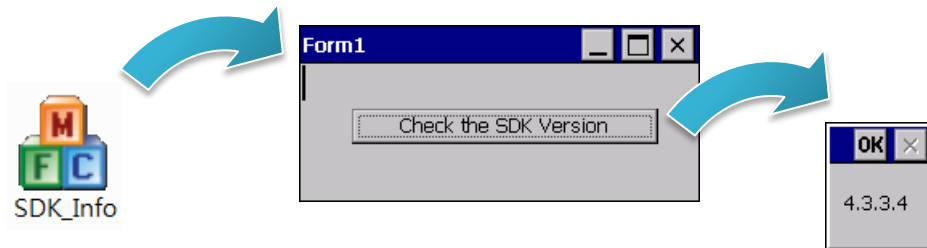

5. I/O Expansion Modules and SDKs Selection

This chapter describes how to select a suitable expansion I/O module and the corresponding SDK library to be used for developing programs on VP-X201-CE7.

VP-X201-CE7 provides the following I/O expansion buses:

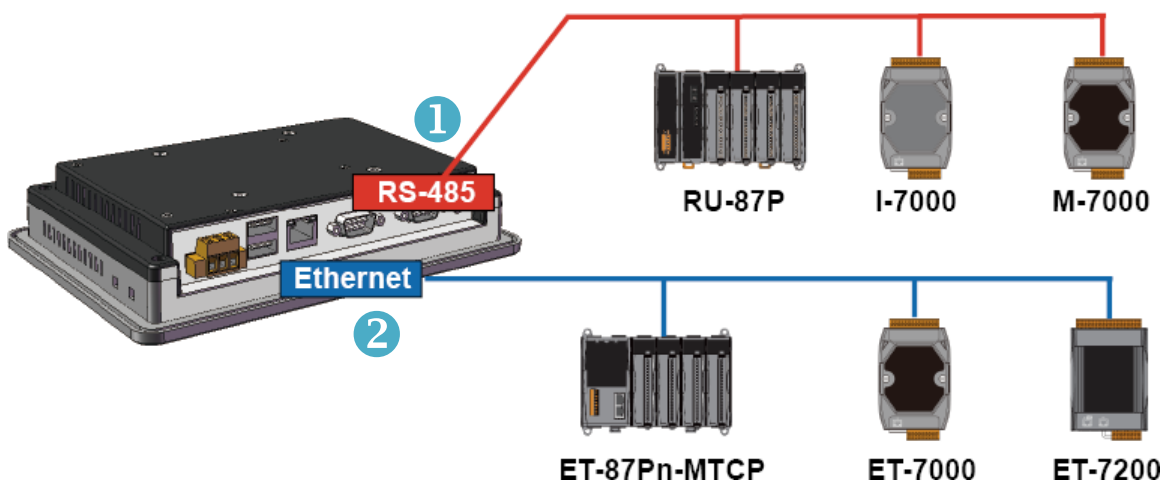

1. RS-485 (I-7000 series and M-7000 series)

I-7000, M-7000, RU-87Pn and high profile I-87K series modules connect to VP-X201-CE7 via a twisted-pair, multi-drop, 2-wire RS-485 network.

➤ I-7000 series I/O modules

Module	Native SDK	.NET CF SDK
I-7000 series	PACSDK.dll	PACNET.dll
I-7000 series with I-7088 (D)	PACSDK_PWM.dll	PACNET.dll

For full details regarding I-7000 series I/O modules and its demos, please refer to:

http://ftp.icpdas.com/pub/cd/winpac_am335x/vp-x231/pac/applicable_demo_for_7k_module.pdf

➤ M-7000 series I/O modules

Module	Native SDK	.NET CF SDK
M-7000 series	Modbus Demo	Modbus Demo

For more detailed information about M-7000 series modules using Modbus protocol and its demos, please refer to:

CD:\vp-x201\demo\nModbus\

➤ RU-87Pn + I-87K series I/O modules

Module	Native SDK	.NET CF SDK
RU-87Pn+I-87K series	PACSDK.dll	PACNET.dll

➤ Other Specified I/O

Module	Native SDK	.NET CF SDK
Others	PACSDK.dll	PACNET.dll

2. Ethernet (ET-7000 series and I-8KE4/8-MTCP)

The Ethernet I/O devices available include ET-7000 and I-8KE4/8-MTCP, and support either the DCON or the Modbus/TCP communication protocol.

Module	Native SDK	.NET CF SDK
M-7000 series	Modbus Demo	Modbus Demo
I-8KE4/8-MTCP	Modbus Demo	Modbus Demo

For more detailed information about ET-7000 and I-8KE4/8-MTCP series modules using Modbus protocol and its demos, please refer to:

http://ftp.icpdas.com/pub/cd/winpac_am335x/vp-x201/demo/nmodbus/

6. API Resources and Demo References

This chapter provides a brief overview of PAC standard APIs and demos that have been designed for VP-X201-CE7 from the PAC SDK package.

ICP DAS provides a set of demos in different programming languages. You can examine the demo codes, which includes numerous comments, to familiarize yourself with the PAC APIs. This will allow developing your own applications quickly by modifying these demo programs.

For full usage information regarding the description, prototype and the arguments of the functions, please refer to the “PAC Standard API Manual”

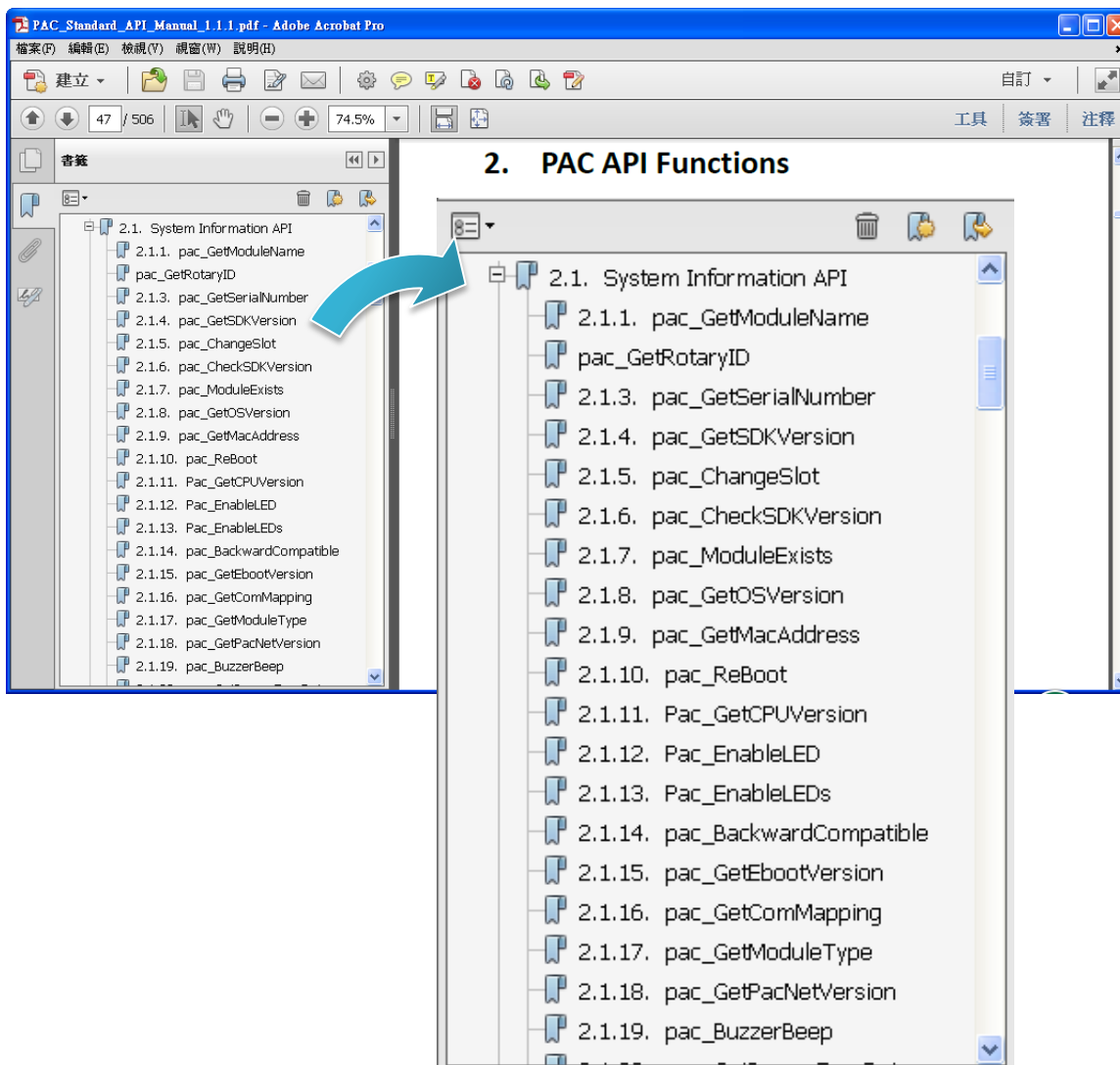

6.1. PAC Standard APIs for System Operation

The diagram below shows the set of each system operation API provided in the PACSDK.

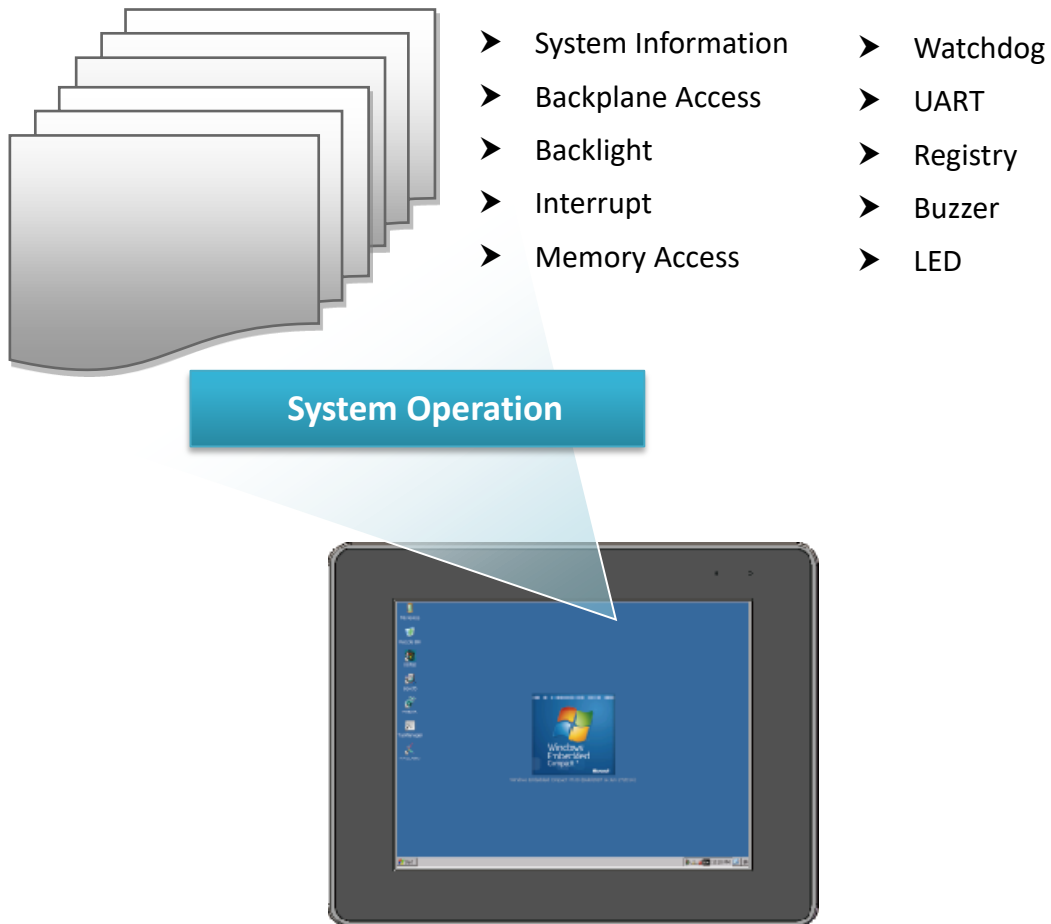

6.1.1. VB.NET Demos for PAC Standard APIs

The PAC SDK includes the following demos that demonstrate the use of the PAC Standard APIs in a VB.NET language environment.

The following demos can be found on the CD that was provided with the package or by downloading the latest version from ICP DAS web site.

CD:\vp-x201\Demo\PAC\Vb.net\Standard\

http://ftp.icpdas.com/pub/cd/winpac_am335x/vp-x201/demo/pac/vb.net/standard/

Folder	Demo	Explanation
system	systeminfo	Retrieves information about the OS version, CPU version, SDK version, etc.
backplane	backplaneinfo	Retrieves information about the DIP switch, backplane ID and slot count.
memoryaccess	memory	Shows how to read/write date values from/to EEPROM
	battery_backup_sram	Shows how to read or write to the battery backup
watchdog	watchdog	Displays how the watchdog operate
microsd	microsd_management	Shows how to enables/disables Micro SD
registry	registry	Shows how to read/write date values from/to registry
UART	diag	Shows how to read the name of local I/O modules via UART

6.1.2. C# Demos for PAC Standard APIs

The PAC SDK includes the following demos that demonstrate the use of the PAC Standard APIs in a C# language environment.

The following demos can be found on the CD that was provided with the package or by downloading the latest version from ICP DAS web site.

CD:\vp-x231\Demo\PAC\C#\Standard\

http://ftp.icpdas.com/pub/cd/winpac_am335x/vp-x201/demo/pac/c%23/standard/

Folder	Demo	Explanation
buzzer	buzzer	Shows how to make a simple buzzer beep.
DeviceInformation	DeviceInformation	Retrieves information about the OS version, CPU version, SDK version, etc.
GetRotaryID	GetRotaryID	Retrieves information about the status of the rotary switch
Memory	Memory	Shows how to read/write data values from/to the EEPROM or the backplane of the SRAM
MultiRT	MultiRT	Shows how to count real time
RealTimeTest	RealTimeTest	Writes the managed cod for the rich graphical user interface that does not require true real-time performance
Registry	Registry	Shows how to read/write data values from/to the registry
UART	UART	Shows how to read the name of a local I/O modules via a UART
WatchDog	WatchDog	Displays information about how to operate the watchdog

6.1.3. Visual C++ Demos for PAC Standard APIs

The PAC SDK includes the following demos that demonstrate the use of the PAC Standard APIs in a Visual C++ language environment.

The following demos can be found on the CD that was provided with the package or by downloading the latest version from ICP DAS web site.

CD:\vp-x231\Demo\PAC\Vc2008\Standard\

http://ftp.icpdas.com/pub/cd/winpac_am335x/vp-x201/demo/pac/vc2008/standard/

Folder	Demo	Explanation
buzzer	buzzer	Shows how to make a simple buzzer beep.
DeviceInformation	DeviceInformation	Retrieves information about the OS version, CPU version, SDK version, etc.
GetRotaryID	GetRotaryID	Retrieves information about the status of the rotary switch
Memory	Memory	Shows how to read/write data values from/to the EEPROM or the backplane of the SRAM
MultiRT	MultiRT	Shows how to count real time
RealTimeTest	RealTimeTest	Writes the managed cod for the rich graphical user interface that does not require true real-time performance
Registry	Registry	Shows how to read/write data values from/to the registry
UART	UART	Shows how to read the name of a local I/O modules via a UART
WatchDog	WatchDog	Displays information about how to operate the watchdog

6.2. PAC Standard APIs for I/O Expansion

The diagram below shows the types of the PAC IO APIs provided in the PACSDK.

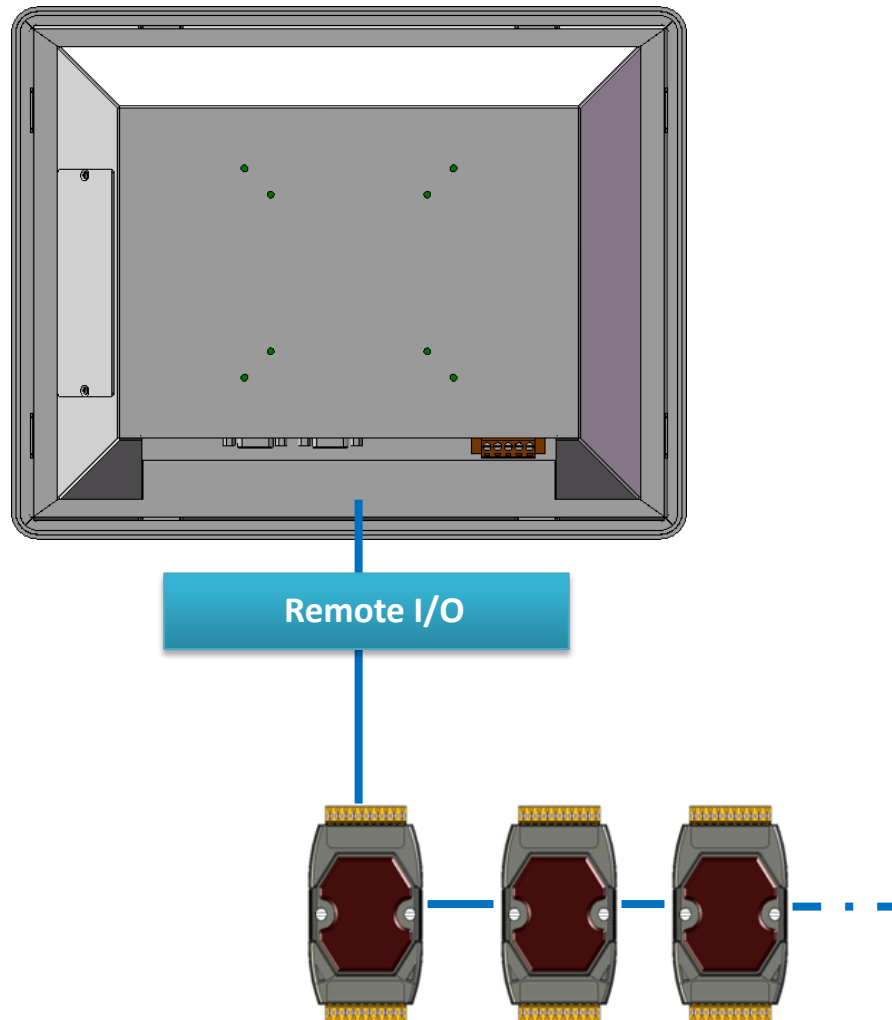

6.2.1. VB.NET Samples for PAC Standard APIs

The PAC SDK includes the following samples that demonstrate the use of the PAC IO APIs in a VB.NET language environment. The following samples can be found on the CD that was provided with the package or by downloading the latest version from ICP DAS web site.

For VB.NET applications, these demo programs can be obtained from:

CD:\vp-x201\Demo\PAC\Vb.net\IO\remote\

http://ftp.icpdas.com/pub/cd/winpac_am335x/vp-x201/demo/pac/vb.net/io/remote/

Demo	Explanation
7k87k_basic	Shows how to send/receive a command/response application. This demo program is used by 7K or 87K series AI modules which connected through a COM port.
7k87k_ai	Shows how to read the AI values of AI module. This demo program is used by 7K or 87K series AI modules which connected through a COM port.
7k87k_ao	Shows how to write the AO values to AO module. This demo program is used by 7K or 87K series AI modules which connected through a COM port.
7k87k_di	Shows how to read the DI values of DI module. This demo program is used by 7K or 87K series AI modules which connected through a COM port.
7k87k_do	Shows how to write the DO values to DO module. This demo program is used by 7K or 87K series AI modules which connected through a COM port.
7k87k_dio	Shows how to read the DI and the DO values of the DIO module. This demo program is used by 7K or 87K series AI modules which connected through a COM port.

6.2.2. C# Samples for PAC Standard APIs

The PAC SDK includes the following samples that demonstrate the use of the PAC IO APIs in a C# language environment. The following samples can be found on the CD that was provided with the package or by downloading the latest version from ICP DAS web site.

For C# applications, these demo programs can be obtained from:

CD:\vp-x201\Demo\PAC\C#\IO\remote\

http://ftp.icpdas.com/pub/cd/winpac_am335x/vp-x201/demo/pac/c%23/io/remote/

Demo	Explanation
7k87k_basic	Shows how to send/receive a command/response application. This demo program is used by 7K or 87K series AI modules which connected through a COM port.
7k87k_ai	Shows how to read the AI values of AI module. This demo program is used by 7K or 87K series AI modules which connected through a COM port.
7k87k_ao	Shows how to write the AO values to AO module. This demo program is used by 7K or 87K series AI modules which connected through a COM port.
7k87k_di	Shows how to read the DI values of DI module. This demo program is used by 7K or 87K series AI modules which connected through a COM port.
7k87k_do	Shows how to write the DO values to DO module. This demo program is used by 7K or 87K series AI modules which connected through a COM port.
7k87k_dio	Shows how to read the DI and the DO values of the DIO module. This demo program is used by 7K or 87K series AI modules which connected through a COM port.

6.2.3. Visual C++ Samples for PAC Standard APIs

The PAC SDK includes the following samples that demonstrate the use of the PAC IO APIs in a Visual C++ language environment. The following samples can be found on the CD that was provided with the package or by downloading the latest version from ICP DAS web site.

For Visual C++ applications, these demo programs can be obtained from:

CD:\vp-x201\Demo\PAC\Vc2008\IO\remote\

http://ftp.icpdas.com/pub/cd/winpac_am335x/vp-x201/demo/pac/vc2008/io/remote/

Demo	Explanation
7k87k_basic	Shows how to send/receive a command/response application. This demo program is used by 7K or 87K series AI modules which connected through a COM port.
7k87k_ai	Shows how to read the AI values of AI module. This demo program is used by 7K or 87K series AI modules which connected through a COM port.
7k87k_ao	Shows how to write the AO values to AO module. This demo program is used by 7K or 87K series AI modules which connected through a COM port.
7k87k_di	Shows how to read the DI values of DI module. This demo program is used by 7K or 87K series AI modules which connected through a COM port.
7k87k_do	Shows how to write the DO values to DO module. This demo program is used by 7K or 87K series AI modules which connected through a COM port.
7k87k_dio	Shows how to read the DI and the DO values of the DIO module. This demo program is used by 7K or 87K series AI modules which connected through a COM port.

7. VP-X201-CE7 Updates

This chapter provides a guided tour that demonstrates the steps needed to update the VP-X201-CE7 OS and SDKs.

ICP DAS will continue to add additional features to VP-X201-CE7 SDK and OS in the future, so we advise you to periodically check the ICP DAS web site for the latest updates.

The file location of the OS and SDK

Both the files of OS updates and SDK updates can be found on the CD that was provided with the package or by downloading the latest version from ICP DAS web site.

CD:\vp-x201\
http://ftp.icpdas.com/pub/cd/winpac_am335x/vp-x201/

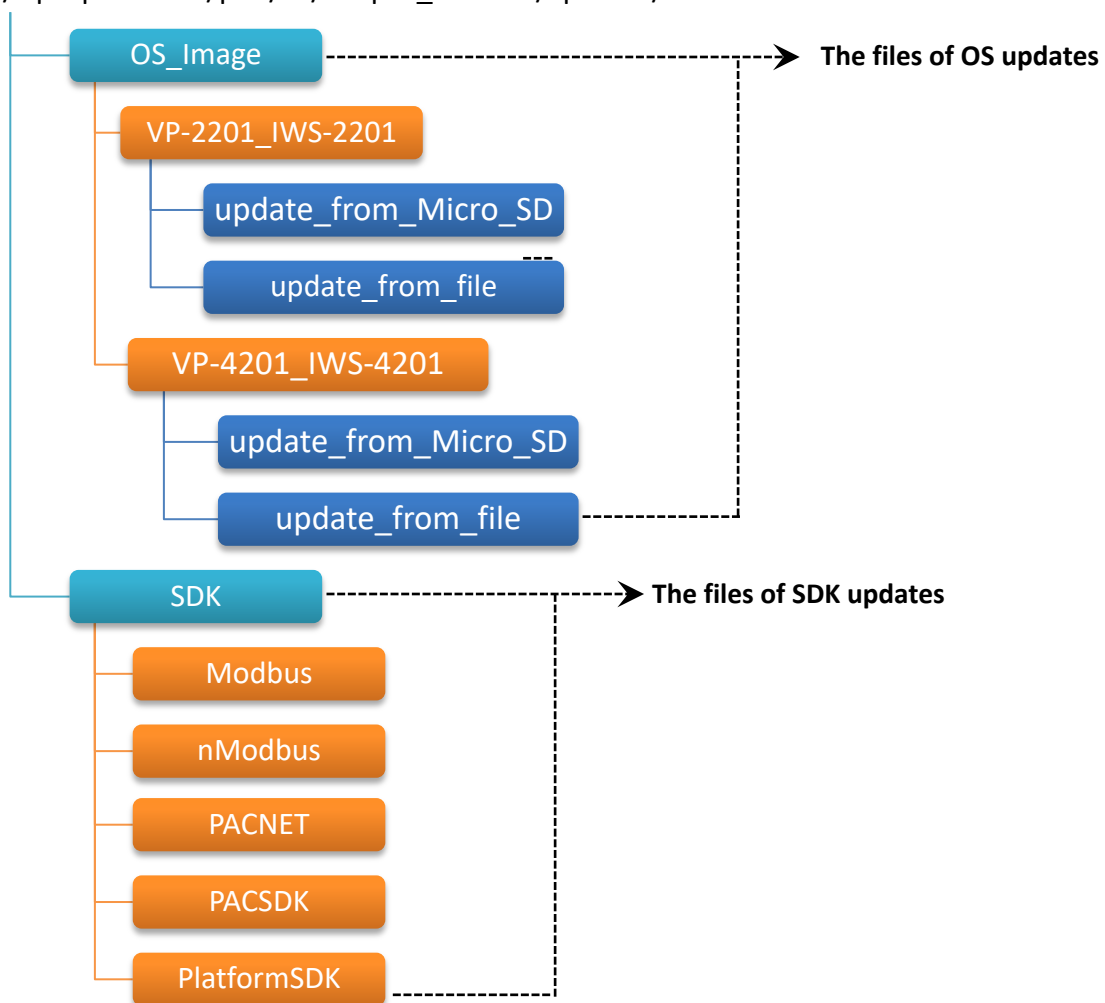

7.1. OS Updates

The latest version of the VP-X201-CE7 OS image can be found separately on the CD that was provided with the package or by downloading the latest version from ICP DAS web site.

CD:\vp-x201\
http://ftp.icpdas.com/pub/cd/winpac_am335x/vp-x201/

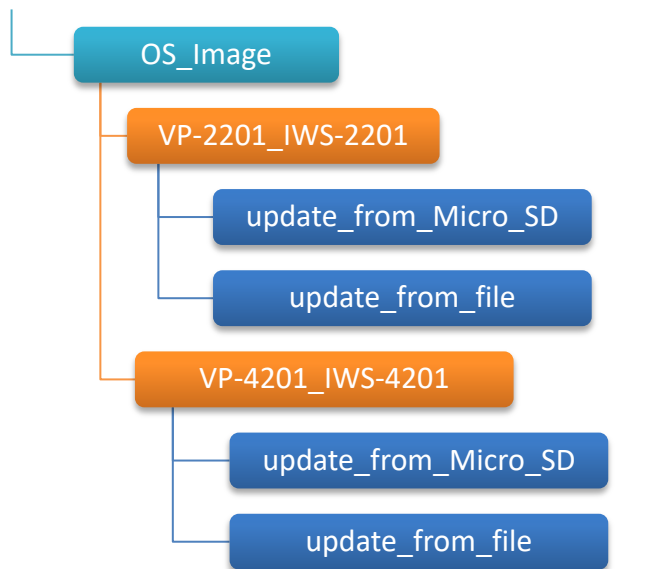

There are two ways to update the OS:

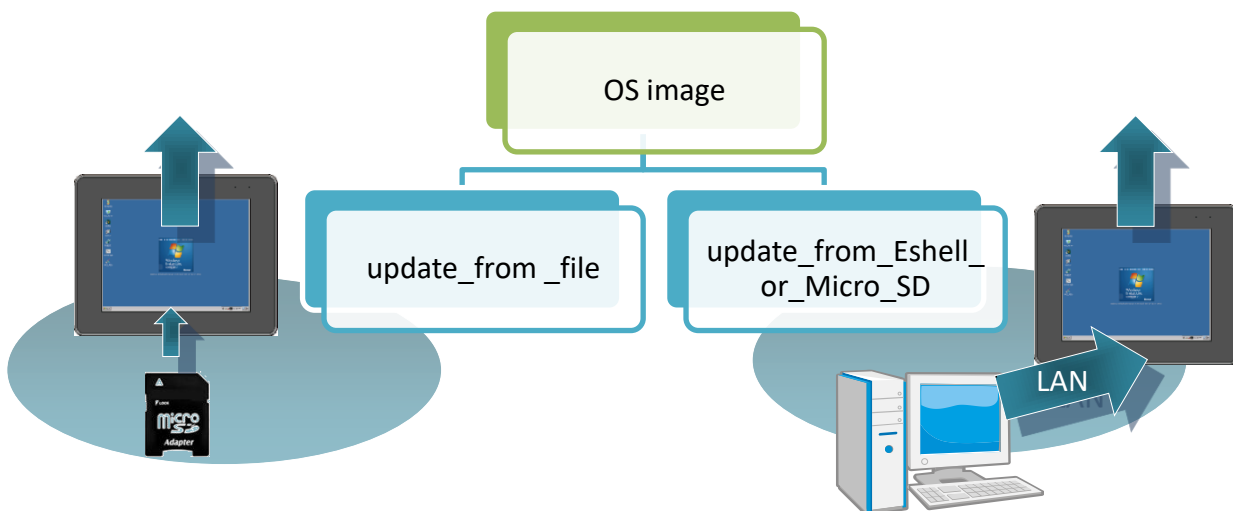

1. OS updates from eshell (Please refer to section 7.1.1)
(We recommend that you use this one for more quicker and easier to update)
2. OS updates from micro_SD (Please refer to section 7.1.2)

7.1.1. OS Updates from Eshell

By default, the OS update is updated via a LAN.
Before updating the OS, make sure the LAN is connected to PC.

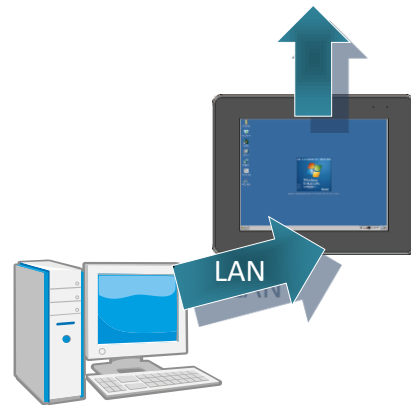

Step 1: Get the latest version of the installation package file and then unzip it

The latest version of the installation package file can be found from ICP DAS web site.

For VP-2201-CE7:

http://ftp.icpdas.com/pub/cd/winpac_am335x/vp-x201/os_image/VP-2201_IWS-2201/update_from_eshell_or_micro_sd

For VP-3201-CE7/VP-4201-CE7/VP-5201-CE7/VP-6201-CE7:

http://ftp.icpdas.com/pub/cd/winpac_am335x/vp-x201/os_image/VP-4201_IWS-4201/update_from_eshell_or_micro_sd

Step 2: Run the registry clear.exe

The registry.exe can be found on the CD that was provided with the package or by downloading the latest version from ICP DAS web site.

CD:\vp-x201\PC_Tools\Eshell

http://ftp.icpdas.com/pub/cd/winpac_am335x/vp-x201/pc_tools/eshell/

Step 3: Place the rotary switch in position 3, OS update mode



Step 4: Run the ESHELL.exe, and then restart the VP-X201-CE7-CE7

The ESHELL.exe can be found on the CD that was provided with the package or by downloading the latest version from ICP DAS web site.



CD:\vp-x201\PC_Tools\Eshell

http://ftp.icpdas.com/pub/cd/winpac_am335x/vp-x201/pc_tools/eshell/

Step 5: Select the device which you want to update the OS image, and then click OK

Select the device name which you want to update the OS image from the list.

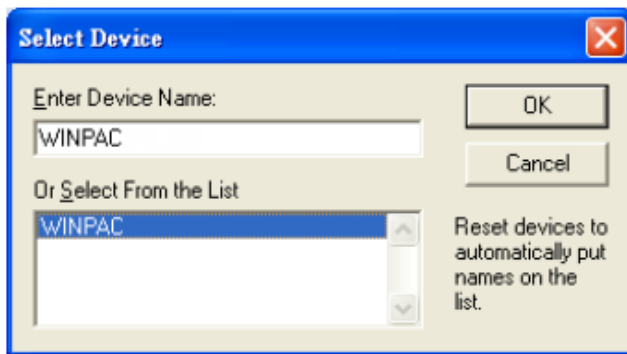

Step 6: Select the latest version of the OS image file

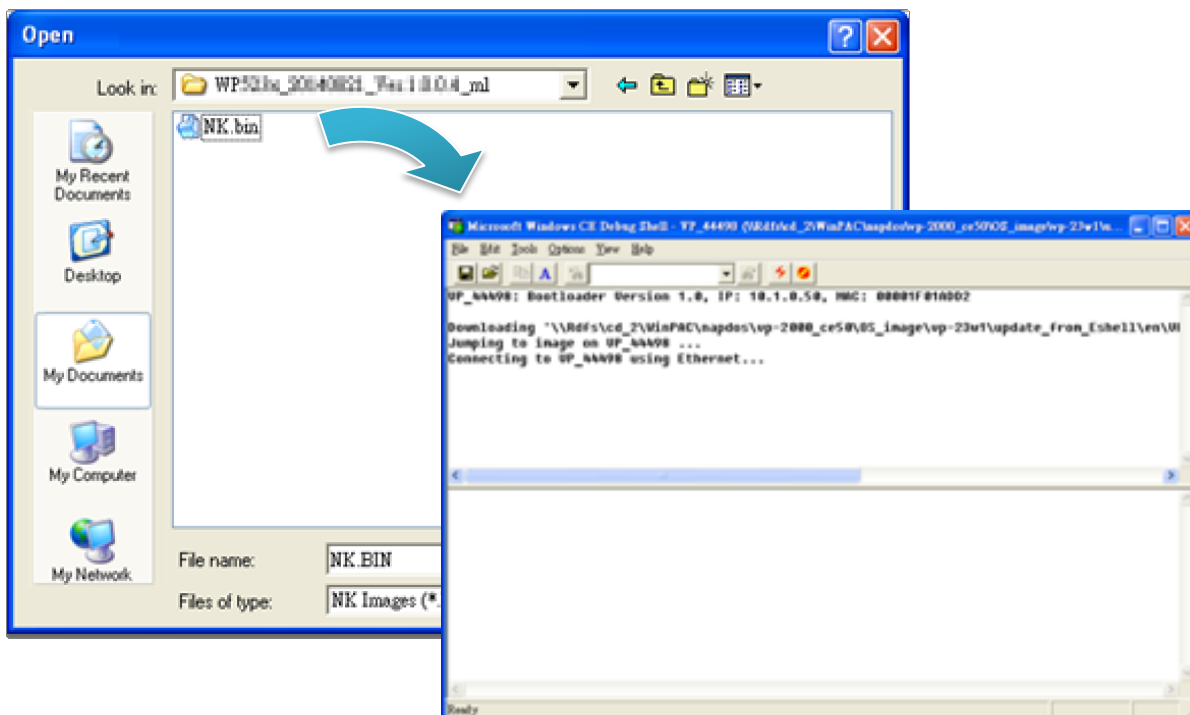

Step 7: Once the procedure is completed, the “Warning !” dialog box will appear as below shown, then turn the rotary switch in position 0, normal mode

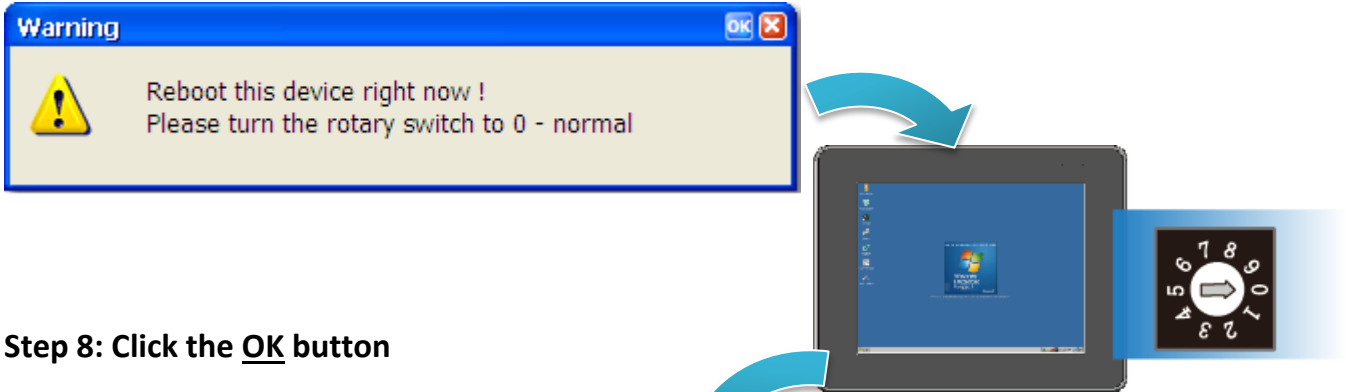

Step 8: Click the OK button

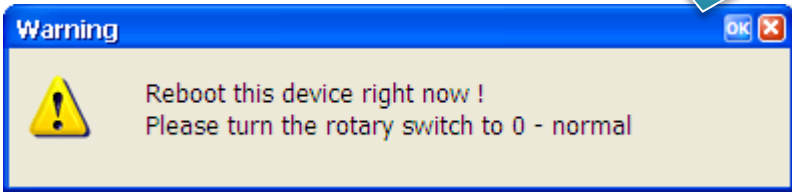

Step 9: Check the OS version

Run the PAC Utility, and then select the Device Information tab to check the current OS version.

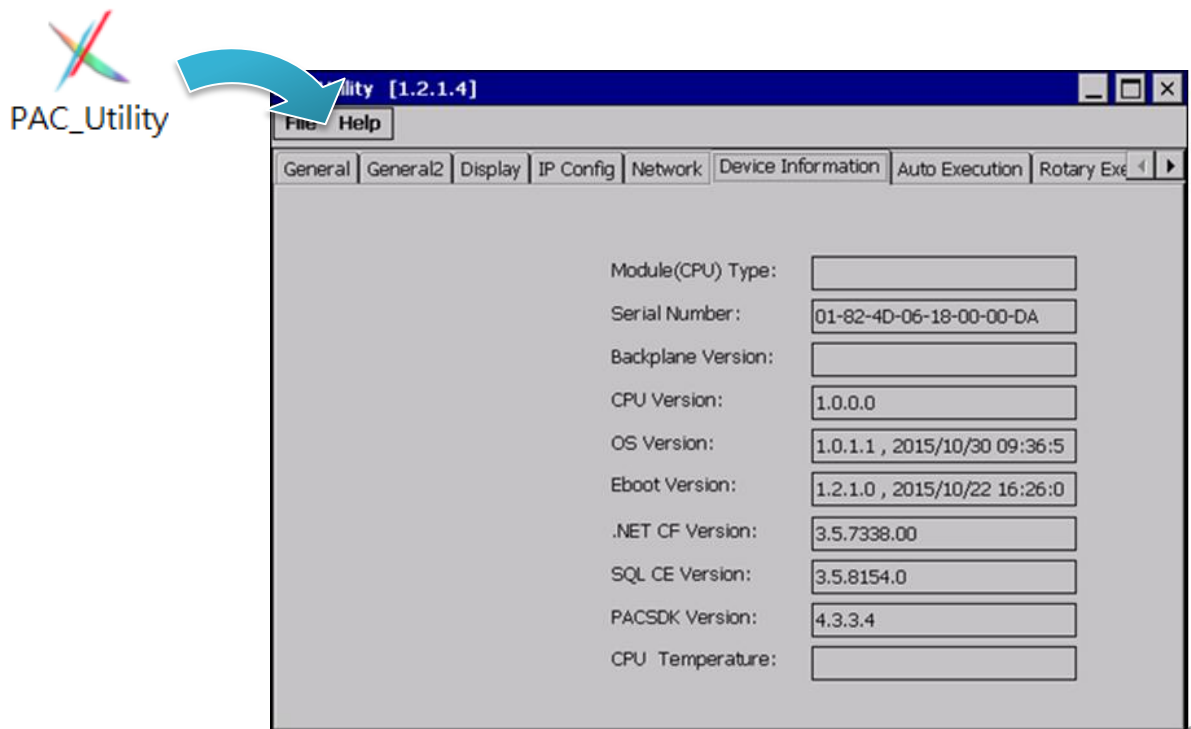

7.1.2. OS updates using micro_SD

The microSD card can be used to reinstall the VP-X201-CE7 OS image to factory default settings in the event of the VP-X201-CE7 failure.

Step 1: Get the latest version of the installation package file, then unzip the file, and then copy them to microSD card

The latest version of the installation package file can be found from ICP DAS web site.

http://ftp.icpdas.com/pub/cd/winpac_am335x/vp-x201/os_image/VP-2201_IWS-2201/update_from_eshell_or_micro_sd/



Step 2: Plug the microSD card into microSD slot

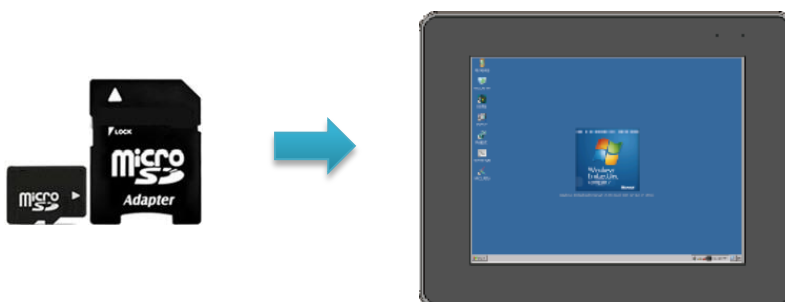

Step 3: Turn the rotary switch in position 5, OS update mode

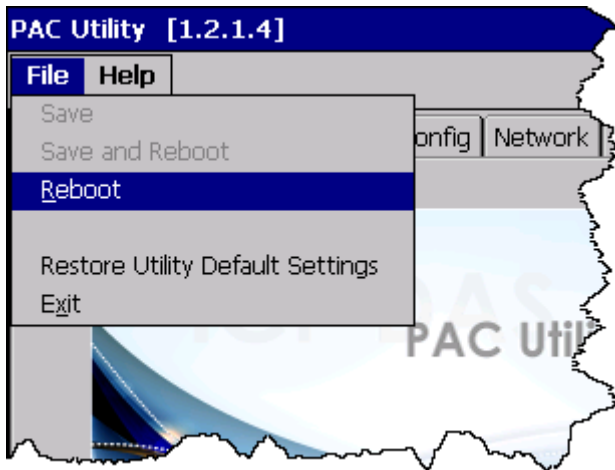

Step 4: Reboot the VP-X201-CE7

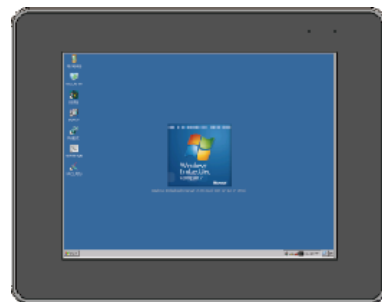

Step 5: Wait a few minutes for the desktop to be displayed

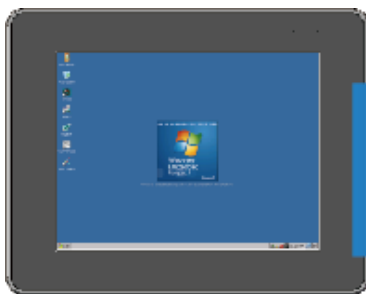

Step 6: Turn the rotary switch in position 0, normal mode

Step 7: Reboot the VP-X201-CE7

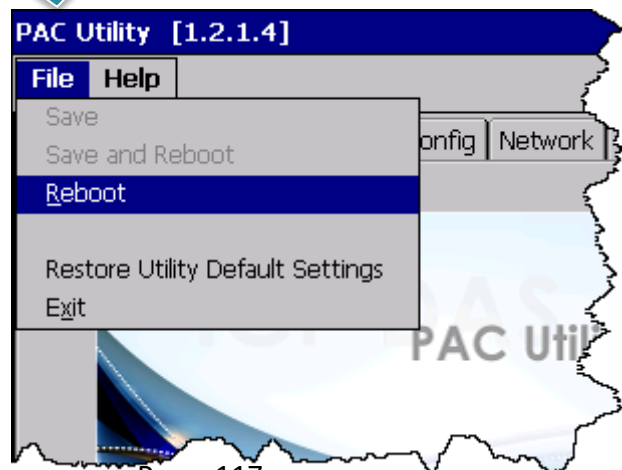

Step 8: Check the OS version

Run the PAC Utility, and then select the Device Information tab to check the current OS version.

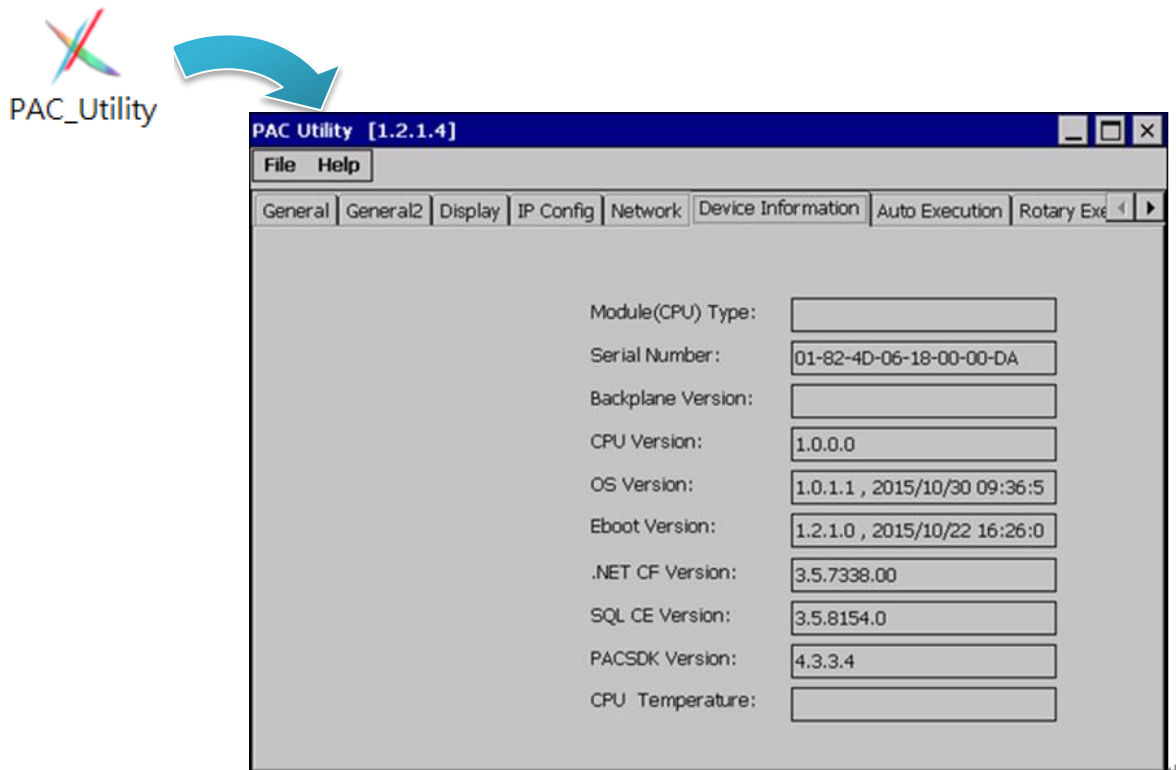

7.2. SDK Updates

SDK update is a part of the VP-X201-CE7 update services to provide additional and more efficient features and functionality for VP-X201-CE7 operating system.

The SDK update files can be found separately on the CD that was provided with the package or by downloading the latest version from ICP DAS web site.

CD:\vp-x201\SDK\

http://ftp.icpdas.com/pub/cd/winpac_am335x/vp-x201/sdk/

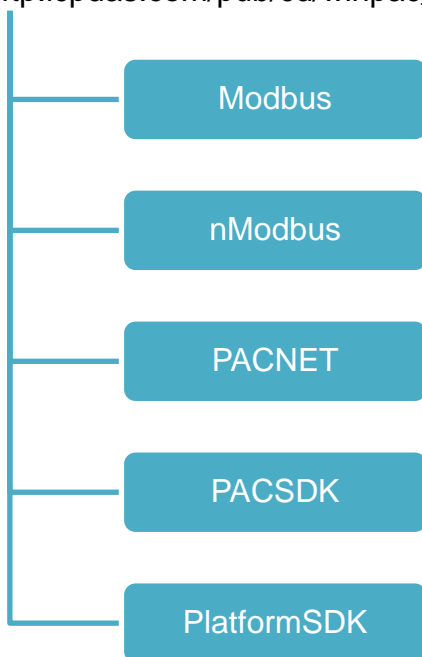

7.2.1. SDK Updates for VB.NET or C#

The SDK can be updated by changing the SDK file.

Step 1: Get the latest version of the PACNET.dll file

The latest version of the PACNET.dll file can be obtained from ICP DAS web site.

http://ftp.icpdas.com/pub/cd/winpac_am335x/vp-x201/sdk/pacnet/

Step 2: Copy the latest version of PACNet.dll file to PC and VP-X201-CE7

The PACNET.dll file on PC can be placed anywhere only the solution can reference it.

The PACNET.dll file on VP-X201-CE7 is located at the same directory as the .exe file.

7.2.2. SDK Updates for VB.NET or Visual C++

The SDK can be updated by changing the SDK file.

Step 1: Get the latest version of the VC++ components

The latest version of the VC++ components can be obtained from:

http://ftp.icpdas.com/pub/cd/winpac_am335x/vp-x201/sdk/pacsdk/

Step 2: Copy the latest version of header files and libraries to PC

The header files are located at:

C:\Program Files\Windows CE Tools\SDKs\AM335x_WINCE7_SDK\Include\Armv4i

The libraries are located at:

C:\Program Files\Windows CE Tools\SDKs\AM335x_WINCE7_SDK\Lib\ARMv4I

Step 3: Copy the latest version of DLL files to VP-X201-CE7

The DLL files are located at:

\System_Disk\ICPDAS\System

8. ViewPAC Download Center

This chapter provides a brief introduction of the ViewPAC download center.

ViewPAC has a download center where you can access the latest version of the software, tools, demo programs, and related information.

The ViewPAC Download Center can be found at:

http://www.icpdas.com/root/support/download/pac/viewpac-ce7/viewpac-ce7_download_os_images.html

ViewPAC (CE7-Based) Download Center

Note:
When you download the software programs, you should notice if the programs conform to your machine. Before you download any program, please read the notes of each online program first to avoid the confused situation.

OS images SDK Utility & Tools Demo Documents System Disk FAQ

OS images download



Note:
Before you download the software programs, you should notice if the programs are compatible to your machine. **Please read the notes first in each chapter you want before download programs.**

How to upgrade OS image for ViewPAC

There are two methods to upgrade OS image. The first one is to run installation package file on ViewPAC and the second is to use Eshell.exe to upgrade OS image through Ethernet.

Installation package is easier to upgrade OS image, you just copy the package file(.exe) to ViewPAC, double-click to run it and follow the instructions.

Eshell.exe runs on PC side (Windows OS) and downloads OS into ViewPAC through local-area network. For detail information, please refer to the document as follows:

Update OS manual		
How to update os image by Micro_SD	v 1.0.0	
How to update os image_by eshell through Ethernet	v 1.0.0	

Tips & How to

This chapter provides tips and a guided tour on using and maintaining the VP-X201-CE7.

A. How to Online Debug the VP-X201-CE7 Program

Here are step by step instructions on how to online debug the VP-X201-CE7 program.

Tips & Warnings



Before starting online debug the VP-X201-CE7 program, make sure that the VP-X201-CE7 SDK has been installed correctly.

For more information on how to install the VP-X201-CE7 SDK, please refer to 4.1.2. Installing the VP-X201-CE7 SDK.

Step 1: Copy the following files to the \System_Disk\icpdas\system on the VP-X201-CE7

By default, these files are located on the development computer at C:\Program Files\Common Files\Microsoft Shared\CoreCon\1.0\Target\wce400\<CPU>.

- clientshutdown.exe
- CMAccept.exe
- ConmanClient2.exe
- eDbgTL.dll
- TcpConnectionA.dll

Step 2: Run the ConmanClient2.exe and then CMAccept.exe on the VP-X201-CE7

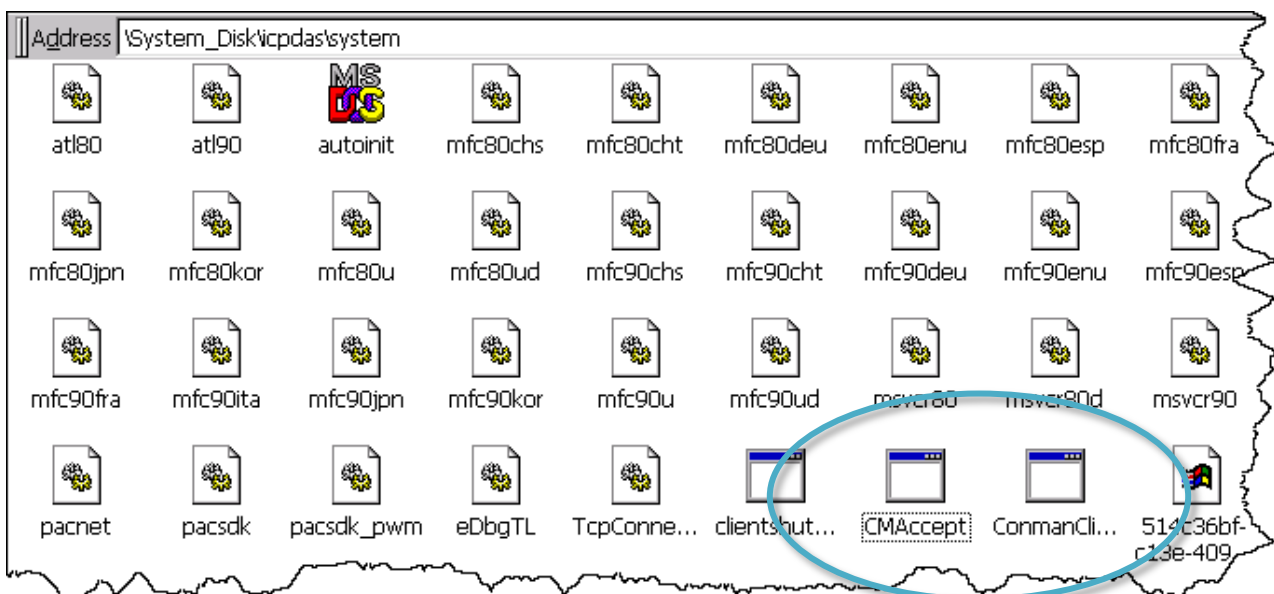

Step 3: On the Tools menu, click the Options

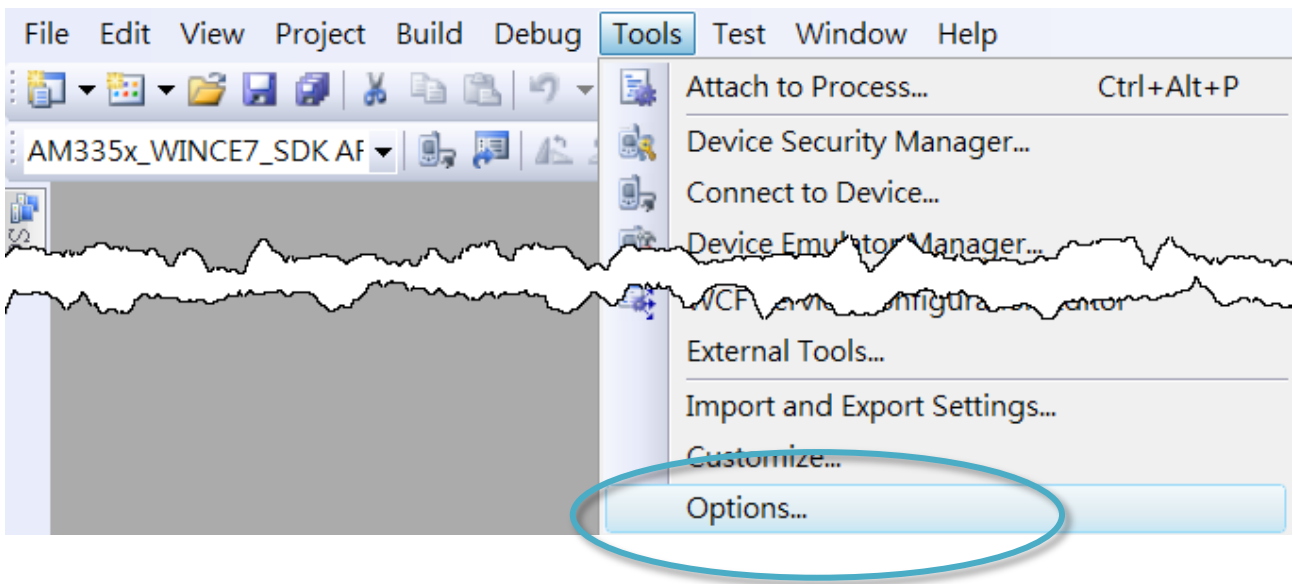

Step 4: In the left pane, expand Device Tools node and select Devices

Step 5: In the Show devices for platform:, select AM335x WINCE7 SDK and then click Properties

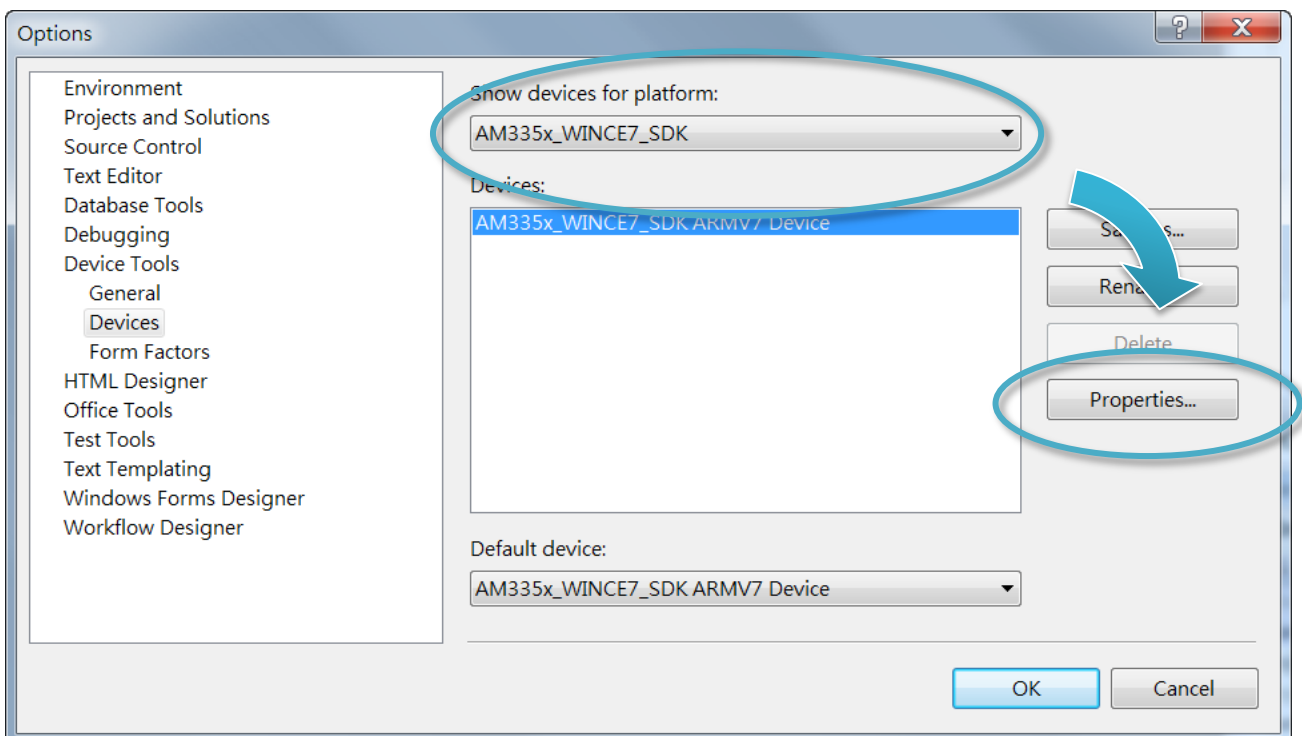

Step 6: Click the Configure...

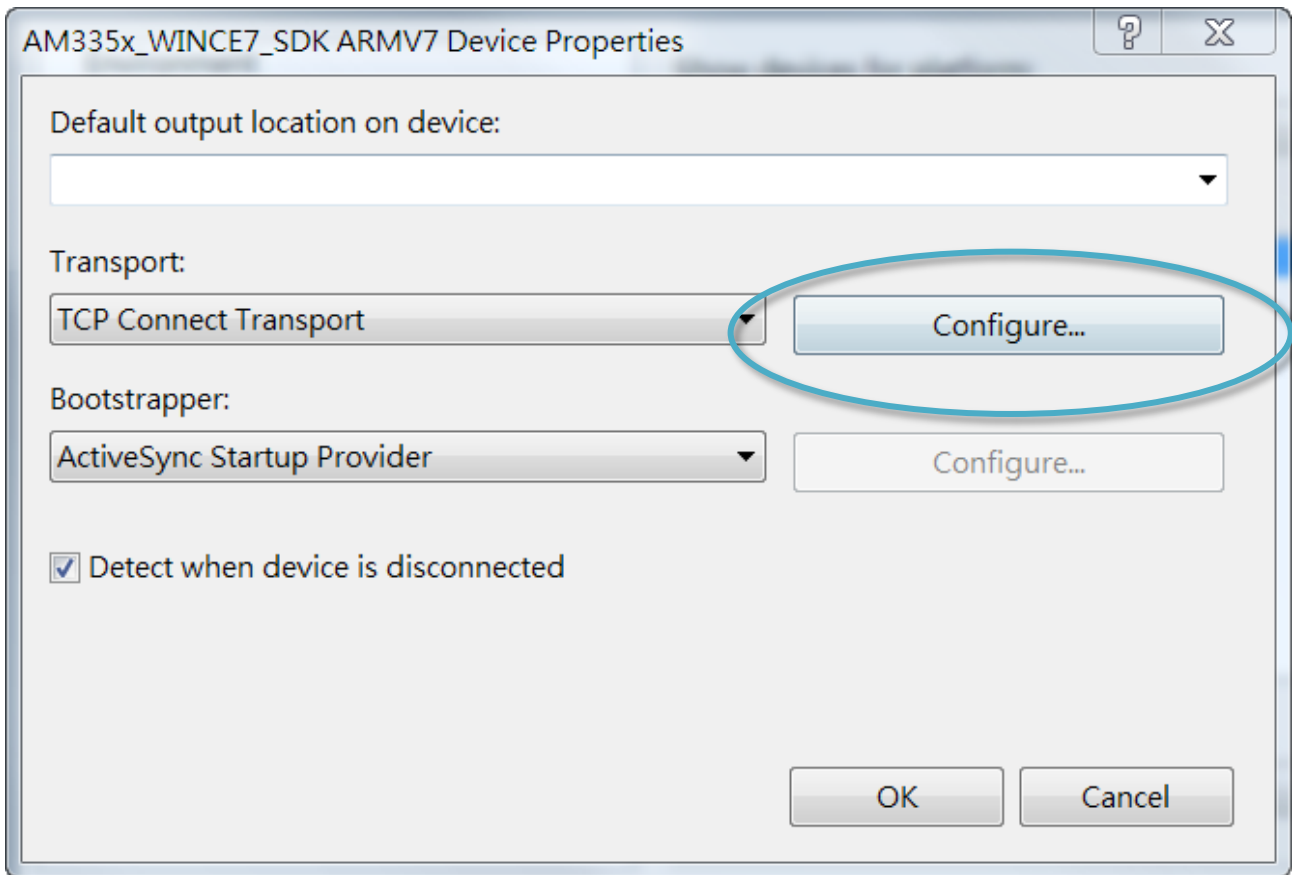

Step 7: Select the Use specific IP address:, and then type the IP address of VP-X201-CE7

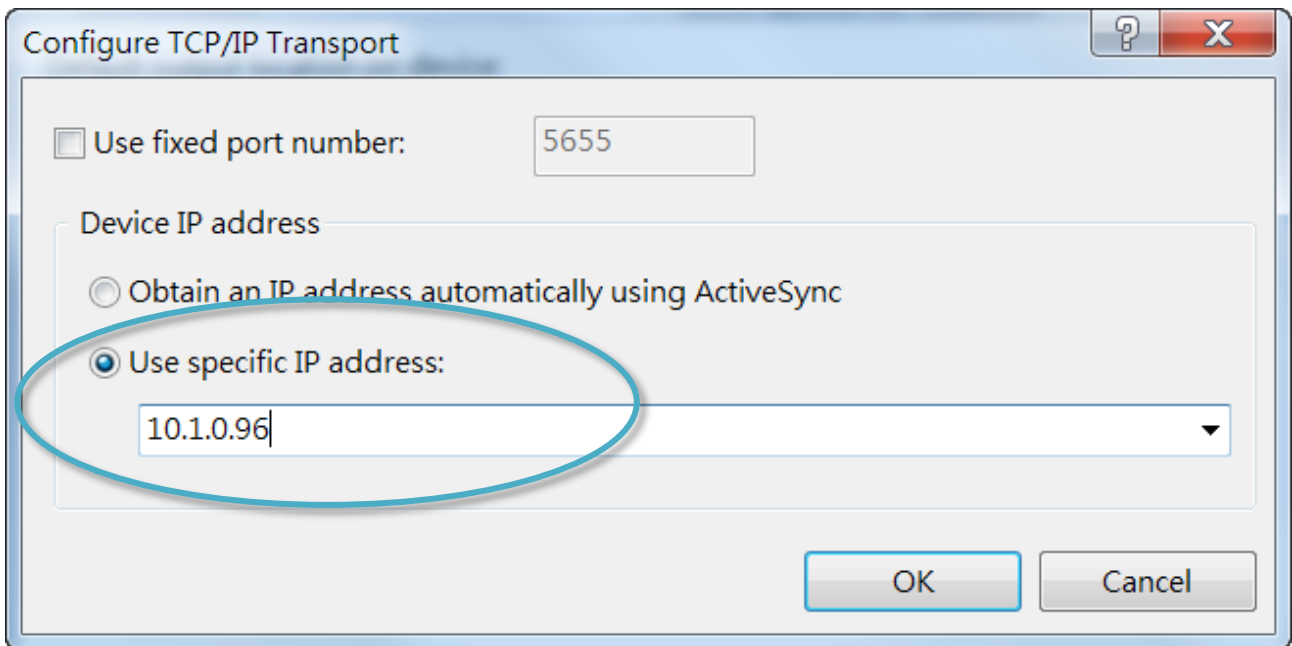

Step 8: Click the OK, and then click OK to end the dialog

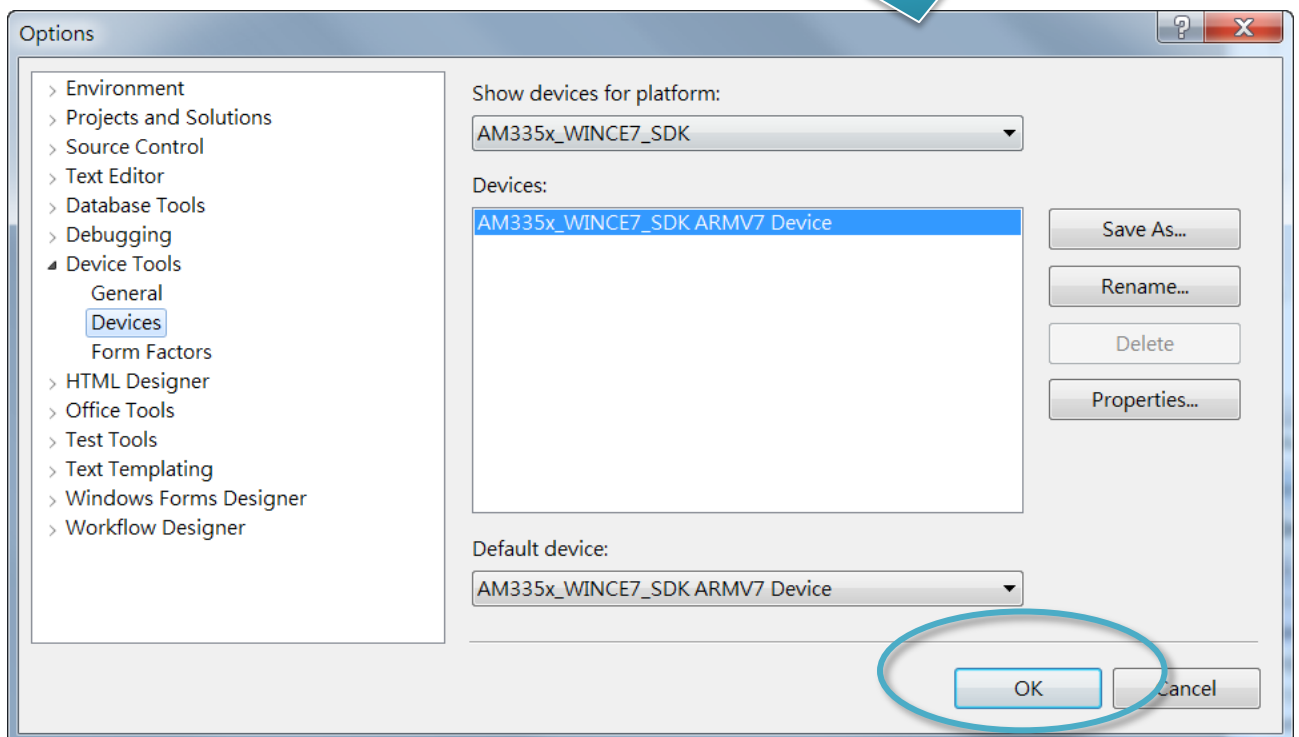
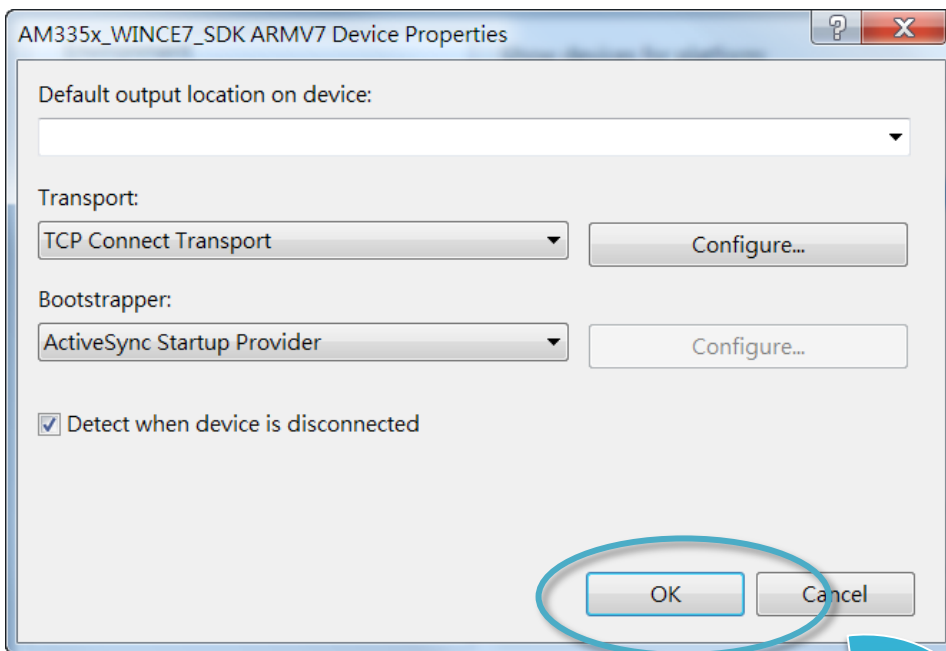

Step 9: On the Tools menu, click the Connect to Device...

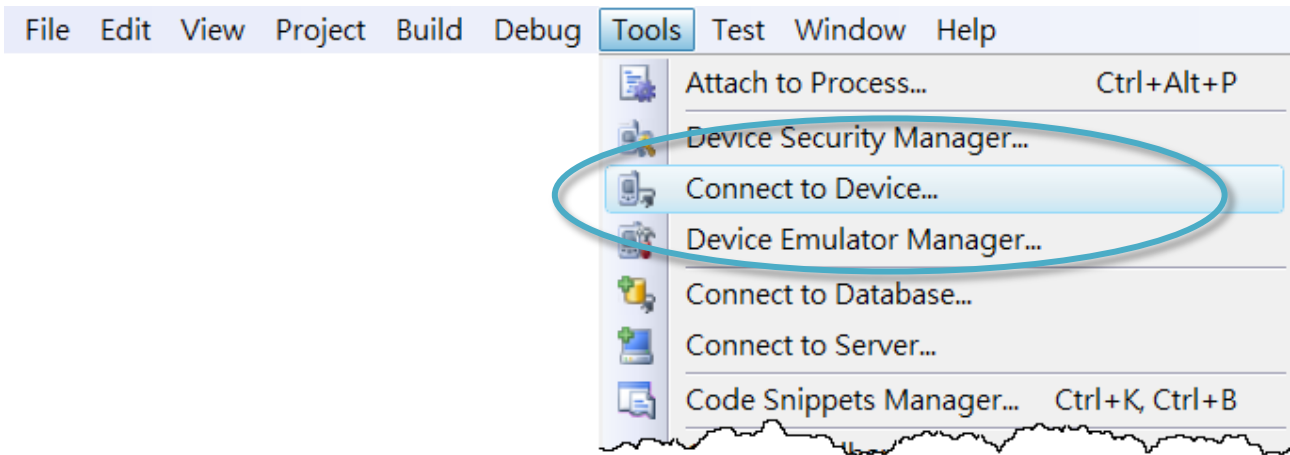

Step 10: Wait for the connection to be established

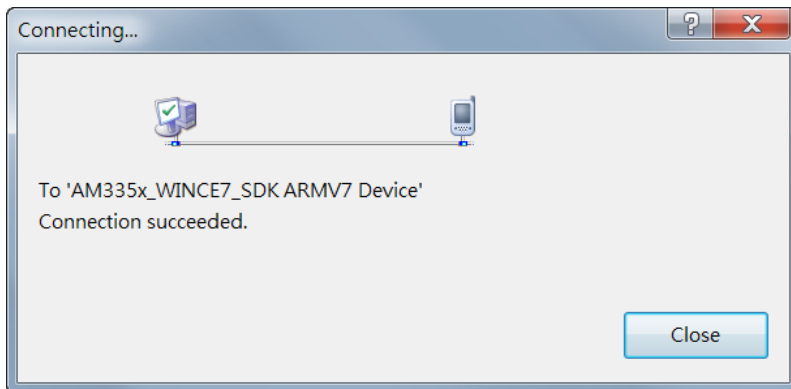

Tips & Warnings



If the connection fails, as shown below, please repeat the step 2 to step 9 to try it again.

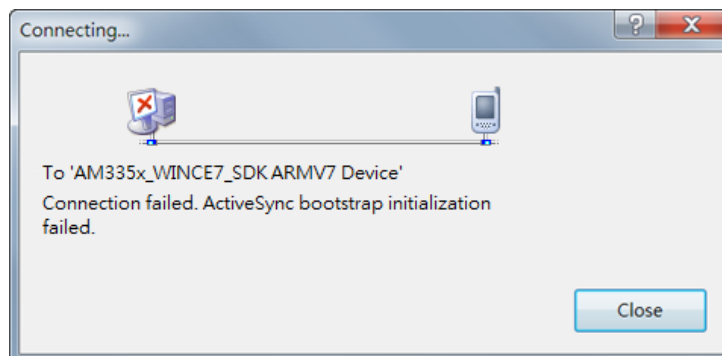

B. How to Automatically Synchronize VP-X201-CE7 Clock with an Internet Time Server

The clock on the VP-X201-CE7 can be synchronized with an internet time server. This means that the clock is updated to match the clock on the time server, which can help ensure that the time on the VP-X201-CE7 is accurate. Here are step by step instructions on how to synchronize the clock on the VP-X201-CE7 with an Internet time server.

Step 1: Run the PAC Utility



Step 2: On the General tab, press Configure button

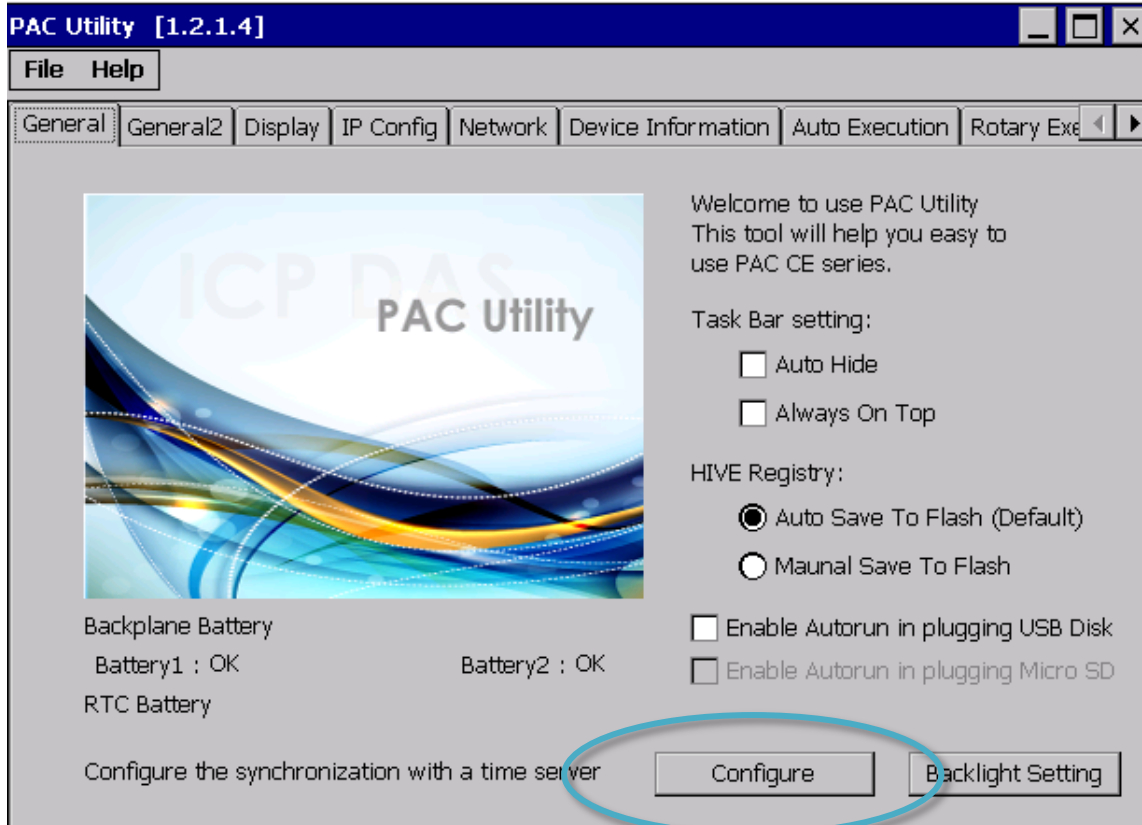

Step 3: Select the domain name from the Server drop-down list, and then enter a value in the Autoupdate Frequency field

Step 4: Check the Automatically synchronize with an internet time server check box

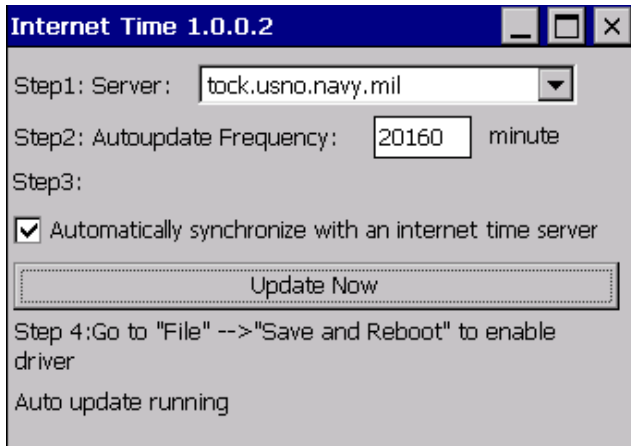

Step 5: On the File menu, click Save and Reboot

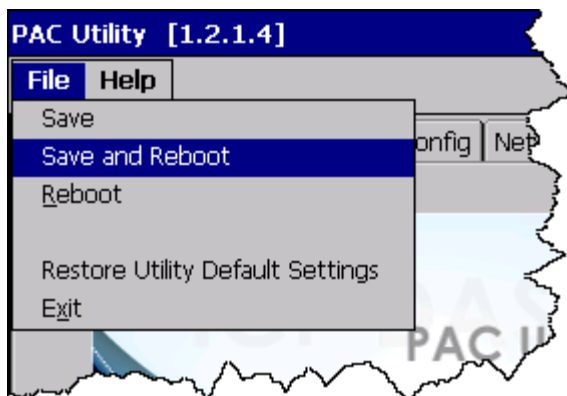

Step 6: The VP-X201-CE7 will automatically synchronize with an internet time server regularly

Step 7: Click the Update Now button to synchronize VP-X201-CE7 clock immediately

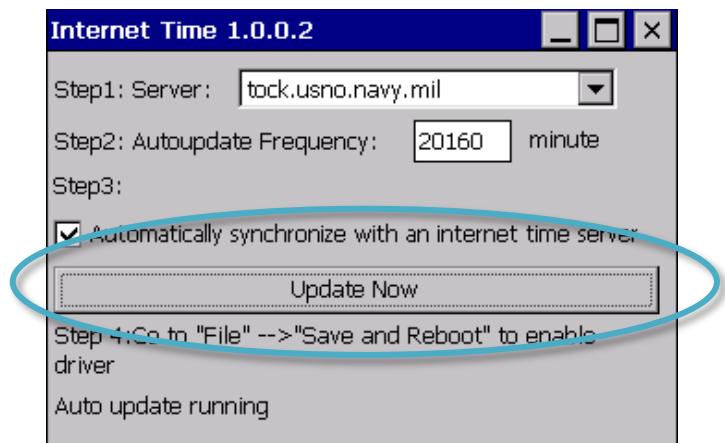

C. How to Control the User Account Control in VP-X201-CE7

User Account Control is a security feature that helps prevent unauthorized system changes to the VP-X201-CE7.

C.1. How to Create a User Account

Here are step by step instructions on how to add a user account.

Step 1: Run the PAC Utility



Step 2: On the Login tab of the Network tab, click Login tab, type the User Name and Password, and then click Add button

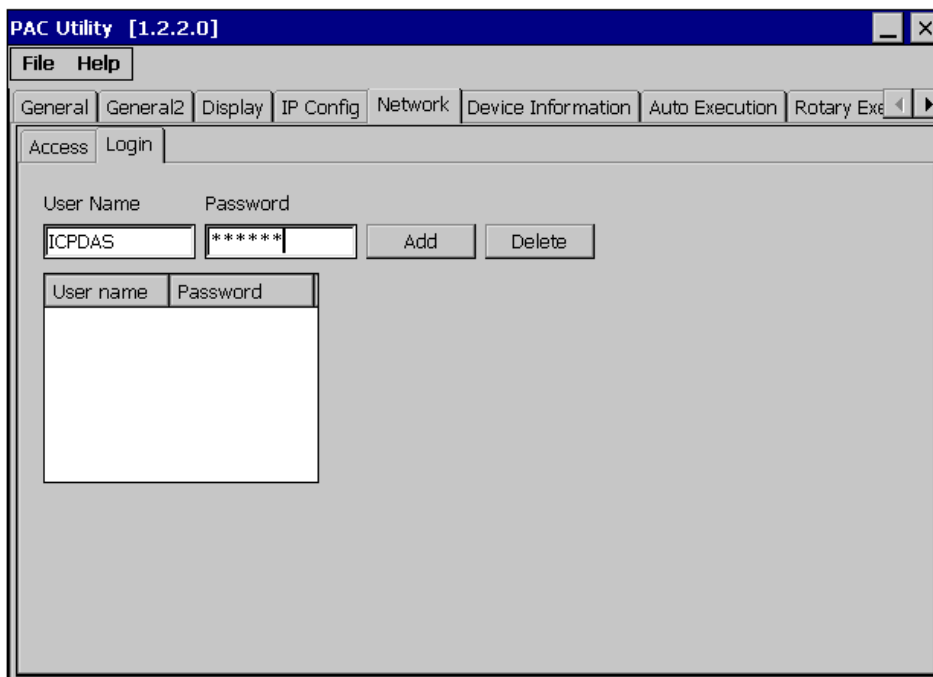

Step 3: The user has been added to the allowed under the remote login and included in the following list

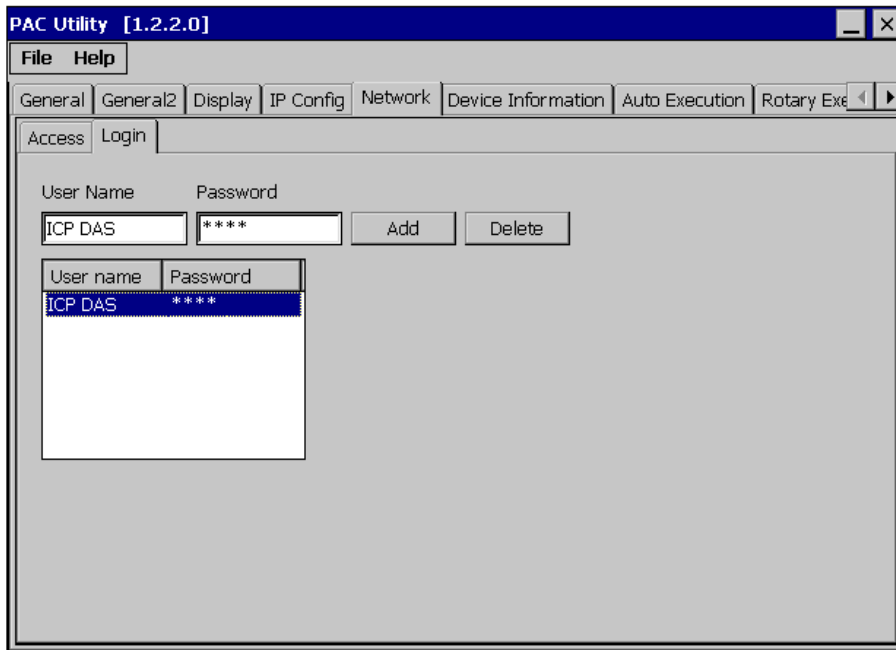

Step 4: On the File menu, click Save and Reboot for changes to take effect

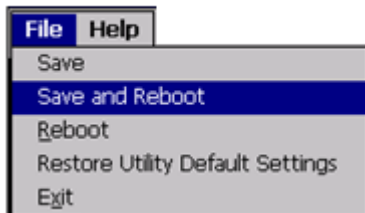

C.2. How to Use Telnet to Remote Login the ViewPAC from PC

Here are step by step instructions on how to use telnet to remote login the ViewPAC from PC.

Step 1: On the PC, open a MS-DOS command prompt

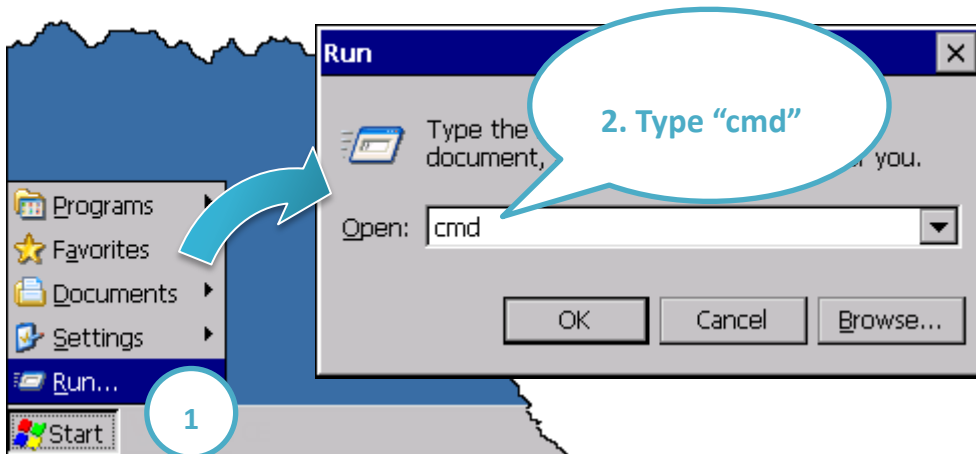

Step 2: At the command prompt, type "telnet (IP address)"

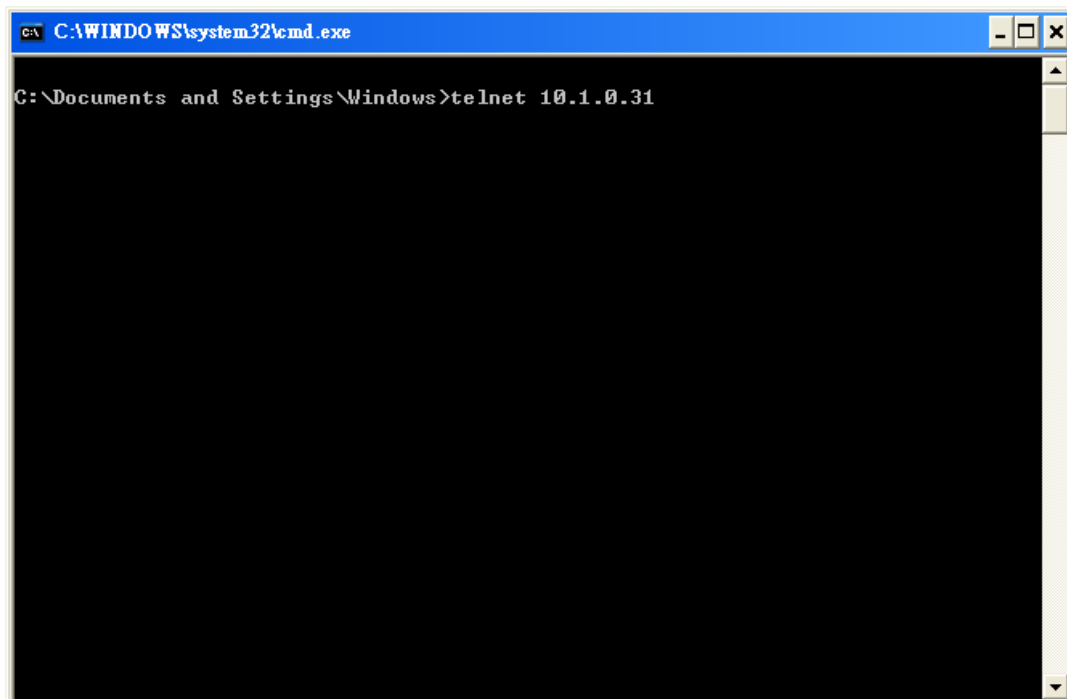

Step 3: The connection has been set up, and then type the name and password

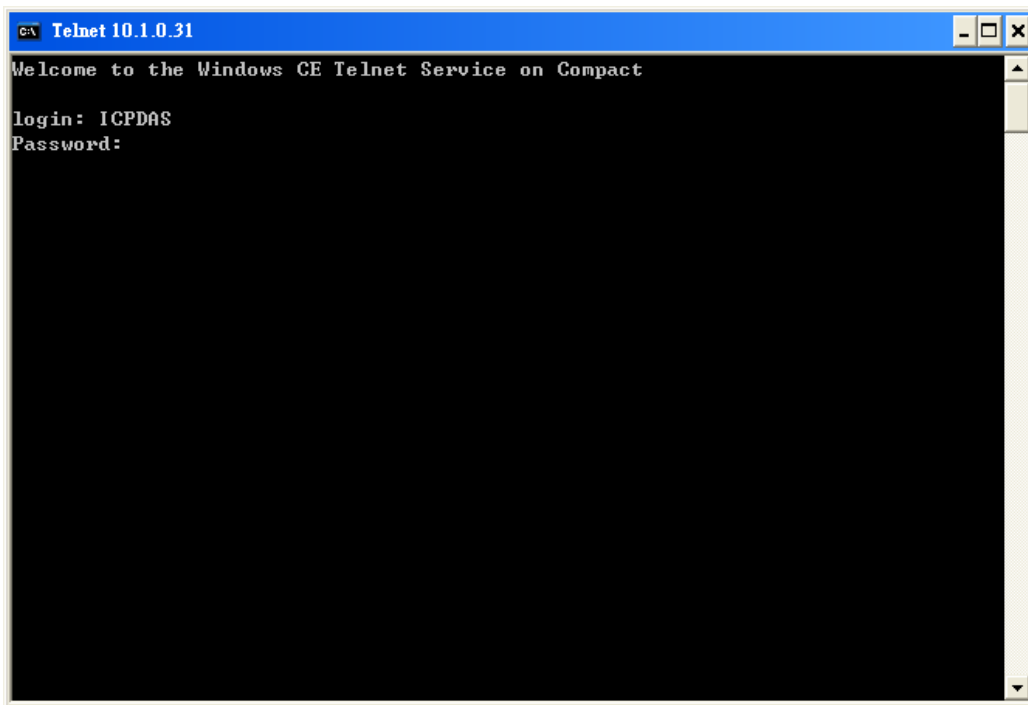

Step 4: The remote login has been completed

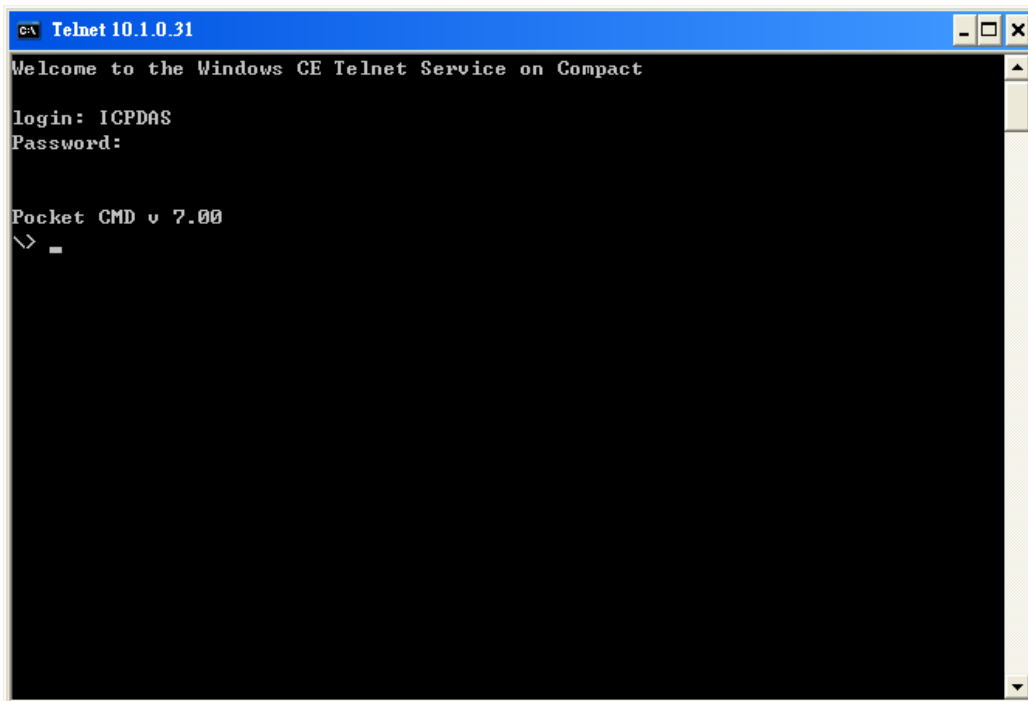

C.3. How to Remove a User Account from the Login List

Here are step by step instructions on how to remote the user from the login list.

Step 1: Click a user from the list which you want to remove, and the user will display in the field, and then press Delete to delete the user from the login list

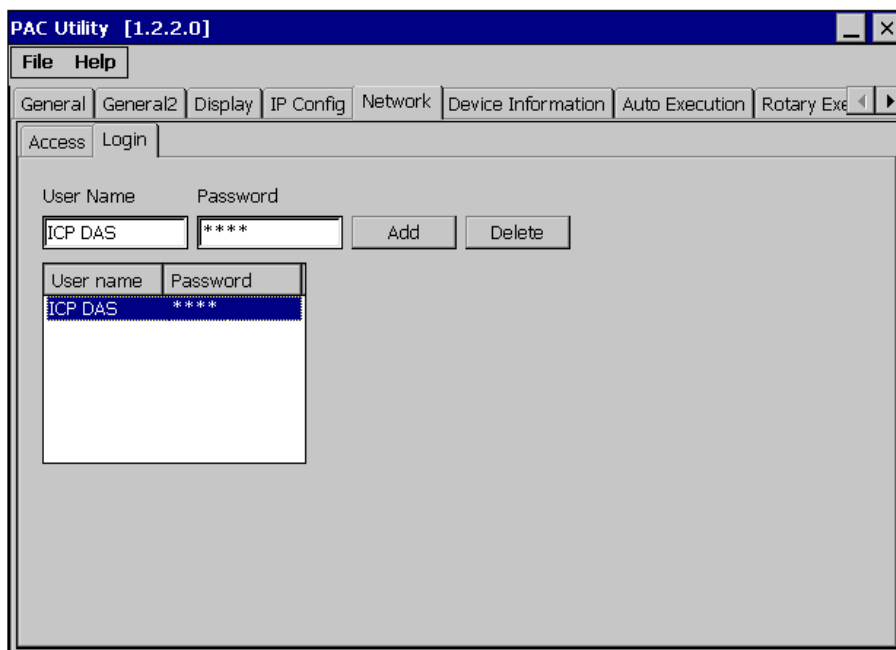

Step 2: On the File menu, click Save and Reboot for changes to take effect

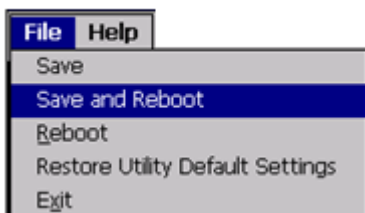

D. How to Use the Services Tool

The services tool can help you turn on, turn off and monitor the WinCE services.

Step 1: On the PC, open a MS-DOS command prompt

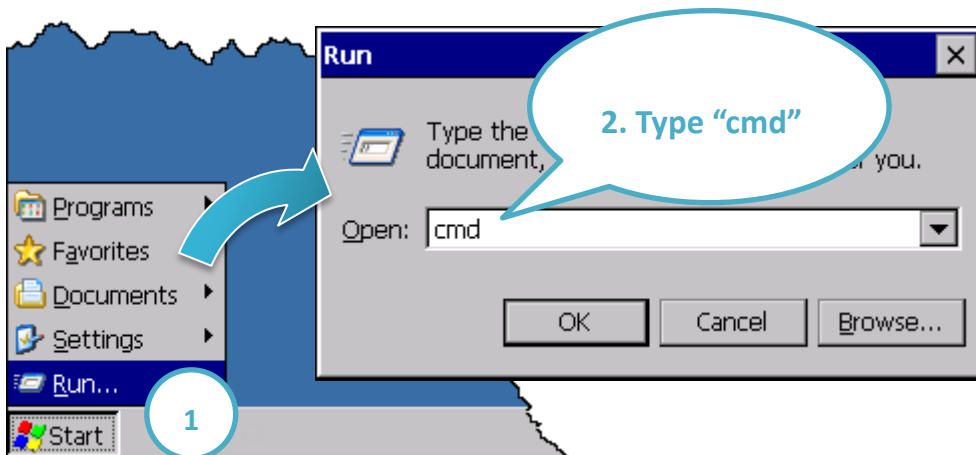

Step 2: List all services

[Syntax] services list

```
File Edit Help
Pocket CMD v 5.0
\> services list
NFYO: 0x00030110 NOTIFY.Dll Running
HTPO: 0x00031570 HTTPD.DLL Running
CRDO: 0x00032070 credsvc.dll Running
MMQ1: 0x00036790 MSMQD.Dll Off
OBX0: 0x00036b20 OBEXSrVr.dll Off
FTPO: 0x00037770 FTPD.Dll Running
TELO: 0x00037ac0 TELNETD.Dll Running
SMB0: 0x0003c3e0 smbserver.dll Running
NTPO: 0x0003fff0 timesvc.dll Running
\>
```

Step 3: Type the commands to configure service

[Syntax] services stop <services name>

For example, turn on the “FTP” service:

services stop FTPO:

```
File Edit Help
Pocket CMD v 5.0
\> services stop FTPO:
\> services list
NFYO: 0x00030110 NOTIFY.Dll Running
HTPO: 0x00031570 HTTPD.DLL Running
CRDO: 0x00032070 credsvc.dll Running
MMQ1: 0x00036790 MSMQD.Dll Off
OBX0: 0x00036b20 OBEXSrVr.dll Off
FTPO: 0x00037770 FTPD.Dll Off
TELO: 0x00037ac0 TELNETD.Dll Running
SMB0: 0x0003c3e0 smbserver.dll Running
NTP0: 0x0003fff0 timesvc.dll Running
\>
```

Tips & Warnings



For more information about using services tool, just type “services help”

```
File Edit Help
Pocket CMD v 5.0
\> services help
Commands:
    help - print this text
    list - lists loaded services
    load <service name> - activates a service that is inactive
    stop <service instance> stops/pauses a service (does not unload)
    start <service instance> - starts/resumes a service
    refresh <service instance> - causes service to refresh its configuration
    unload <service instance> - causes service to be unloaded and
    register <service name> - service will be automatically loaded at boot
eboot
    unregister <service name> - service will not be automatically loaded
next reboot
    command <service name> [arg1 arg2 ...] - send service-specific commands
o service
    help <service name> - get information on what service-specific commands
are supported

    <service name> - service's name in the registry (i.e. HTTPD)
    <service instance> - particular instantiation (i.e. HTPO:)

Flags:
    -f <file name>
    -s silent
    -d output to debugger
\>
```

E. How to Set DIP Switch for COM Port Communication

E1. RS-232/RS-485 Communication Type

The RS-232 is a point to point serial communication interface, while the RS-485 is a multiple point interface consists of a single master device and one or more slave devices.

The COM1 and COM2 of the VP-x201-CE7 provide RS-232 and RS-485 communication types, while the COM3 provides RS-485 communication type only. The DIP switch can be used to assign communication types; three kinds of communication type are available.

A. RS-232 Communication

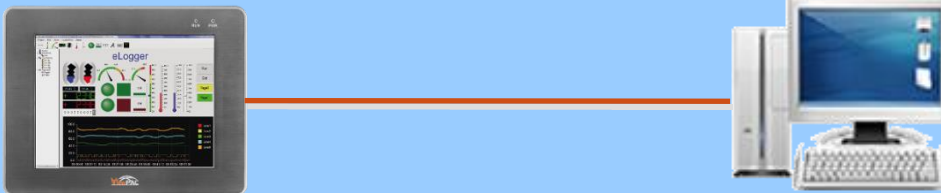

COM1		COM1 RS-232 Mode: On
COM2		COM2 RS-232 Mode: On

B. RS-485 Master



COM1		RS-485 Pull Mode : ON (Master, default)
COM2		RS-485 Pull Mode : ON (Master, default)

C. RS-485 Slave



COM1		RS-485 Pull Mode : OFF (Slave)
COM2		RS-485 Pull Mode : OFF (Slave)

E2. COM1/COM2/COM3 RS-485 Slave Terminal Resistance 120Ω:

RS-485 is designed to transmit data and information over twisted- pair wire with a characteristic impedance of 120 Ω recommended. If the total length of the communication bus longer than 100 m, a terminating resistor with the same value as the characteristic impedance of the twisted pair needs to be placed at the two ends of the cable to prevent adverse transmission-line phenomena, such as reflections.

Suppose all devices are connected on the COM 1:

A. RS-485 < 100m

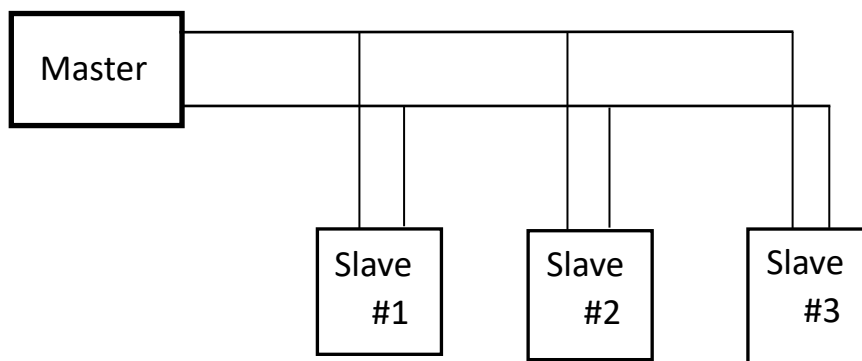

Master		<ul style="list-style-type: none"> - RS-485 Pull Mode : ON (Master, default) - RS-485 Slave Terminal Resistance 120 Ω: OFF (default)
Slave #1,2,3		<ul style="list-style-type: none"> - RS-485 Pull Mode : OFF (Slave) - RS-485 Slave Terminal Resistance 120 Ω: OFF (default)

B. RS-485 > 100m

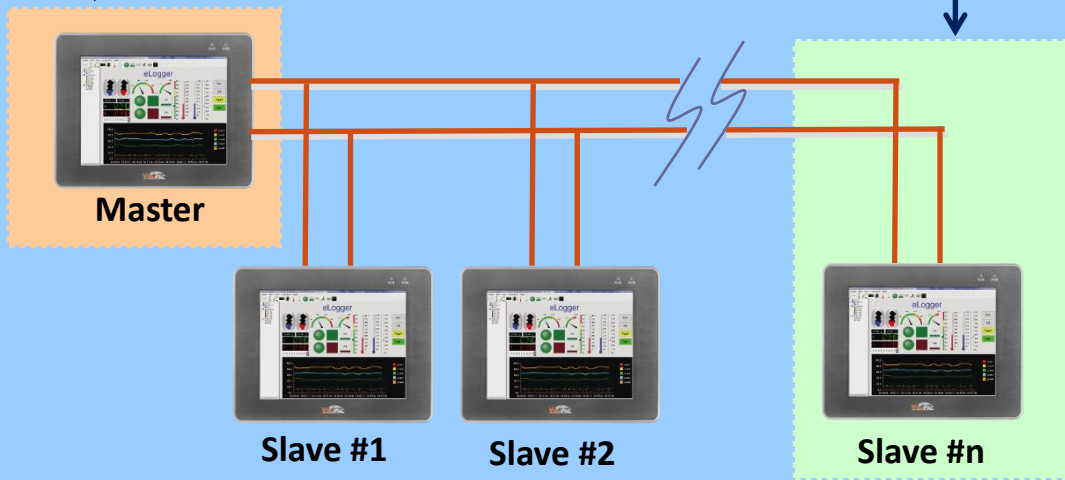
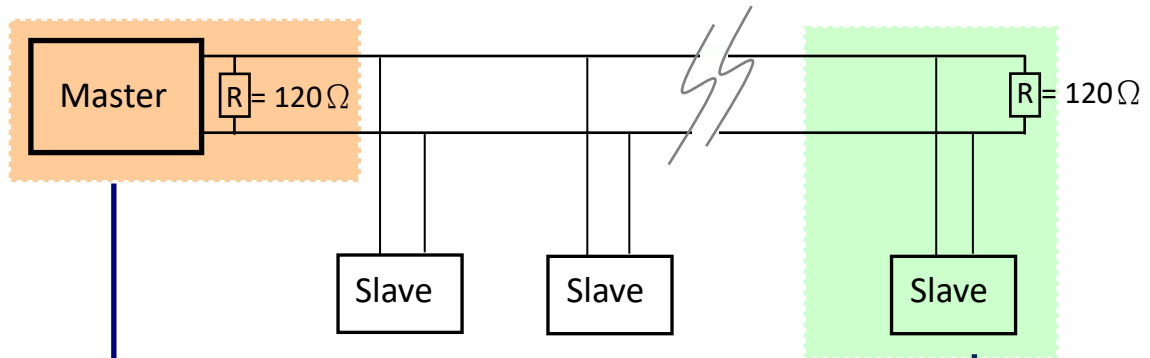

Master		<ul style="list-style-type: none"> - RS-485 Pull Mode : ON (Master, default) - RS-485 Slave Terminal Resistance 120 Ω: ON
Slave #1,2		<ul style="list-style-type: none"> - RS-485 Pull Mode : OFF (Slave) - RS-485 Slave Terminal Resistance 120 Ω: OFF (default)
Slave #n		<ul style="list-style-type: none"> - RS-485 Pull Mode : OFF (Slave) - RS-485 Slave Terminal Resistance 120 Ω: ON

F. Revision History

This chapter provides revision history information to this document.

The table below shows the revision history.

Revision	Date	Description
1.0.0	February 2016	Initial issue
1.0.1	December 2017	- Added description for DIP Switch in sec.1.3.2. - Added section "E. How to Set DIP Switch for COM port Communication" in chapter "Tips & How to".