

iSN-101

Liquid Leak Detection Module

User Manual



iSN-101



iSN-101/DIN

Version: 1.0.0

Date: Aug. 2018

Edited by Jerry Tseng

Warranty

All products manufactured by ICP DAS are warranted against defective materials for a period of one year from the date of delivery to the original purchaser.

Warning

ICP DAS assumes no liability for damages consequent to the use of this product. ICP DAS reserves the right to change this manual at any time without notice. The information furnished by ICP DAS is believed to be accurate and reliable. However, no responsibility is assumed by ICP DAS for its use, not for any infringements of patents or other rights of third parties resulting from its use.

Copyright

Copyright © 2018 by ICP DAS. All rights are reserved.

Contact Us

If you have any questions, please feel free to contact us via email at:

Service@icpdas.com

Contents

1. Introduction.....	4
2. Hardware	6
2.1 Specifications	6
2.2 Appearance.....	7
2.3 Pin Assignments	8
2.4 Wire Connections	9
2.5 Application	10
2.6 DIP Switch and Jumper Settings	12
2.7 Connector for Power/ RS-485 / Water Sense Cable / Relay Output	12
2.8 Dimensions (unit: mm)	16
3. Configuration via RS-485.....	17
Appendix A: DCON Command Sets	24
A-1. iSN-101 DCON Command Sets.....	24
Appendix B: ModbusMasterToolPC.....	27
Appendix C: Modbus Address Table	31
C-1. iSN-101 Modbus Address Mappings (Base 1).....	31
Revision History	33

1. Introduction

The iSN-101 Liquid Leak Detection Module is a low-cost intelligent liquid leak detection device that can be used to directly control Relay Output. No additional conversion module is needed and the iSN-101 can be easily integrated with a variety of monitoring systems to achieve remote alarm and remote device control. The iSN-101 Liquid Leak Detection module can be used to monitor double-core leader cable lengths of up to 500 meters, and can be used with both the sensor cable and its included water leakage probe. If liquid is detected, the controller immediately activates the output relay - the normally open, normally closed passive output signal. The module can be easily integrated with other collection hosts connected to the network. The iSN-101 is suitable for real-time leak detection in critical locations, such as computer room base stations, warehouses, libraries, museums and industrial sites, and also for air handling equipment, refrigeration units, liquid containers, or pump tanks, etc., where there is a need to monitor any leakage of the equipment.

When required, communication with the iSN-101 can be programmed based on the Modbus RTU protocol, with the added benefit that different addresses can be configured via hardware to allow for Modbus RTU communication.

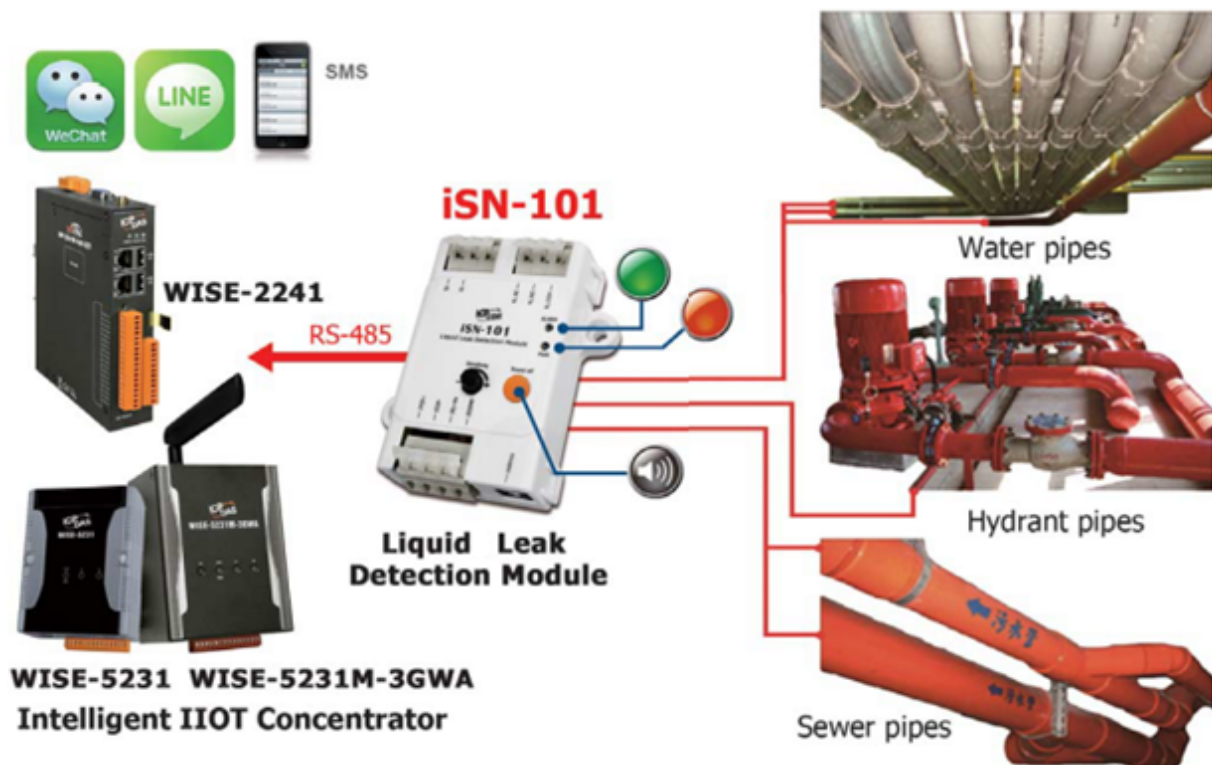

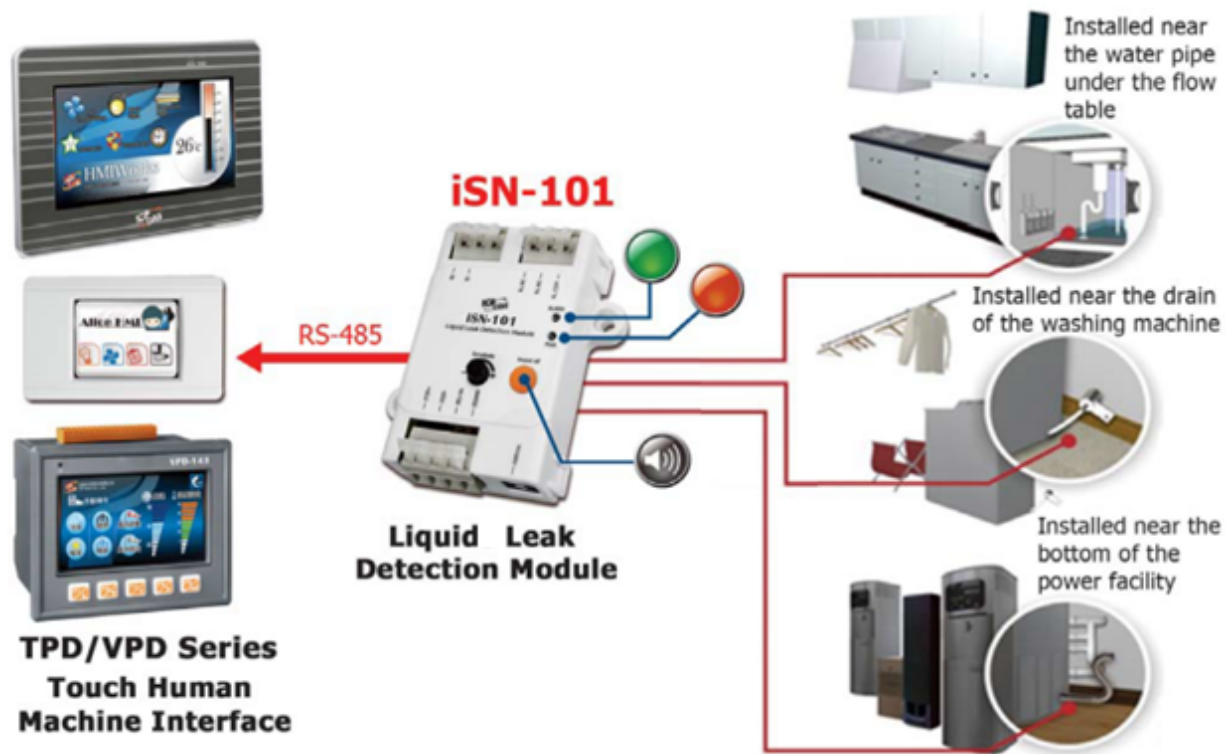

Features

- ▶ Leak detection triggers and audible alarm
- ▶ A mute button to silence the alarm
- ▶ Two LED indicators to display the status of the power and the alarm
- ▶ A configurable Output Relay
- ▶ Leader cables and Sensor Cable can be up to 500 meters.
- ▶ Adjustable detection sensitivity
- ▶ Supports the DCON and the Modbus RTU Protocols
- ▶ Embedded Dual Watchdog
- ▶ Wide Operating Temperature Range: -25 to +75°C
- ▶ Tiny Form Factor with Easy Screw Mounting

2. Hardware

2.1 Specifications

Model	iSN-101
Analog Input	
Channel	1
Wiring Cables Length	500 meters(include sense cable)
Adjustment of the Detection Sensitivity	26K Ω ~580K Ω
Communication	
Interface	RS-485
Data Format	N,8,1 / O,8,1 / E,8,1 / N,8,2
Baud Rate	Software Configuration: 1200 ~ 115200 bps
Protocol	Modbus RTU or DCON
Node Addresses	96 ~ 127 for hardware configuration 0 ~ 255 for software configuration
LED Indicators	
Power	1 as Power Indicator (Green LED)
Alarm	1 as Alarm Indicator (Red LED)
Audible alarm	
Audible alarm	70 dB Audible alarm with silence button
Relay Output	
Form C Relay	0.5 A @ 125 VAC 2 A @ 30 VDC
EMS Protection	
ESD (IEC 61000-4-2)	\pm 8 kV Air for Random Point
EFT (IEC 61000-4-4)	\pm 4 kV for Power
Power Requirements	
Reverse Polarity Protection	Yes
Input Voltage Range	+10 ~ +30 VDC
Consumption	1.5 W Max.
Mechanical	
Dimensions (L x W x H)	83 mm x 70 mm x 29 mm
Installation	Screw Mounting or DIN-Rail

Environment	
Operating Temperature	0 ~ +50°C
Storage Temperature	-30 ~ +75°C
Humidity	10 ~ 90% RH, Non-condensing

2.2 Appearance

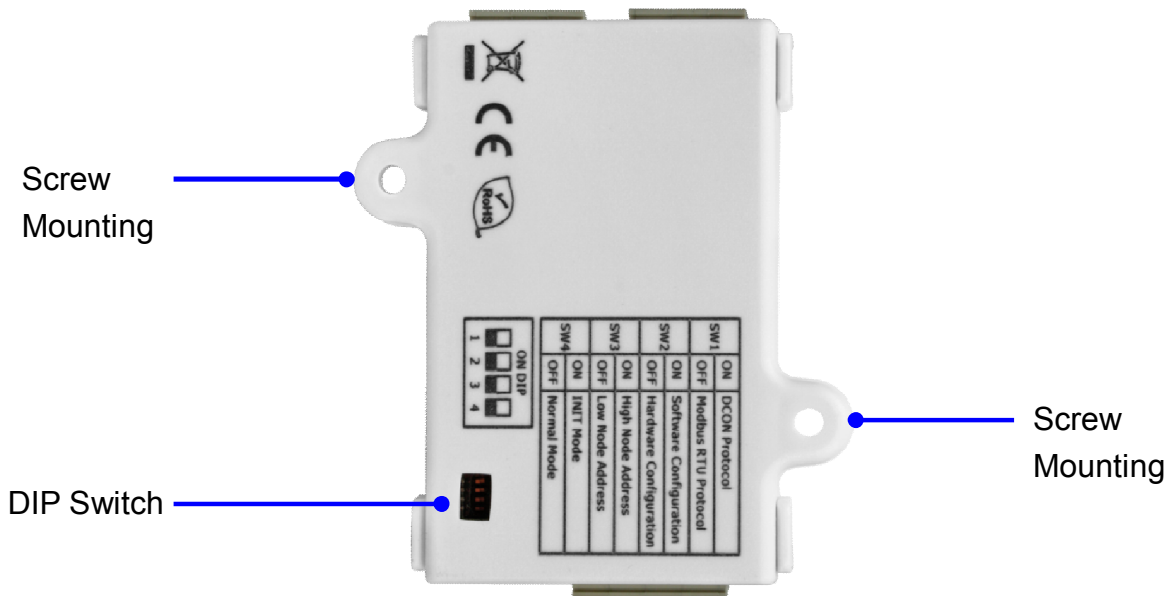
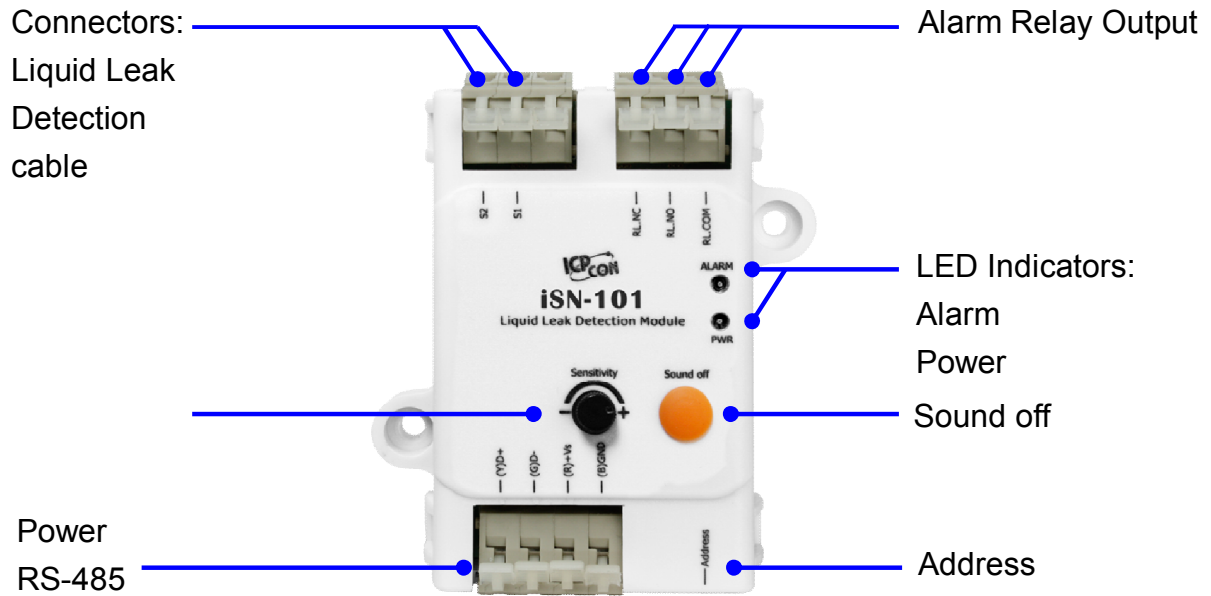

LED Indicators

The two LED indicators from up to down are:

- ▶ Alarm: red for alarm condition.
- ▶ PWR: green for normal operation.

Sound off Button

The button is used to stop the audible alarm.

Audible alarm

70 dB Audible alarm with silence button

Sensitivity Adjustment

Sensitivity Adjustment Range: 26KΩ ~ 580KΩ



2.3 Pin Assignments

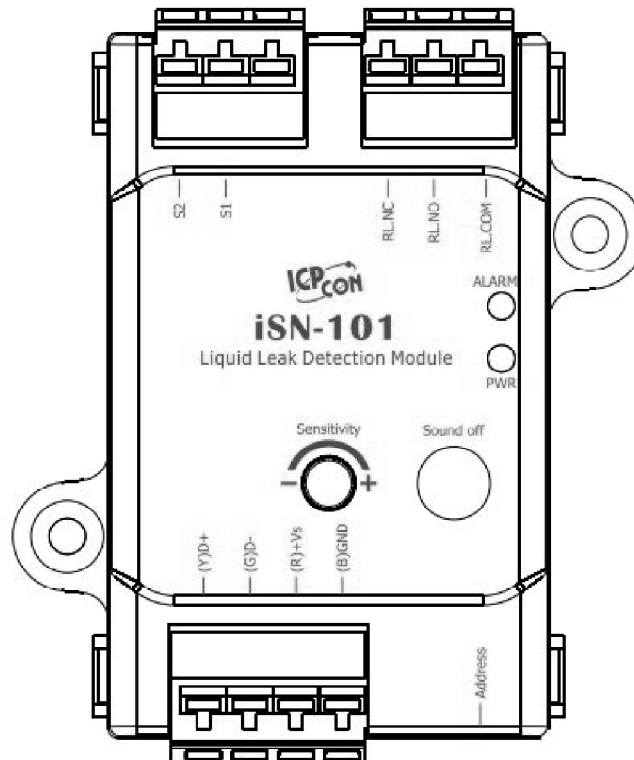

2.4 Wire Connections

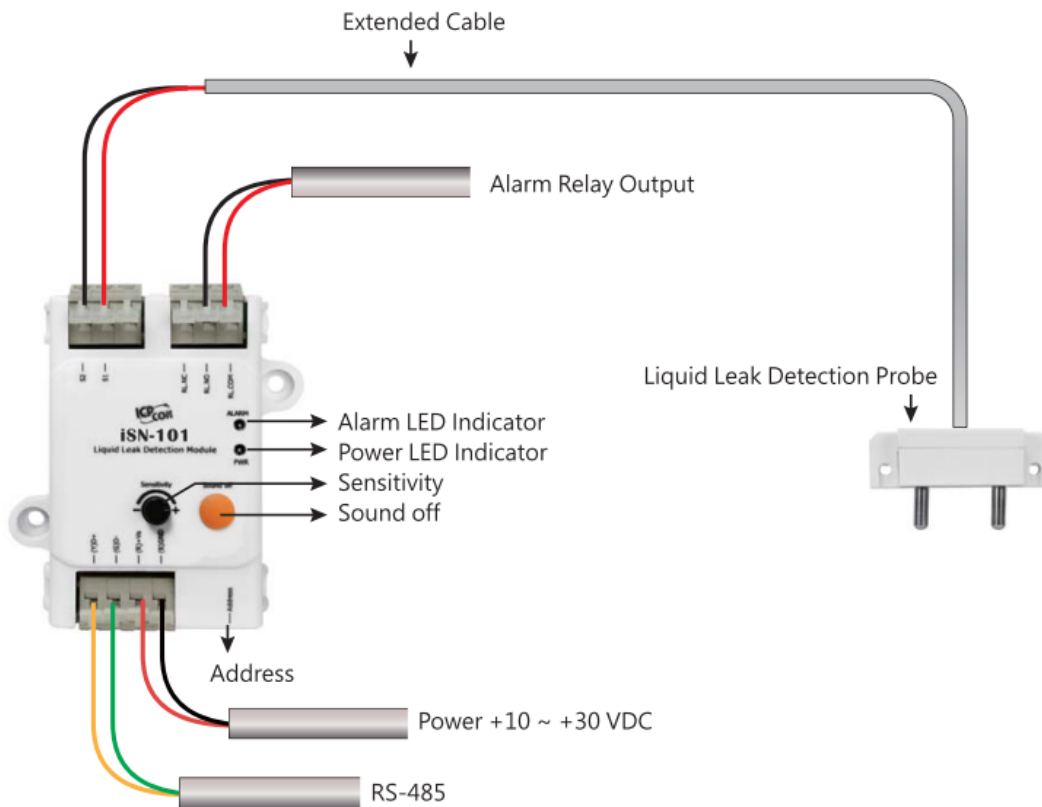
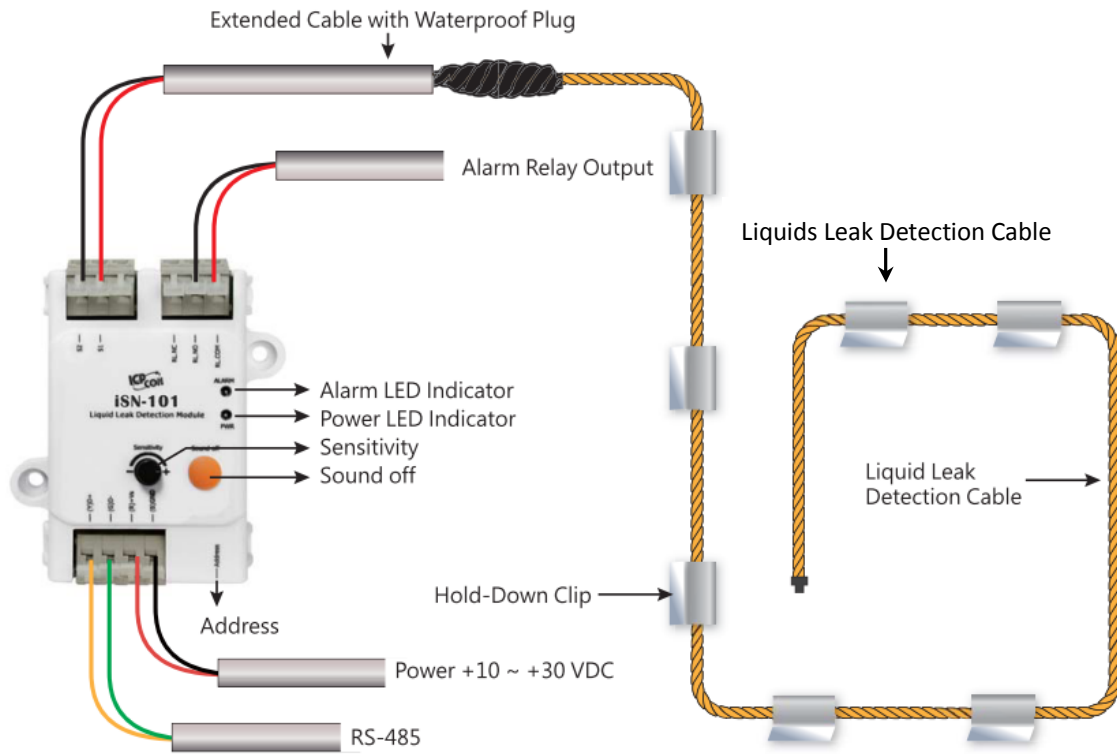

2.5 Application

Water Sense Cable

Water sense cable is designed to detect leaks over a wider area, and the path of the leak is not easily predetermined. The Water sense cable is ideal for open areas. The water sense cable can even be fixed directly to the water supply and return lines. Water sense cable is suitable for larger surface areas with multiple leak points.

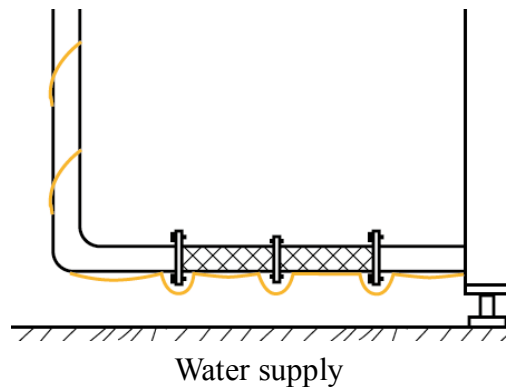
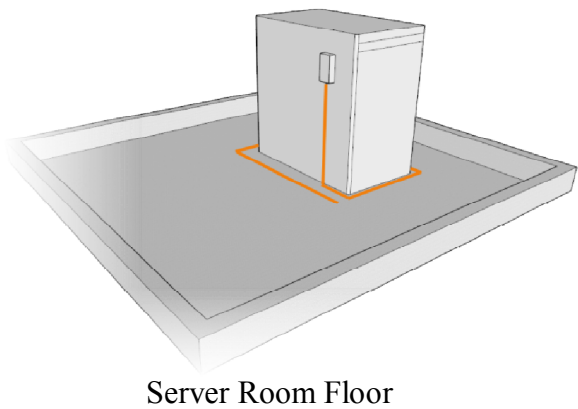
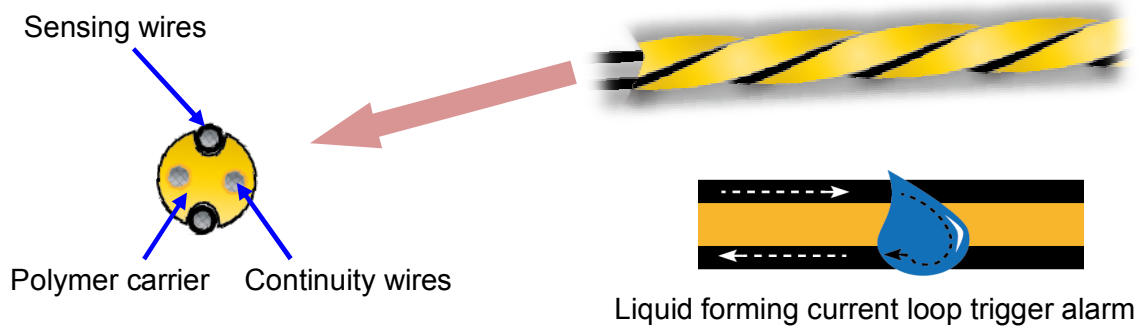

Water leakage probe

Water leakage probe are designed to detect leaks at specific locations and specific water levels.

The base of the Water leakage probe has two probes. To detect a leak, the water must touch both probes at the same time, thus completing a circuit and triggering an alarm. Water leakage probe are ideal for drains, Water storage tank, containers and other restricted areas.

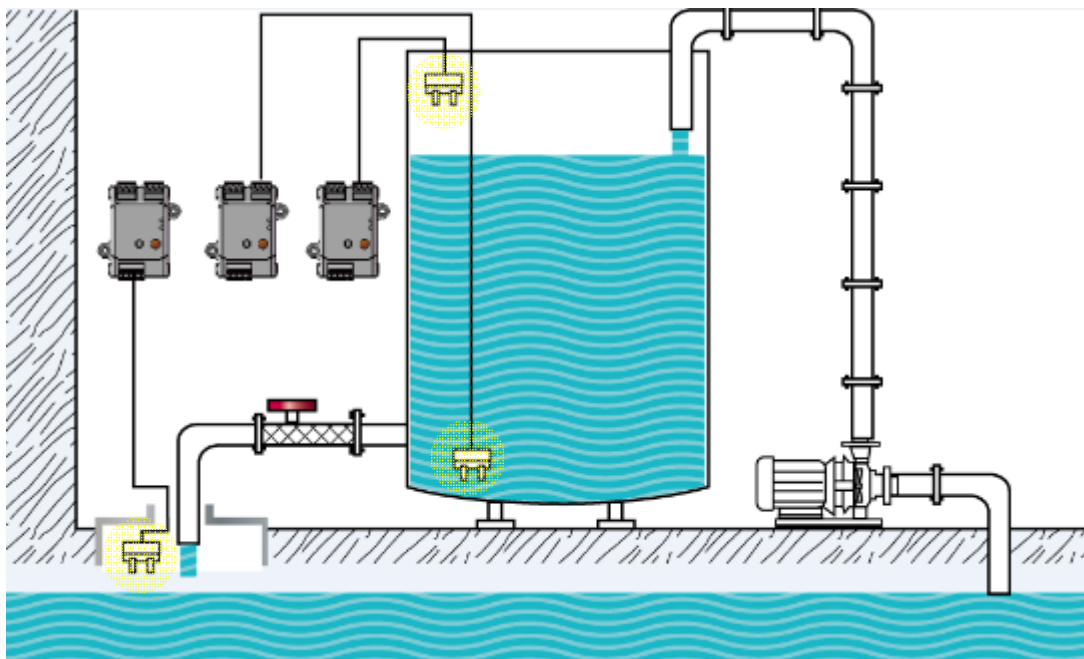
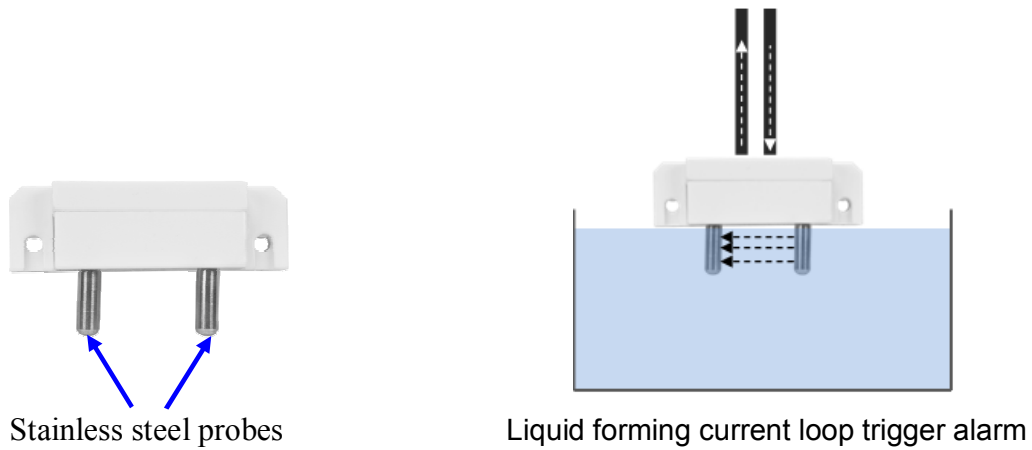

iSN-101 senses various water levels through the water leakage probe

2.6 DIP Switch and Jumper Settings

	SW1	ON	DCON Protocol
		OFF	Modbus RTU Protocol
	SW2	ON	Software Configuration
		OFF	Hardware Configuration
	SW3	ON	High Node Address
		OFF	Low Node Address
	SW4	ON	INIT Mode
		OFF	Normal Mode

Address Settings via Hardware Configuration

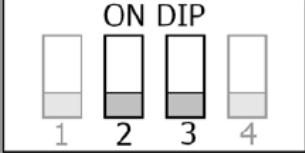
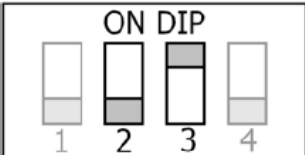
		0 ~ F for Addresses 96 ~ 111 (Low Node Address)
		0 ~ F for Addresses 112 ~ 127 (High Node Address)

2.7 Connector for Power/ RS-485 / Water Sense Cable / Relay Output

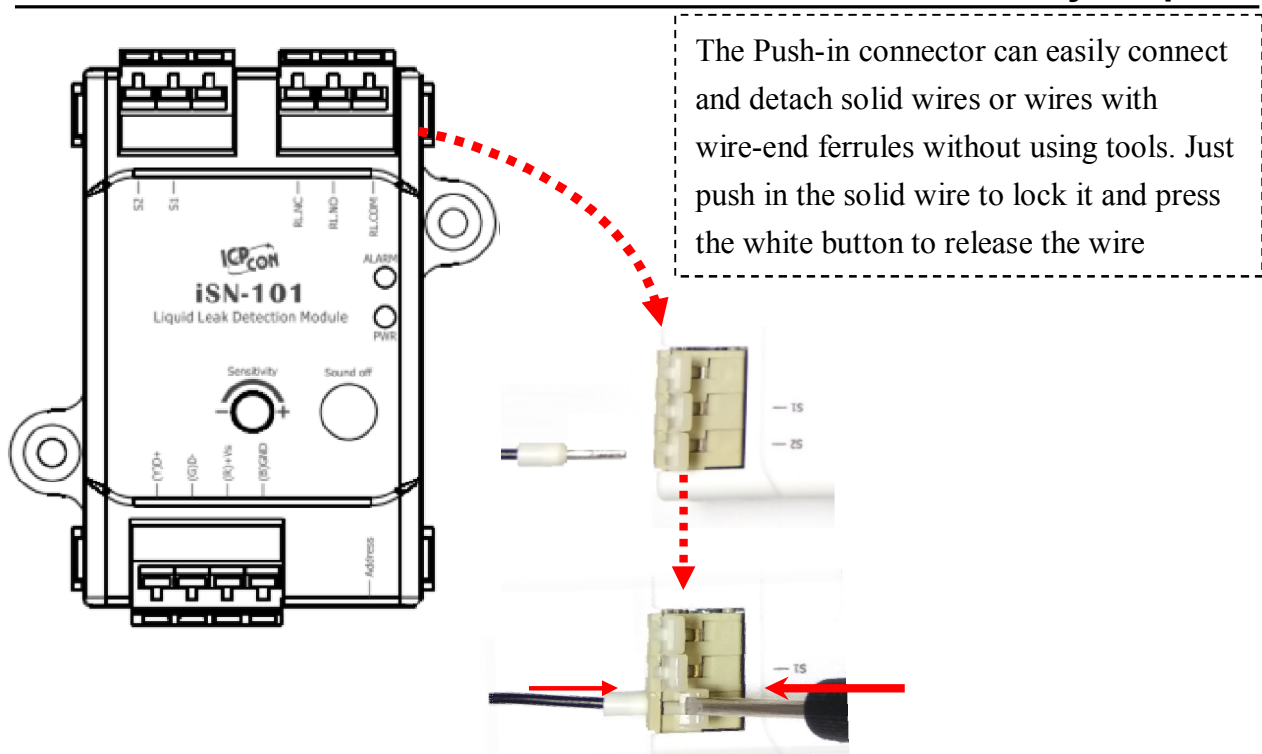

Connect the Leader Plug to Water Sense Plug



The fool-proofing groove (as red circle) is useful for easy connection of Water Sense Plug and Leader Plug. Please make sure they are located in the same direction when connecting these two items.



Make sure to tighten firmly



Connect the Leakage Probe with Wires



Take off cover

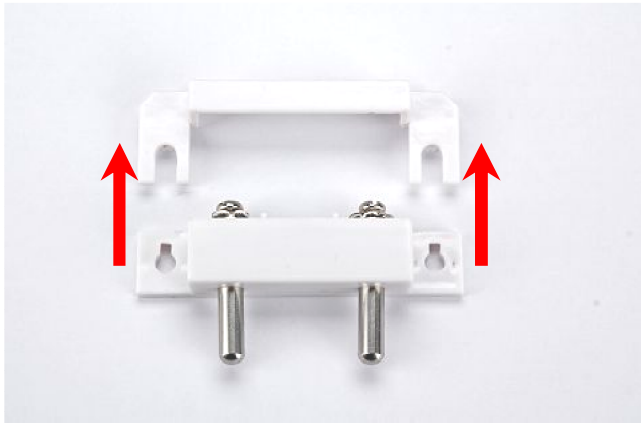

Put wire and tighten the screw down

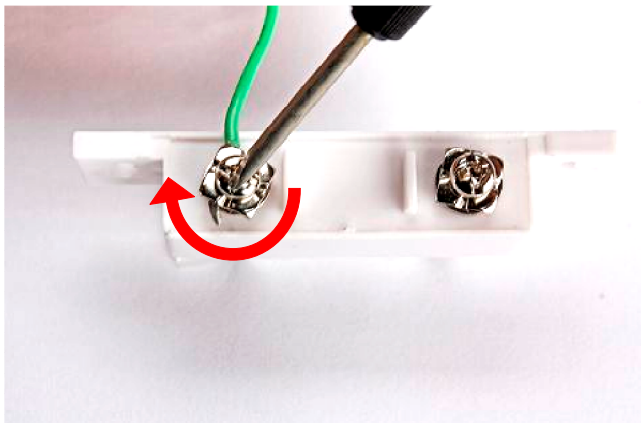
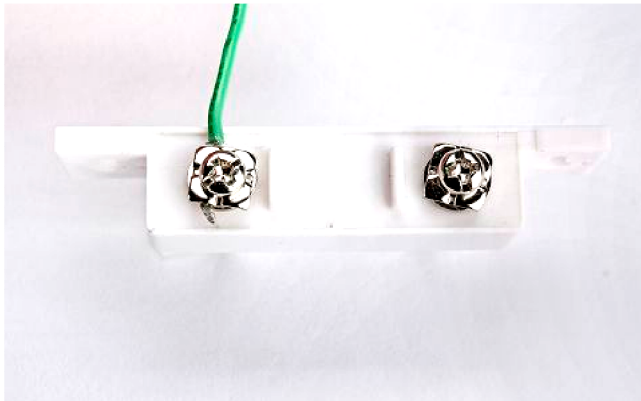

Put cover back

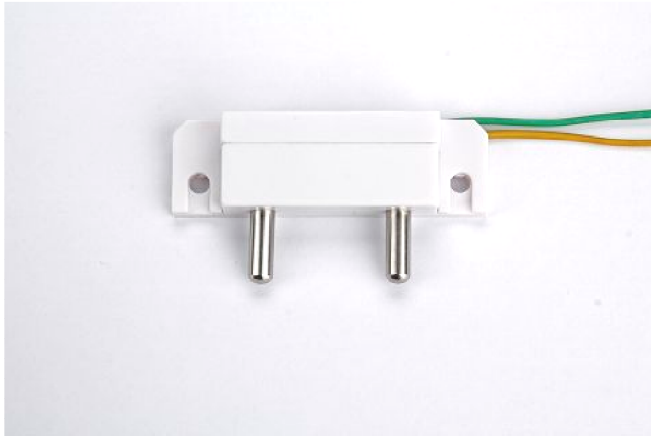

Install the two mounting screws into the 2 keyhole mounting holes.

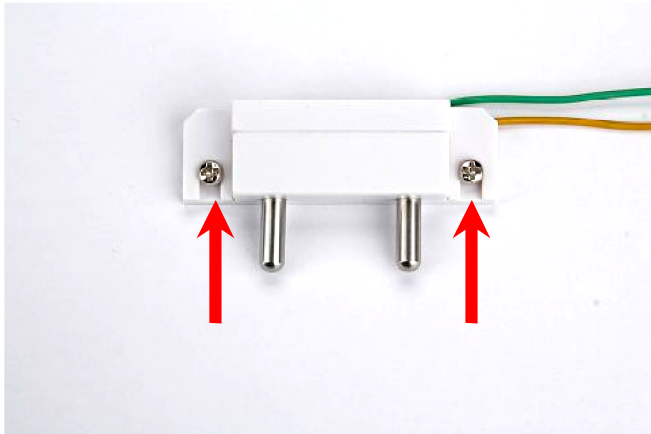

Relay Output Wire Connection

Output Type	ON State Readback as 1	OFF State Readback as 0
Relay Output		

2.8 Dimensions (unit: mm)

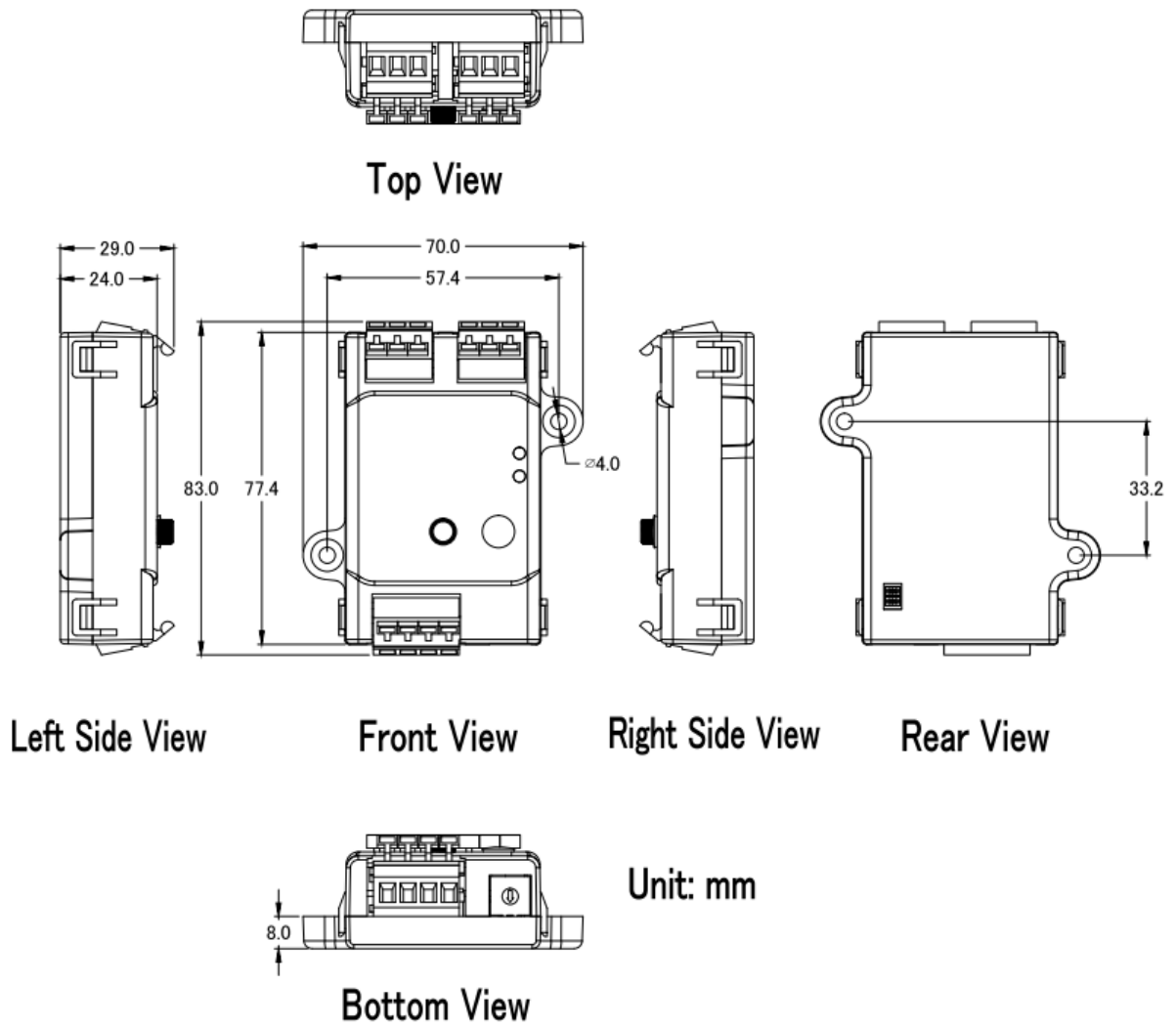

3. Configuration via RS-485

- The factory default settings for RS-485 communication
 - Address: 1
 - Protocol: Modbus/RTU
 - Baudrate: 9600
 - Parity: N,8,1
 - Response Delay (ms): 0

Note

If there are multiple iSN-101 connected to the same RS-485 network, each module needs be set with a unique RS-485 address. More than one module having the same address will cause communication failure

- Testing RS-485 Communication
 1. Download the DCON Utility Pro from
CD:\Napdos\iSN-101\utility\DCON_utility_pro or
http://ftp.icpdas.com/pub/cd/usbcd/napdos/iSN-101/utility/dcon_utility_pro

2. Launch the DCON_Utility_Pro.exe.

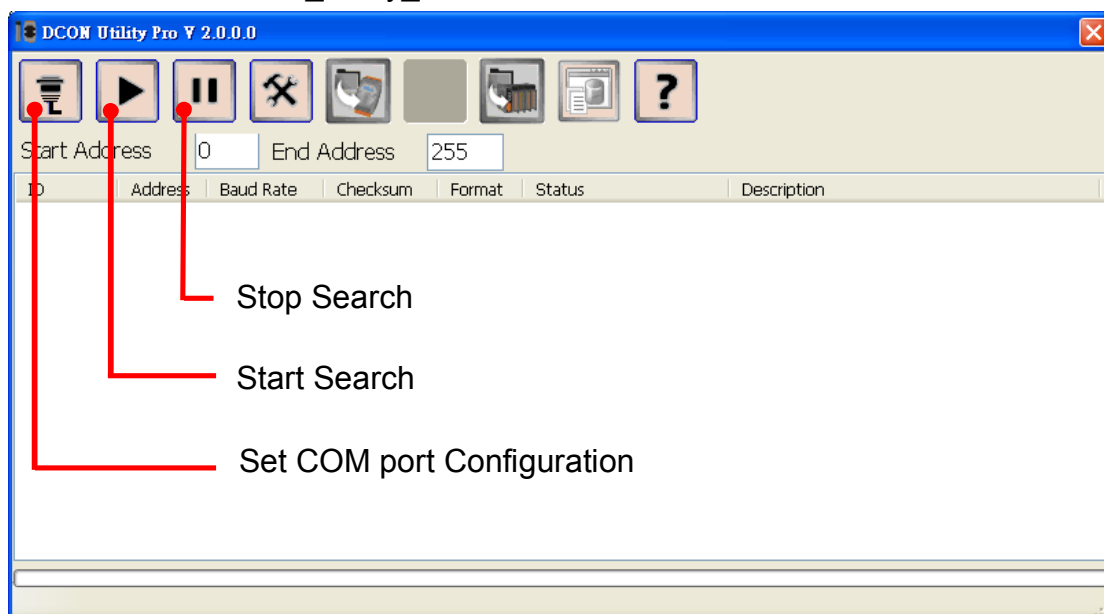

3. Click the icon  to configure the COM port.

4. Select the COM Port number used to connect the iSN-101 logger.

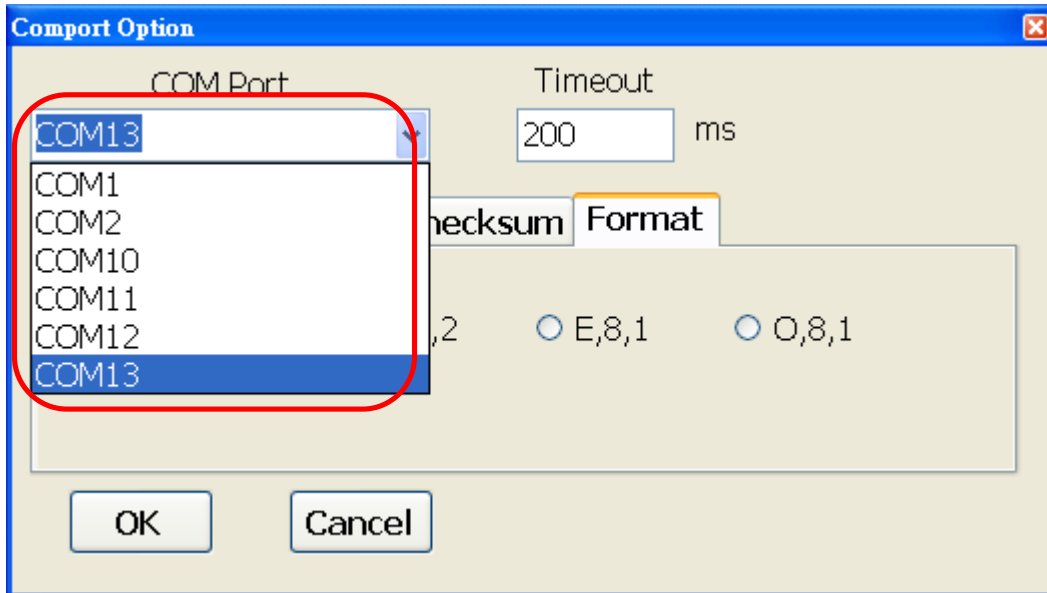

5. The Baud Rate is factory default to 9600 bps.

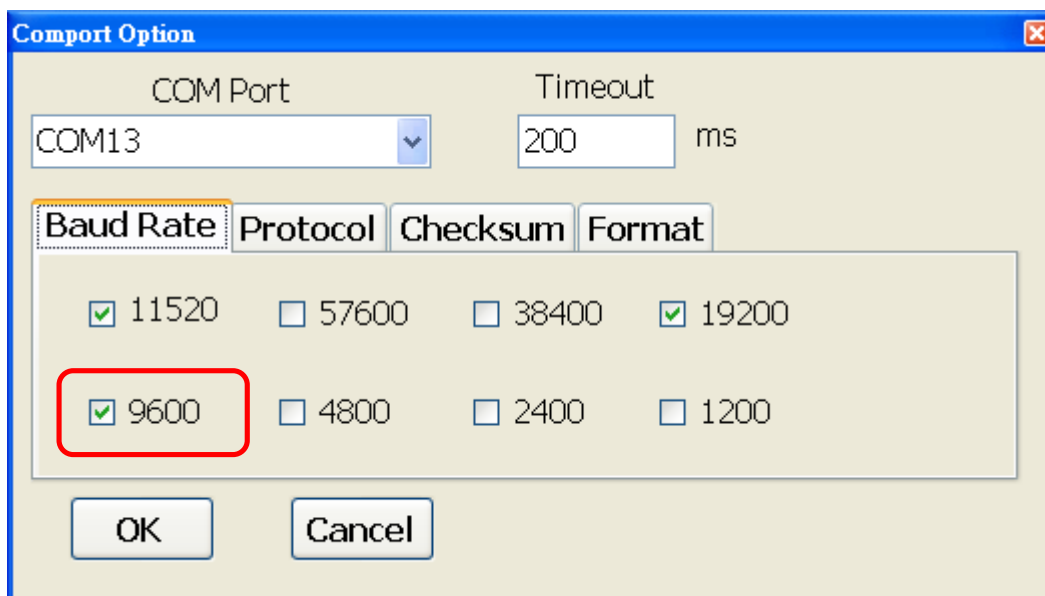

6. Select the Protocol tab.

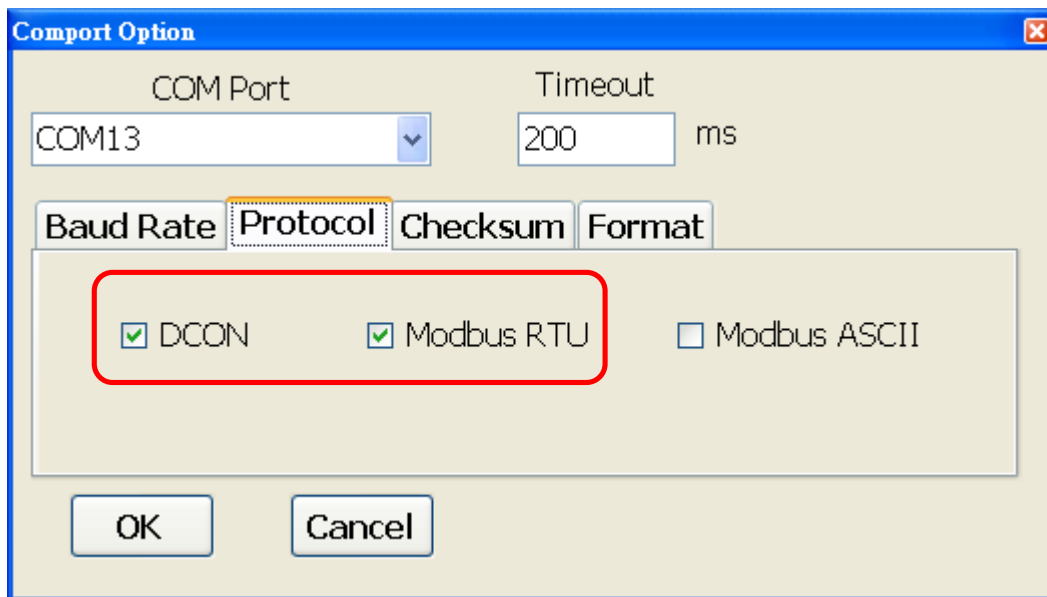

7. Select the Format tab and check the parity that set in the logger.

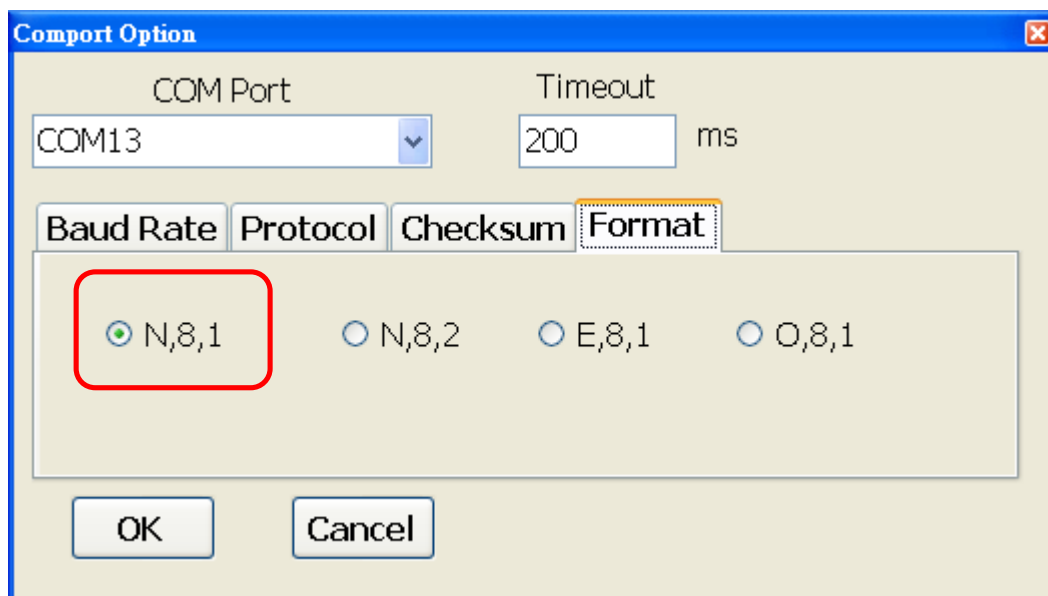

8. Click the Start Search icon.



9. The iSN-101 logger searched out will be listed as below.

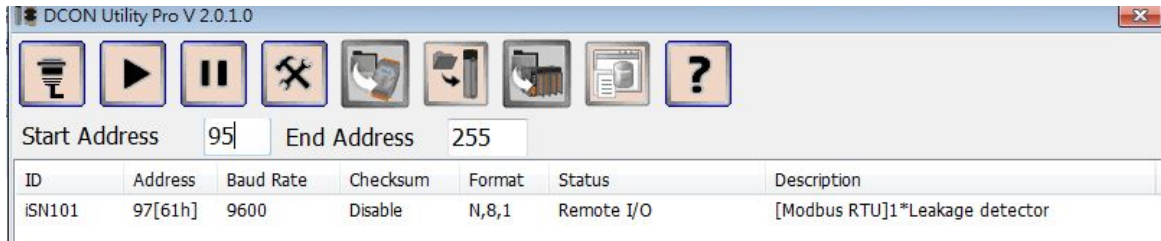

10. Click the module name to configure the logger.

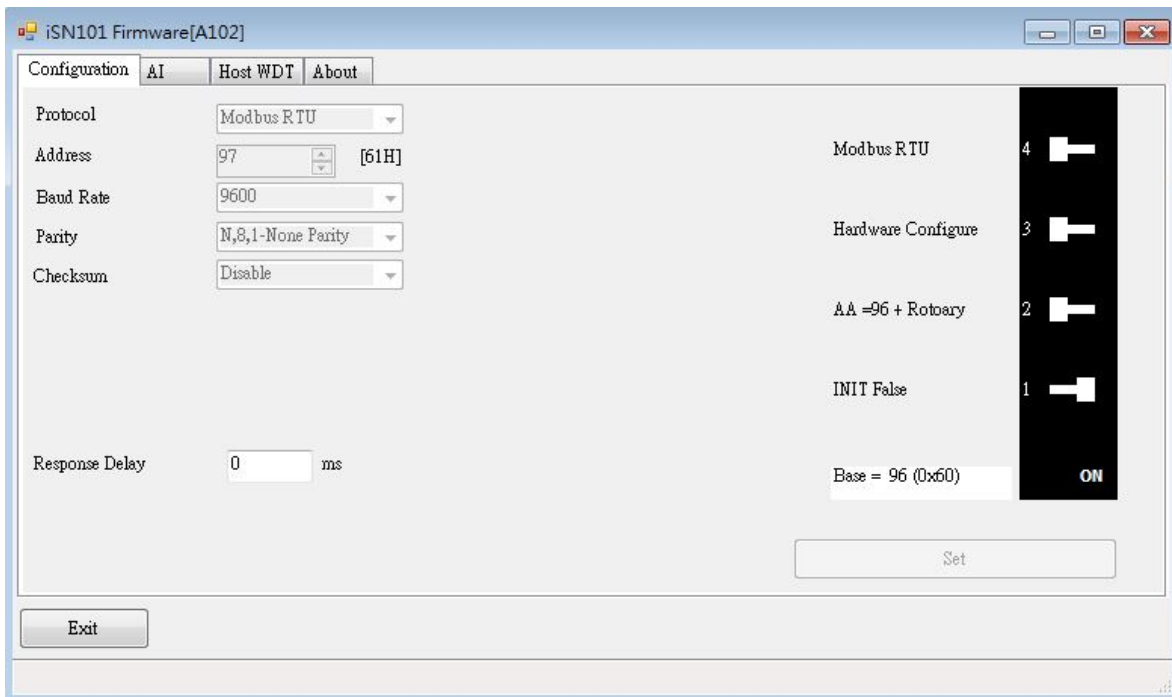

Note

The Protocol/Baud Rate/Parity/Checksum items marked with "(INIT*)" means that when any of those items needs be modified, the pin 4.INIT needs to be set in ON position and power cycle the logger, then the item can be modified. After complete setting, set the pin 4.INIT back to OFF position and power cycle the logger again to take the setting effect.

➤ **AI tab**

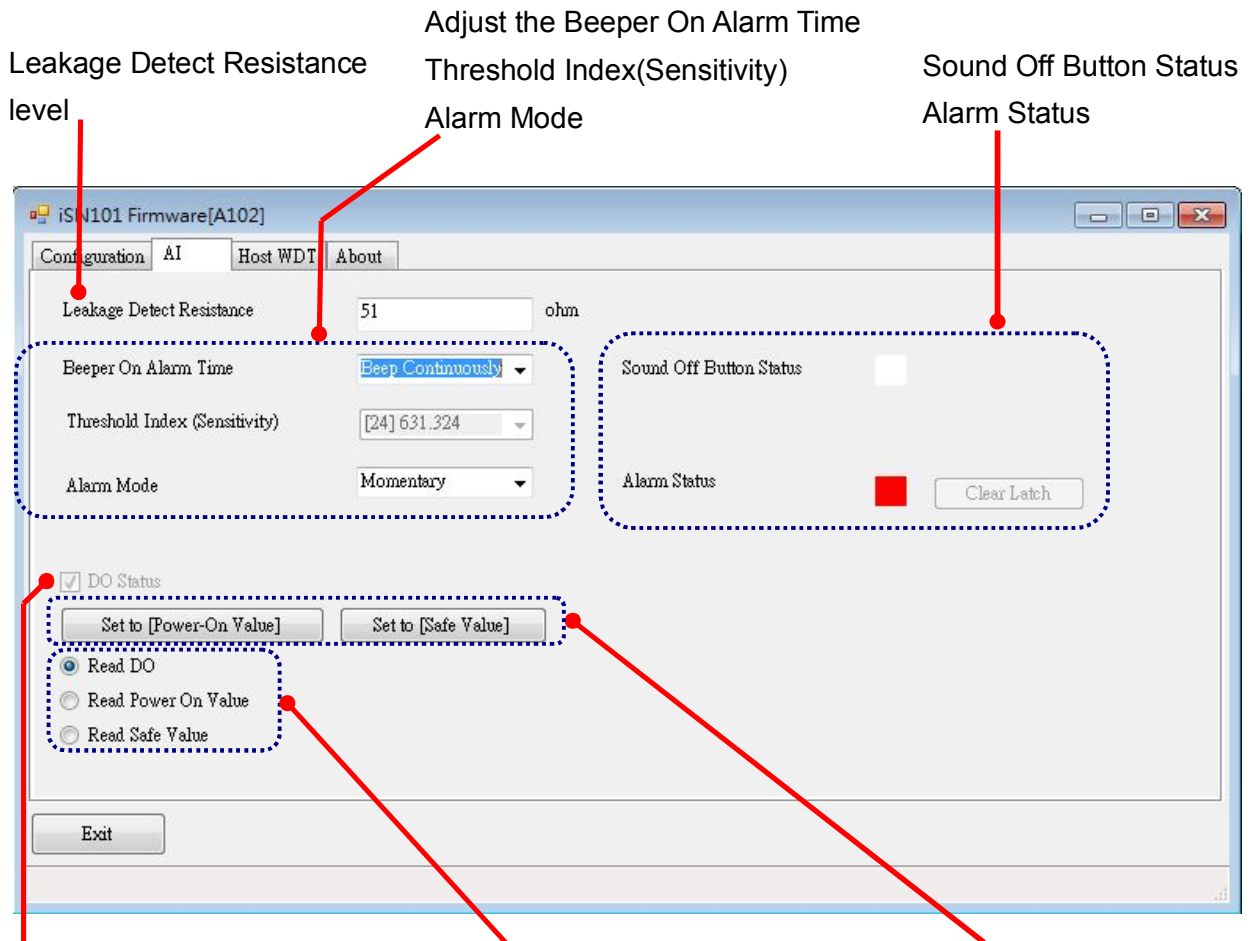

Leakage Detect Resistance level

Adjust the Beeper On Alarm Time

Threshold Index(Sensitivity)

Alarm Mode

Sound Off Button Status

Alarm Status

DO Status (On/Off)

Select one of the radio button and the checkbox next to DO will display the setting for selected item.

When the buttons are clicked, the DO status will be set as the Power On value or Safe value.

➤ **Host Watchdog**

Host Watchdog is used to monitor the RS-485 communication status; if the host (PC) does not send command “~**” in the time period of WDT Timeout setting, the enabled Host Watchdog will announce the timeout error and turn the relay output to Safe value to avoid an unsafe act. Users can not control the relay until the command “~AA1” is sent to clear the WDT timeout status.

On this tab:

1. Set the time period for WDT timeout, check the checkbox next to Enable WDT and click the Set WDT button to enable the Host watchdog.
2. Check the checkbox next to Send Host OK to send the “~**” command.
3. Uncheck the checkbox next to Send Host OK to stop sending ~** command, the Host watchdog timeout will occur and relay will turn to Safe value.
4. Click the Reset WDT button to clear the Host watchdog timeout status.
5. Uncheck the checkbox next to Enable WDT and click the Set WDT button to disable the Host watchdog.

Note

The relay will not turn to Safe value when alarm for detected liquid is enabled. If the alarm is enabled, the relay will be linked to the Alarm status. In case an Alarm occurs, the relay turns ON, it can be used to turn on the user’s alarm light or beeping alarm or other device.

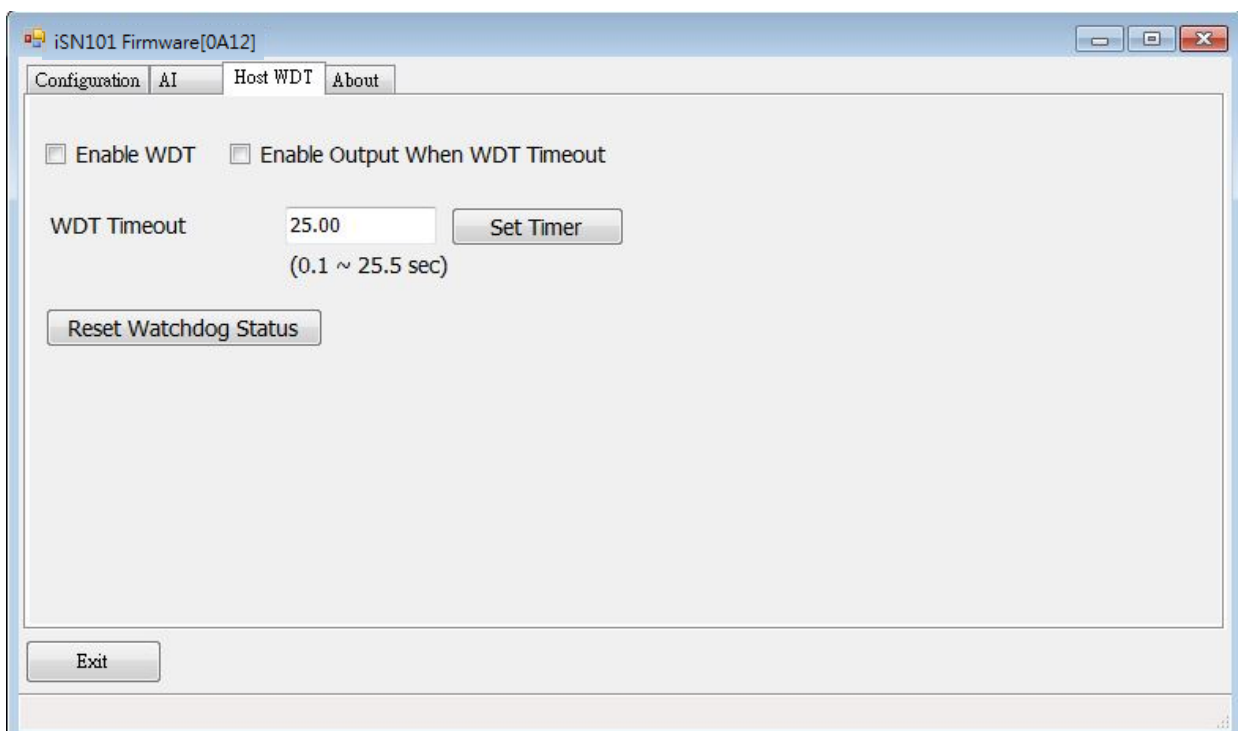

➤ INIT

In case of the following situations, users have to set the pin 4.INIT on SW1 in the ON position and power-cycle the iSN-101 module:

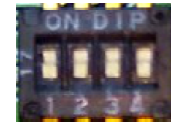

- Change protocol from PC
- Change DCON configuration such as baud rate, parity and checksum
- Communication failure with a iSN-101 module.

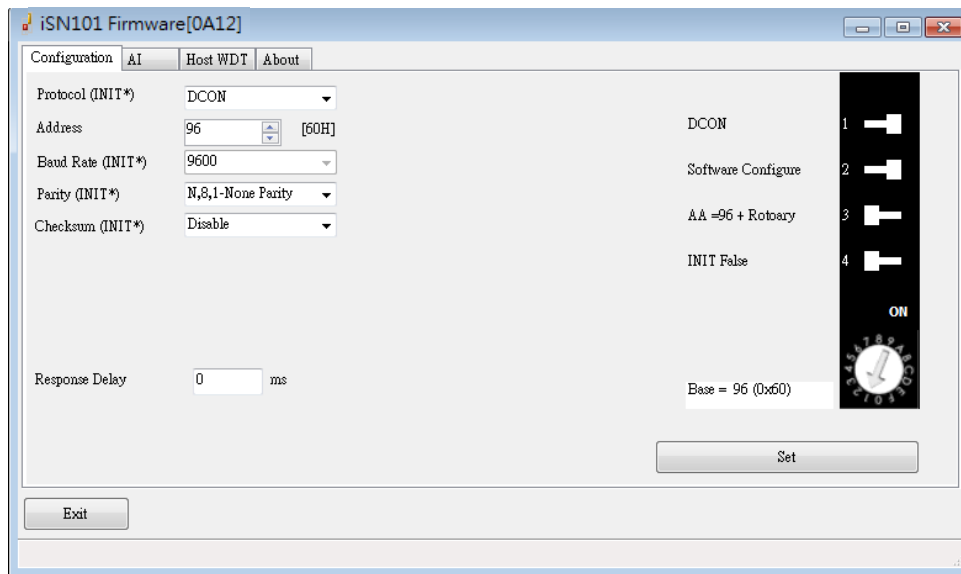

When a iSN-101 module is powered-on with the pin 4.INIT in ON position, the protocol is DCON, address is 0, Baud Rate is 9600 bps, Parity is set to N/8/1 and Checksum is disabled.

After configuring the communication parameters, click the *Set Module Configurations* button, set the INIT to OFF position and power-cycle the iSN-101 to take the settings effect.

Note

The INIT switch does not need to be set in the ON position when changing the address, baudrate and parity for ModbusRTU communication; users only have to power-cycle the module after complete configuration.

Appendix A: DCON Command Sets

A-1. iSN-101 DCON Command Sets

Command	Description
#AA	Read All Analog Inputs response >(resistance in k ohm)(threshold index by VR) in engineering format
#AAi	Read Channel Analog Inputs i = 0 for resistance in k ohm, 1 for threshold index by VR
@AABA	Read beep on alarm time response !aahh, hh in hex, 0: disabled, 1 ~ 250: beep on alarm time in seconds, 251: beep on alarm continuously
@AABAh	Set beep on alarm , hh in hex, 0: disabled, 1 ~ 250: beep on alarm time in seconds, 251:beep on alarm continuously
@AACH	Clear all high latch (to current)
@AACHi	Clear channel high latch (to current) N = 0 for resistance in k ohm, 1 for threshold index by VR,
@AACL	Clear all low latch (to current)
@AACLi	Clear channel low latch (to current) N = 0 for resistance in k ohm, 1 for threshold index by VR,
@AACLC0	Clear low latched alarm of channel 0
@AADAC0	Disable AI alarm of channel 0
@AADI	Read DI & DO Response !AA0OOI
@AADOhh	Set DO
@AAEATCi	Enable AI alarm of channel i, T->M: momentary alarm, L: latched alarm
@AAIL	Read IIR level
@AAILh	Set IIR level
@aaLT	Read leak threshold index
@aaLTV	Read leak threshold index by VR
@aaLTxx	Set leak threshold index, xx in hex, 00 ~ 18
@AARACi	Read AI alarm enabled/disabled status of channel 0

	Response !AA n, 0: disabled, 1: momentary, 2: latched
@AARAO	Read AI alarm status response !AAHLL
@AARH	Read all high latch values
@AARHi	Read channel high latch value
@AARL	Read all low latch values
@AARLi	Read channel low latch value
%AANNTCCFF	Set configuration FF: bit 6: 1-> checksum enabled
\$aa0Ci	Span calibration
\$aa1Ci	Zero calibration
\$aa2	Read configuration
\$aa5	Read reset status
\$aaF	Read firmware version
\$aaI	Read INIT status
\$aaM	Read module name
\$aaPN	Set Modbus RTU/DCON protocol
\$aaP	Read Modbus RTU/DCON protocol
\$aaS1	Reload factory calibration parameters
~aaAi	Read ADC raw data
~aaE0	Disable calibration
~aaE1	Enable calibration
~aaI	Soft INIT
~aaM	Read OEM module name
~aaO(data)	Set module name
~aaRD	Read response delay time in ms
~aaRDxx	Set response delay time in ms, xx in hex, 00 ~ 1E
~AARS	Read DIP switch Response !AAdddd (rotary, DIP switch)
~aaSR	Software reset
~aaTxx	Set soft INIT timeout in s, xx in hex
~aa0	Read host watchdog status
~aa1	Clear host watchdog timeout status
~aa2	Read host watchdog setting
~aa3ett	Set host watchdog setting
~aa4	Read power on and safe DO Response !AAPPSS
~aa5PPSS	Set power on and safe DO

Baud Rate Setting (CC)

Bits 5:0

Baud rate, 0x03 ~ 0x0A

Code	0x03	0x04	0x05	0x06
Baud	1200	2400	4800	9600
Code	0x07	0x08	0x09	0x0A
Baud	19200	38400	57600	115200

Bits 7:6

00: no parity, 1 stop bit

01: no parity, 2 stop bits

10: even parity, 1 stop bit

11: odd parity, 1 stop bit

Data Format Setting (FF)

Bit 6

0: checksum disabled

1: checksum enable

Appendix B: ModbusMasterToolPC

ModbusMasterToolPC is a free, easy-to-use tool for Modbus communication and diagnosing the wiring. It is located in the company CD:

CD:\Napdos\iSN-101\utility\ and needless to install

This section intends to guide the steps for creating the Modbus communication with iSN-101 logger.

1. Launch the ModbusMasterToolPC.exe.
2. Select **New** in the File menu.

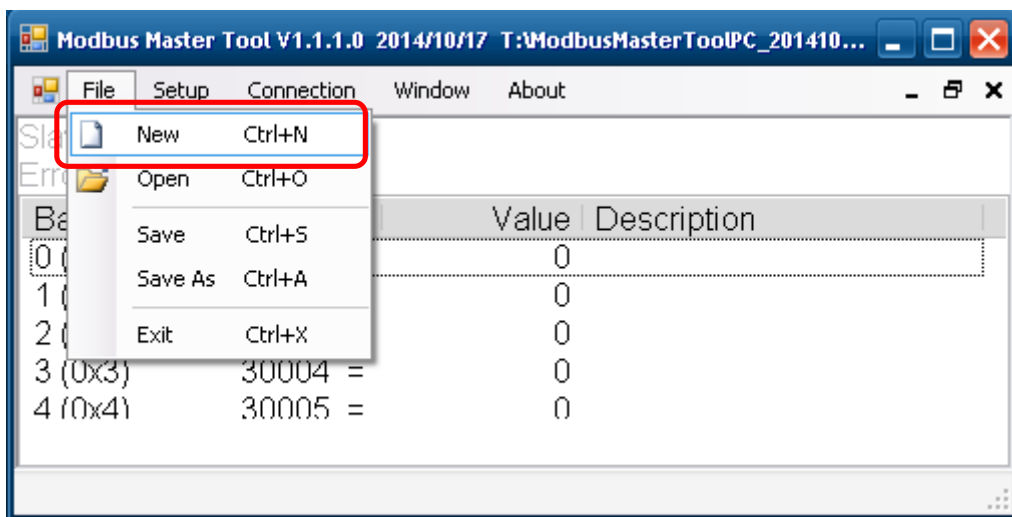

3. Input the file name and click on the **Save** button.

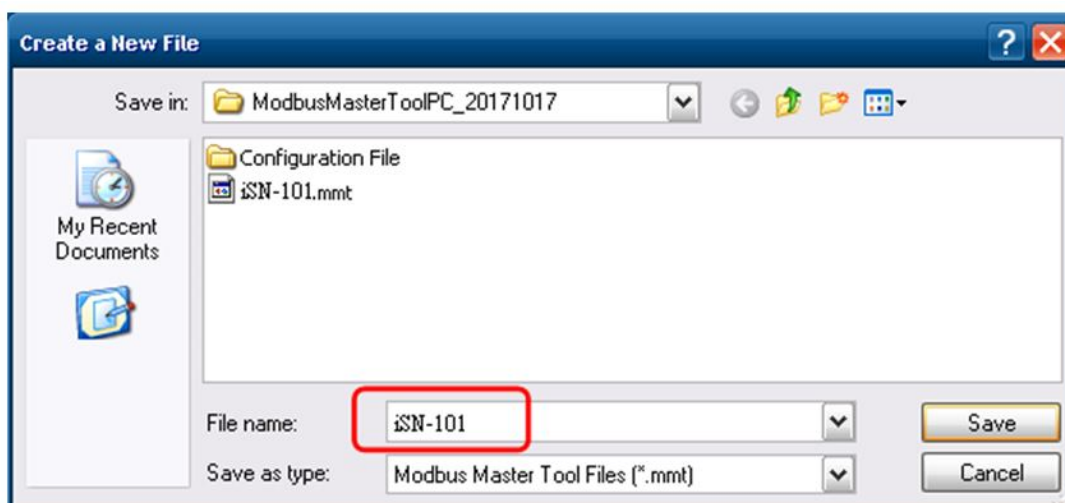

4. Select **Connect** in the *Connection* menu.

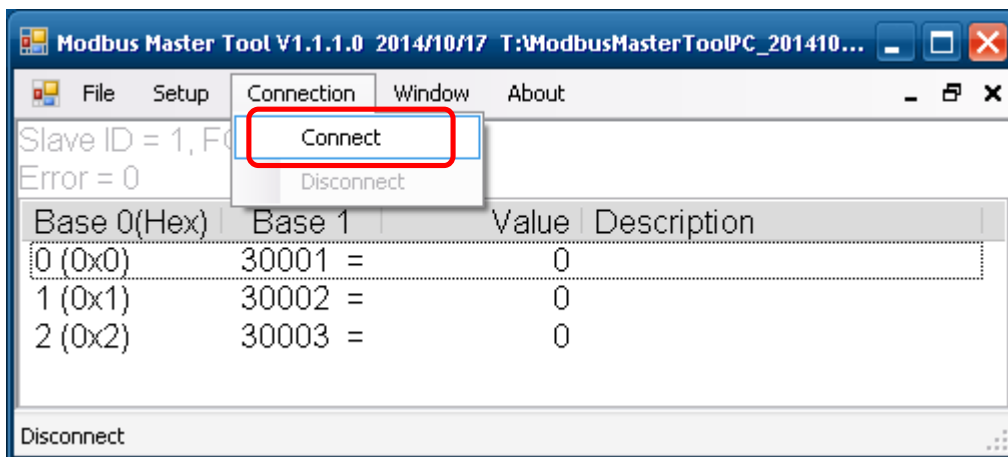

5. Select the communication interface. When using RS-485 as the interface, select the COM port, check the RTU mode and click on the **OK** button.

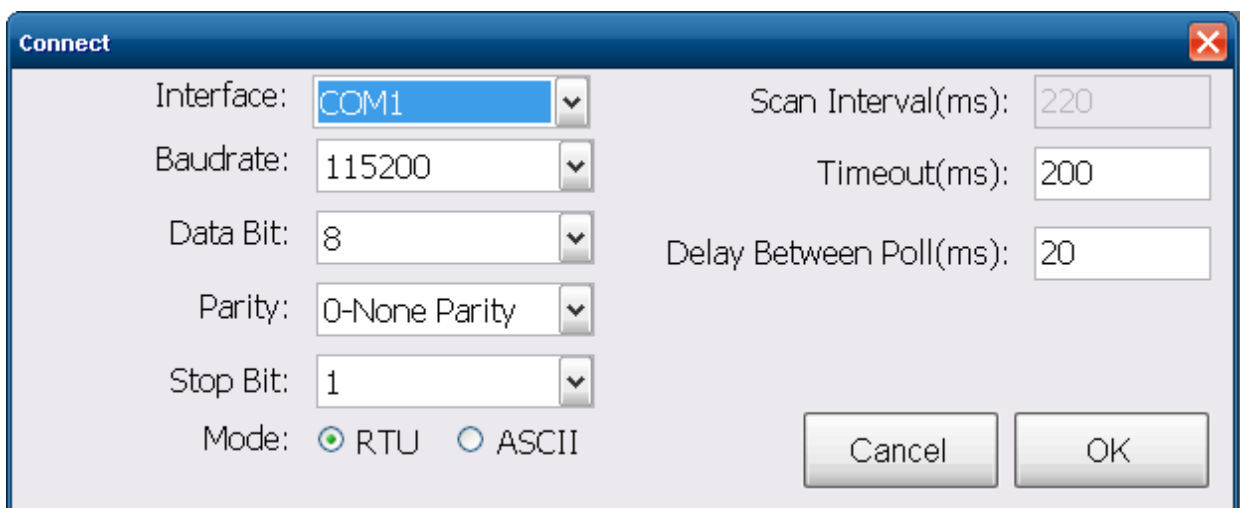

6. Select **Definition** in the *Setup* menu.

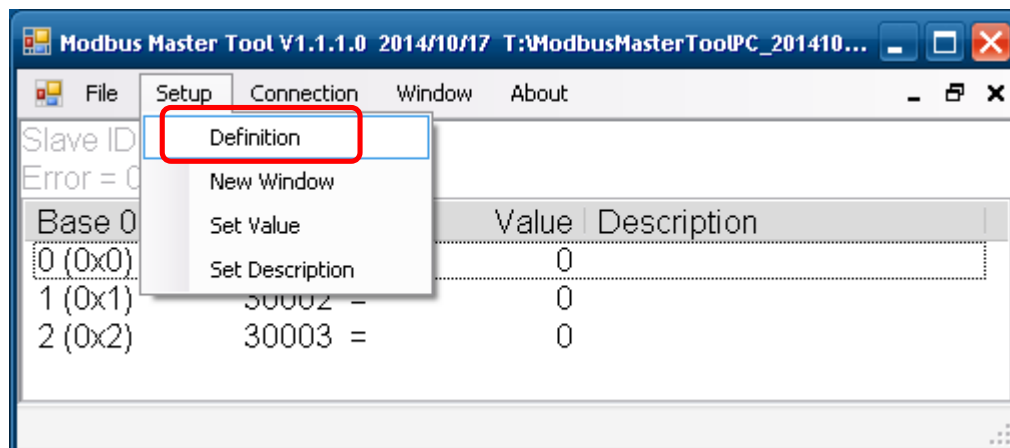

7. Select the Modbus function code, input the start address and length, and click on the **OK** button.

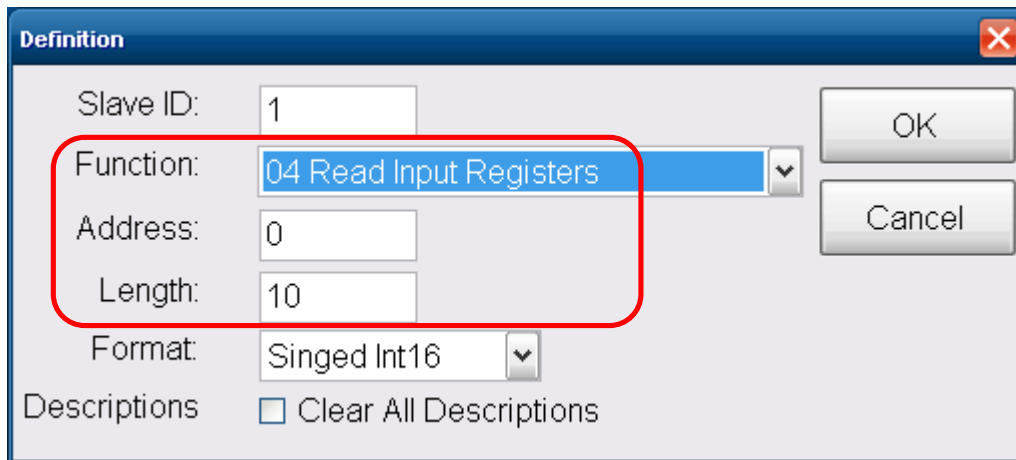

Definition

Slave ID: 1

Function: 04 Read Input Registers

Address: 0

Length: 10

Format: Singed Int16

Descriptions Clear All Descriptions

OK

Cancel

8. Read data.

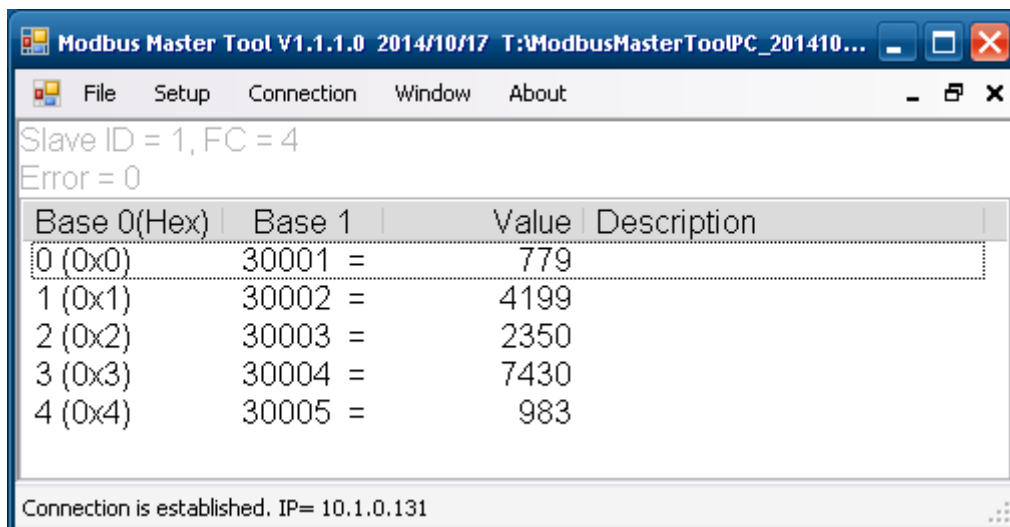

Modbus Master Tool V1.1.1.0 2014/10/17 T:\ModbusMasterToolPC_201410...

File Setup Connection Window About

Slave ID = 1, FC = 4
Error = 0

Base 0(Hex)	Base 1	Value	Description
0 (0x0)	30001 =	779	
1 (0x1)	30002 =	4199	
2 (0x2)	30003 =	2350	
3 (0x3)	30004 =	7430	
4 (0x4)	30005 =	983	

Connection is established. IP= 10.1.0.131

9. Write data to Holding Register or Coil Status

1. Highlight the Modbus address in the Holding Register or Coil Status list
2. Select **Set Value** in the *Setup* menu.
3. Input the data in the Value box and click on the **OK** button

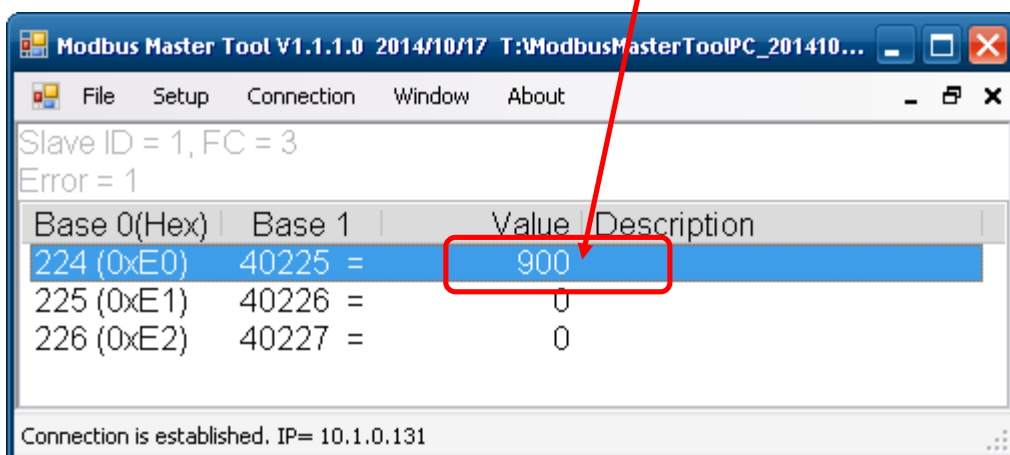
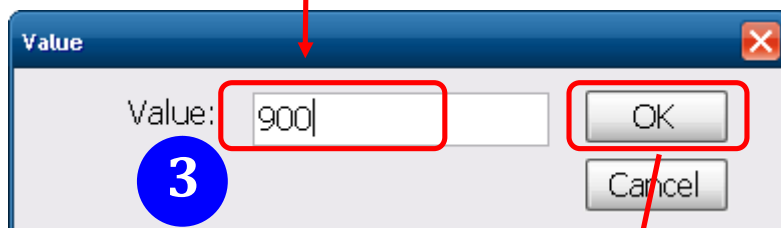
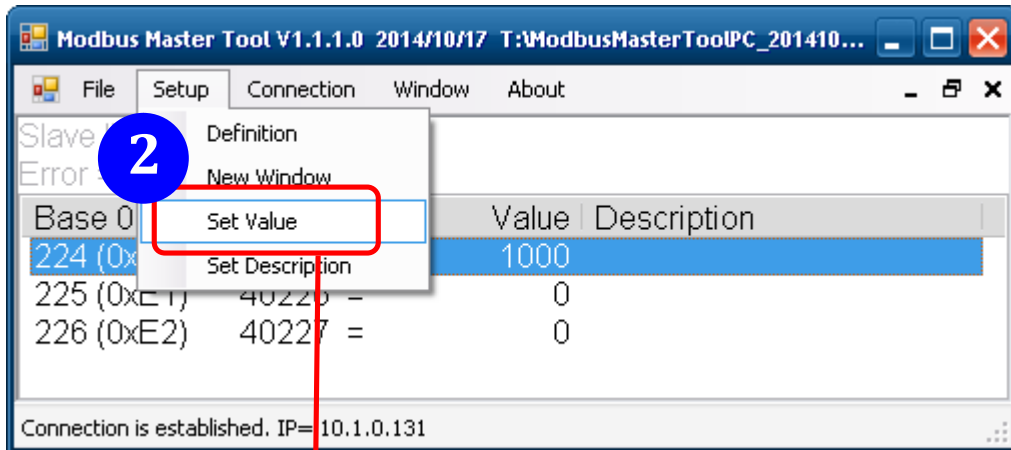

Appendix C: Modbus Address Table

C-1. iSN-101 Modbus Address Mappings (Base 1)

Address	Description	Attribute
30001 40001	Resistance of sensor in 100 ohm	R
30002 40002	Leak threshold index by VR, 0 to 24	R
40481	Firmware version (low word)	R
40482	Firmware version (high word)	R
40483	Module name (low word)	R
40484	Module name (high word)	R
40485	RS-485 module address, 1 to 247	R/W
40486	RS-485 baud rate and parity settings Bits 5:0 Baud rate, valid range: 3 ~ 10 Bits 7:6 00: no parity, 1 stop bit 01: no parity, 2 stop bit 10: even parity, 1 stop bit 11: odd parity , 1 stop bit	R/W
40488	RS-485 response delay time in ms, valid range, 0 ~ 30	R/W
40489	RS-485 host watchdog timeout value, 0 ~ 255, in 0.1s	R/W
40492	RS-485 host watchdog timeout count, write 0 to clear	R/W
40496	Leak threshold index, 0 to 24	R/W
40497	Beep on alarm, 0: disable, 1 to 250: beep on alarm time in seconds, 251: beep on alarm continuously	R/W
30513 40513	High latched analog input value of resistance of sensor in 100 ohm	R
30545 40545	Low latched analog input value of resistance of sensor in 100 ohm	R

Address	Description	Attribute
00001	Digital output value of channel 0	R/W
00033 10033	Status of the beep off switch	R
00129	Safe value of digital output channel 0	R/W
00161	Power on value of digital output channel 0	R/W
00257	Protocol, 0: DCON, 1: Modbus RTU	R/W
00260	Modbus RTU host watchdog mode 0: same as I-7000 1: can use AO and DO command to clear host watchdog timeout status Only for Modbus RTU protocol	R/W
00261	RS-485 host watchdog mode, 1: enable, 0: disable. Only for Modbus RTU protocol	R/W
00262	Write 1 to play notification sound	W
00270	Host watch dog timeout status, write 1 to clear host watch dog timeout status Only for Modbus RTU protocol	R/W
00273	Reset status, 1: first read after powered on, 0: not the first read after powered on	R
00280	Write 1 to clear all high latched analog input values	W
00281	Write 1 to clear all low latched analog input values	W
00289	Low alarm status of sensor. Write 1 to clear low latched alarm.	R/W
00321	Enable/disable alarm of sensor channel	R/W
00337	Alarm type, momentary or latched, of sensor channel	R/W
00385	Write 1 to clear high latched analog input value of sensor channel	W
00417	Write 1 to clear low latched analog input value of sensor channel	W

DIP Switch setting

1	Protocol	ON: DCON, OFF: Modbus RTU
2	Configuration	ON: by software, OFF: by hardware
3	Address	ON: added by 16, OFF: added by 0
4	INIT mode	ON: INIT, OFF: Normal

Base address: 96 (0x60)

Revision History

Revision	Date	Description
1.0.0	2017/10	First released