

ioPAC 8600 Series Quick Installation Guide

Version 1.2, January 2021

Technical Support Contact Information

www.moxa.com/support

MOXA[®]

© 2021 Moxa Inc. All rights reserved.

P/N: 1802086000012



Introduction

The ioPAC 8600 modular programmable controller supports CPU, power, backplane, and I/O modules, giving users greater flexibility for selecting the best module for different applications. The controllers have 5, 9, or 12 I/O slots and support both 85M series and 86M series modules. The ioPAC 8600 supports C/C++ and IEC 61131-3 programming capability, rail-level surge and ESD protection, a -40 to 75°C operating temperature range, anti-vibration, hot-swappability of modules, as well as two 10/100 Mbps Ethernet ports with two MACs (Port Trunking ready) or Ethernet bypass function with one MAC. With Moxa's MX-AOPC UA Suite, the ioPAC 8600 series provides a comprehensive solution for data acquisition and control applications in harsh environments.



ATTENTION

If the equipment is used in a manner not specified by the manufacturer, the protection provided by the equipment may be impaired. The manufacturer is not responsible for accidents caused by improper use of the equipment.

Package Checklist

- 1 x ioPAC 8600 CPU module
- 1 x console cable
- 1 x quick installation guide (printed)

Appearance

ioPAC 8600 CPU Module

ioPAC 8600-RJ45

ioPAC 8600-M12

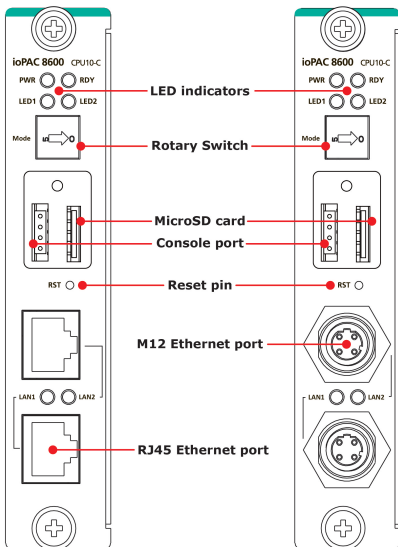

ioPAC 8600 Power Module

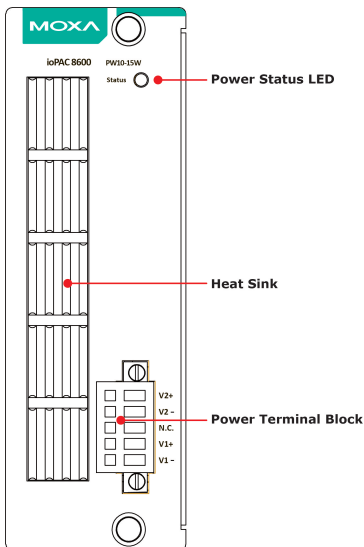

Installation

Wall-mounting Kit

STEP 1: Use screws to attach the wall-mounting kit to the back of the ioPAC 8600, as shown below:

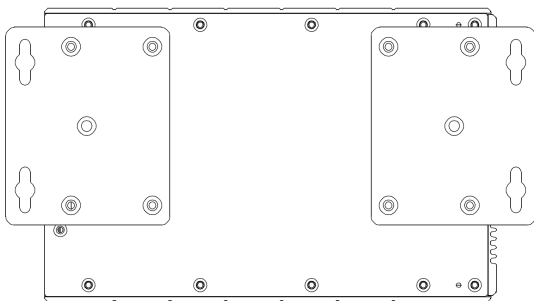

STEP 2: Use screws to fix the wall mounting kit to a wall.

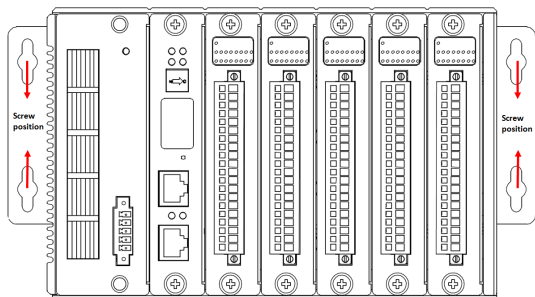

Module Installation (Power-Off)

The module's PCB should align with the edge of the frame. Push the module into the slot and make sure the module is plugged into the backplane. Fasten the two screws using 3.5 ± 0.5 kgf-cm of torque.

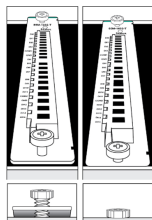

Module Installation (Power-On)

The module's PCB should align with the edge of the frame. Push the module into the slot and make sure the module is plugged in to the backplane. Fasten the two screws using 3.5 ± 0.5 kgf-cm of torque. It could take about ten seconds for the system to recognize and activate the module, at which point the module's LED will turn green.



ATTENTION

When the system is powered on, do not install more than one module at a time. If you need to install multiple modules, wait until the most recently installed module's LED turns GREEN before installing the next module.

Connecting the Power

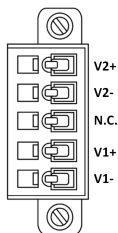

A 24 to 110 VDC input power is applied to the positive (V1+ and V2+) and negative (V1- and V2-) terminals on the connector.

SD Card Installation

1. Remove the screw holding the microSD card cover in place.
2. Insert the microSD card into the microSD card slot.
3. Use the holding screw to fasten the cover in place.

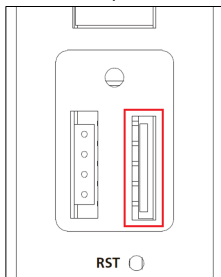
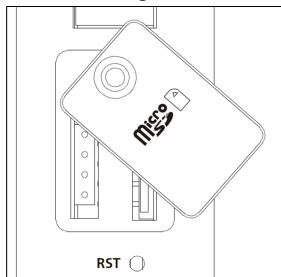

LED Indicators

Category	Label	Usage	Description
System	PWR	CPU Power	On: Power On Off: Power Off
	RDY	System Ready (Kernel)	Green: System Ready Green Blinking: System Booting-up Red: System Error/Executing Factory Default Red Blinking: Triggering Factory Default
		Firmware Upgrade Mode (rotary switch mode 9)	Green: Firmware Upgrade Success Green Blinking: Upgrading Firmware Red Blinking: Firmware Upgrade Error
C/C++ Version	LED1, LED2	User-defined	User-defined
IEC Version	R/S	Run/Stop Mode	Green: The CPU is running Off: The CPU is idle
	ERR	Error	Red: System, I/O, or Service Error Off: No Error
Communication	LAN1, LAN2	Ethernet Communication	Green: 100 Mbps Amber: 10 Mbps Blinking: Transmitting Data Off: Disconnected

Rotary Switch

Rotary Switch Position	Mode of Operation	Description
IEC Version: 0	RUN mode	RUN mode is the default operation mode. Use this mode for most tasks and configurations. The CPU will run automatically in this mode (this function should be enabled in RTUxpress).
IEC Version: 1	STOP mode	Stop the CPU (this function should be enabled in RTUxpress).
C/C++ Version: 0 to 4 IEC Version: 2 to 8	Reserved	

Rotary Switch Position	Mode of Operation	Description
C/C++ Version: 5 to 8	User-defined	
9	Firmware upgrade mode (only available when booting up)	<p>Use this mode to update the firmware from the SD card.</p> <ol style="list-style-type: none"> 1. Save the firmware file in the root folder of the microSD card. The filename must be rtu.hfm. 2. Stop the ioPAC and insert the SD card. 3. Turn the rotary switch to position 9 and then power up the ioPAC. 4. When the upgrade is complete, turn the rotary switch to 0 and reboot the ioPAC. <p>Note: For detailed information, see the section Upgrading the Firmware from the SD Card in the ioPAC 8600 SW User's Manual.</p> <p>Note: The microSD card should be FAT32 format.</p>

Connecting to the ioPAC 8600 Series Controller

Use the following configuration information to log in to the ioThinX 4530 Series controller:

Port	Default IP	Subnet Mask
LAN1	192.168.127.254	255.255.255.0
LAN2	192.168.126.254	255.255.255.0

- Username: moxa
- Password: moxa

NOTE Be sure to configure the host PC's IP address to use the same subnet as the unit. For example, 192.168.127.253 for LAN1 port.

Ethernet Connection

RJ45 Pin Assignment

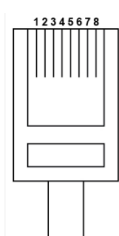

Contact	Media Direct Interface Signal
1	Tx+ (transmit)
2	Tx- (transmit)
3	Rx+ (receive)
4	Not used
5	Not used
6	Rx- (receive)
7	Not used
8	Not used

M12 Pin Assignment

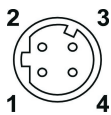

Pin	Connection
1	Tx+
2	Rx+
3	Tx-
4	Rx-

Serial Connection

Remove the SD card cover and attach the 4-pin console cable to the console port.

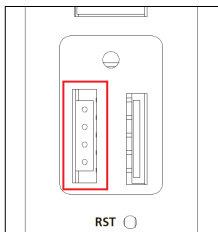

Serial Console Port Pin Assignment

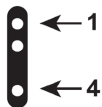

Pin	Definition
1	TxD
2	RxD
3	NC
4	GND

Serial Console Settings

Parameter	Value
Baudrate	115200 bps
Parity	None
Data bits	8
Stop bits	1
Flow Control	None
Terminal	VT100

Loading the Factory Default Settings

1. Turn the rotary switch to position 0.
2. When the system is booting up and the RDY LED is blinking GREEN, hold the reset button.
3. Continue to hold the reset button until the "RDY" LED turns a solid RED, and then release the reset button. It will take around 90 seconds to complete the factory reset process.
4. When the "RDY" LED starts blinking GREEN (indicating that the kernel is rebooting), the factory reset is completed.

How to Download the Software

Related software packages can be downloaded from the Moxa website.

Step 1: Go to the following address:

<https://www.moxa.com/en/support>

Step 2: Select a product list from the drop-down box or type the model name in the search box. In the following screenshot, the ioLogik E1200 Series is used to illustrate.

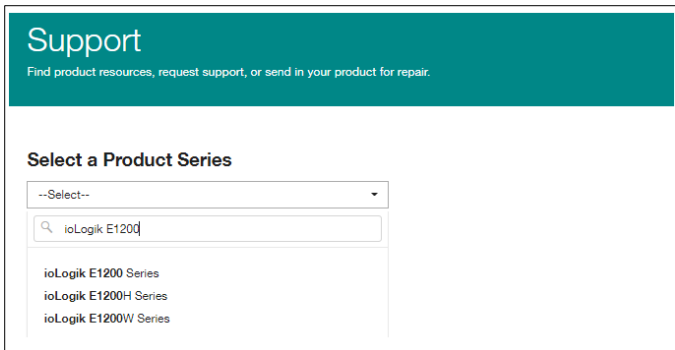

Step 3: Go to the Software & Documentation page to download the latest software for the product.

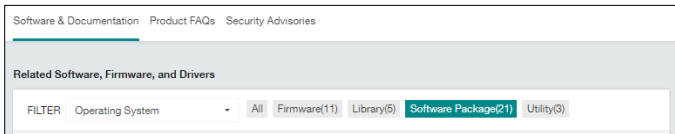

Specifications

Input Current	223 mA @ 24 VDC
Input Voltage	24 to 110 VDC
Operating Temperature	-40 to 75°C (-40 to 167°F)
Storage Temperature	-40 to 85°C (-40 to 185°F)